



MITHU BROTHERS

SURGICAL INSTRUMENTS CATALOGUE



Dear Valued Buyers

We feel immense pleasure to present our latest catalogue in which we have featured a most comprehensive range of all types of quality Surgical & Dental instruments required for day to day use for Hospital. We will be pleased to quote you a competitive Price and Delivery time.

All instruments are manufactured according to the recognized standard patterns currently in use in Hospital throughout the world and are being produced under restrict control of experts to avoid any flaw and to refrain any complaint at any stage.

A group of very vast experienced persons in manufacturing handling our quality Control System.

Any instruments proven defective in workmanship or material will be replaced with out charges.

We express our thanks to all our customers for the confidence they have placed us in the past. We further assure them that we will continue our best efforts to gain their confidence in the future.

We are always at your service.

Chief Executive

MITHU BROTHERS

01 DIAGNOSTIC INSTRUMENTS	01 To 13
02 TROCARS, SUCTION TUBES & CANNULAS	14 To 23
03 SCALPEL HANDLE, SCALPEL BLADES, DISSECTING KNIVES & SAWS	24 To 32
04 GENERAL OPERATING SCISSORS	33 To 60
05 DRESSING & TISSUE FORCEPS	61 To 78
06 HAEMOSTATIC FORCEPS	79 To 100
07 NEEDLE HOLDERS	101 To 126
08 RETRACTORS	127 To 161
09 Plastic SURGERY INSTRUMENTS	162 To 181
10 BONE SURGERY INSTRUMENTS	182 To 234

11 NEUROSURGERY INSTRUMENTS	235 To 262
12 CARDIOVASCULAR & THORACIC INSTRUMENTS	263 To 284
13 OPHTHALMIC INSTRUMENTS	285 To 294
14 ENT SURGERY	295 To 337
15 INTESTINAL AND RECTAL INSTRUMENTS	338 To 354
16 UROLOGY INSTRUMENTS	355 To 368
17 GYNECOLOGY / OBSTETRICS INSTRUMENTS	369 To 408
18 LIPOSUCTION CANNULAS	409 To 421
19 HOLLOW WARES	422 To 431
20 INDEX	432 To 445

DIAGNOSTIC INSTRUMENTS

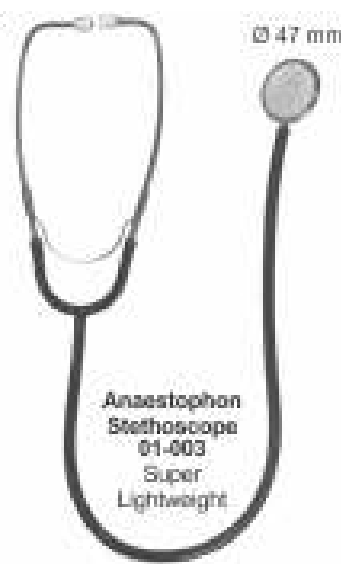




**Duplex
Stethoscope
01-001**
super
lightweight



**Duplex-Baby
Stethoscope
01-002**
super
lightweight



**Anaesthophon
Stethoscope
01-003**
Super
Lightweight



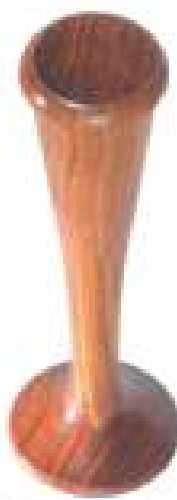
**Clar Mead Mirror
komplett
B-Voll
01-004**



**Ziegler
01-005**
Ø 90mm
with head band without
protection cap



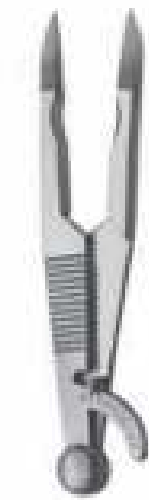
01-007
Ø 50mm



**Pinard Wooden
Stethoscope
01-008** 18 cm



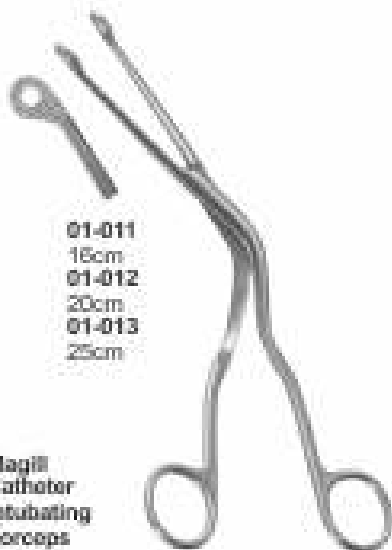
**Pinard Aluminium
Stethoscope
01-009** 15 cm



**Weber
Aesthesiometer
01-010** 9 cm



**Ziegler
01-006**
Ø 90mm
with head band with
protection cap



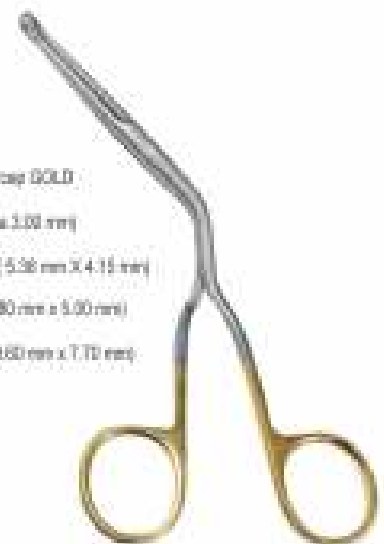
01-011
18cm
01-012
20cm
01-013
25cm

**Magill
Catheter
Intubating
Forceps**



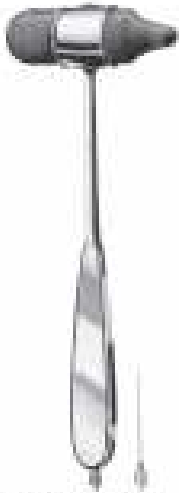
Magill Catheter Intubating Forceps Gold
01-014
6.5" (2.5" shaft) , Infant , hole (dia 2.00 mm)
01-015
7.5" (3" shaft) , Infant , hole (dia 2.30 mm)
01-016
7.5" (3" shaft) , Infant , hole (dia 2.60 mm)

Magill Catheter Intubating Forceps GOLD
01-017
6" (4" shaft) , Child , hole (dia 2.00 mm)
01-018
6" (4" shaft) , Child , oval tip (5.50 mm x 4.15 mm)
01-019
8" (5" shaft) , Adult , oval (4.80 mm x 5.00 mm)
01-020
10" (5" shaft) , Adult , oval (9.60 mm x 7.70 mm)

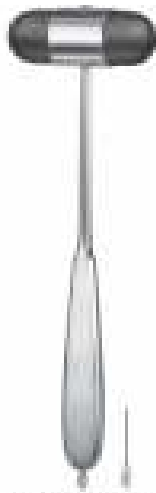


PERCUSSION HAMMERS

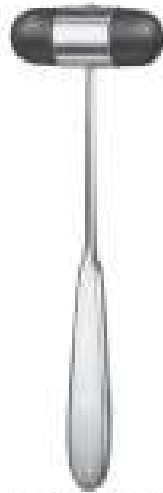
Perkussionshämmer | Martillos de percusión
 Marteaux-percuteurs | Martelli percussori



Neuro-Duoflex Hammer
01-021 22cm



Dejerine Hammer
01-022 20cm



Dejerine Hammer
01-023 20cm



Troemner Hammer
01-024 145 g
01-025 175 g
01-026 235 g
24.5 cm
spare rubber



Troemner-Simplex Hammer
01-027 21cm



Buck Hammer
01-028 18.5cm



Buck Hammer
01-029 18cm



Taylor Hammer
01-030 18cm
01-031 20cm



Taylor Hammer
01-032 19cm



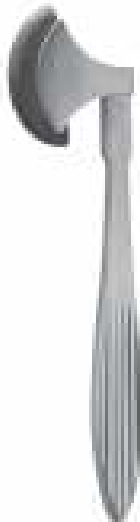
Babinsky Hammer
01-033 22 cm



Babinsky Hammer
01-034 22 cm



Rabiner Hammer
01-035 25.5 cm
with needle & brush



Berliner Hammer
01-036 20 cm

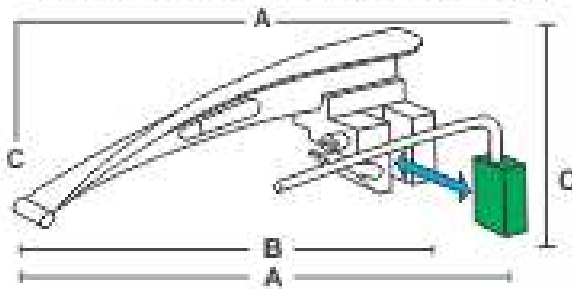


Traube Hammer
01-037 16 cm.



Wartenberg Pinwheel
01-038 19 cm

MC-INTOSH FIBER OPTIC LARYNGOSCOPE BLADE



BLADE

Size	A	B	C	Working Length
0	77mm	53mm	14mm	55mm
1	95mm	72mm	43mm	70mm
2	111mm	86mm	44mm	78mm
3	133mm	109mm	44mm	108mm
4	151mm	129mm	44mm	133mm

Mc-Intosh Laryngoscope Fiber Optic

Halogen Illumination, Manufactured from AISI 304 Stainless Steel, Halogen Illumination 2.5 V. The Bulb is inside the handle in order to simplify the sterilization of the blades. All blades and handles are interchangeable with other leading manufacturer. All sets can be combined as per your request, and delivered in Green plastic case.

Blades Availability:

- Matt Finish
- Mirror Finish
- Sand Blast Finish
- Plz, confirm in your order for

Mc-INTOSH FIBER OPTIC LARYNGOSCOPE SET HALOGEN ILLUMINATION

01-039 PEDIATRIC SET

Set of 0,1,2 Blades
Supplied in Green plastic case

01-040 STANDARD SET

Set of 1,2,3 Blades
Supplied in Green plastic case

01-041 ADULT SET

Set of 1,2,3,4 Blades
Supplied in Green plastic case



Laryngoscope Battery Handle for Adult
C type 2 batteries
01-047



Mc-Intosh Fiber Optic Laryngoscope Set
Halogen Illumination
Manufactured by AISI 304 Stainless Steel Material

Fig. 0
01-042

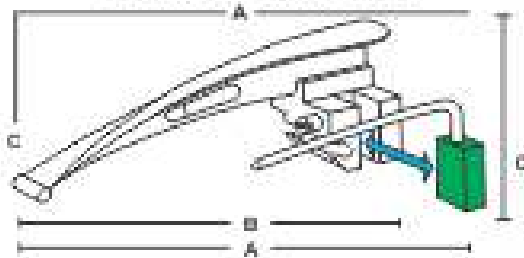
Fig. 1
01-043

Fig. 2
01-044

Fig. 3
01-045

Fig. 4
01-046

MC-INTOSH LARYNGOSCOPE



BLADE

Size	A	B	C	Working Length
0	77mm	53mm	14mm	55mm
1	95mm	72mm	43mm	70mm
2	111mm	86mm	44mm	78mm
3	133mm	109mm	44mm	108mm
4	151mm	129mm	44mm	133mm

Fiber Optic Laryngoscope

Plastic case, Halogen Illumination, Manufactured from AISI 304 Stainless Steel Halogen Illumination 2.5 V. The Bulb is inside the handle in order to simplify the sterilization of the blades. All blades and handles are interchangeable with other leading manufacturer. All sets can be combined as per your request, and delivered in Green plastic case.

Blades Availability:

- Matt Finish
- Mirror Finish
- Sand Blast Finish
- Plz, confirm in your order for



01-056
Laryngoscope Battery Handle for Adult
C type 2 Batteries



01-057
Laryngoscope Bulb Small



01-058
Laryngoscope Bulb Large



Mc-Intosh Laryngoscope Set of Fiber Optic Halogen Illumination
Manufactured From AISI 304 Stainless Steel Material

Fig. 0
01-051

Fig. 1
01-052

Fig. 2
01-053

Fig. 3
01-054

Fig. 4
01-055

Laryngoskope | Laringoscopes
Laryngoscopes | Laringoscopi

FIBER OPTIC LARYNGOSCOPE MILLER



BLADE

Size	A	B	C	Working Length
0	75mm	53mm	26mm	55mm
1	111mm	80mm	26mm	80mm
2	151mm	134mm	28mm	130mm
3	198mm	167mm	28mm	170mm
4	203mm	180mm	28mm	180mm



01-067
Laryngoscope Battery
Handle for Adult
C type 2 Batteries

FIBER OPTIC LARYNGOSCOPE MILLER AVAILABLE SETS WITH BATTERY HANDLE

01-059 PEDIATRIC SET
Set of 0,1,2
Blades
Supplied in Green plastic case

01-060 STANDARD SET
Set of 1,2,3
Blades
Supplied in Green plastic case

01-061 ADULT SET
Set of 1,2,3,4
Blades
Supplied in Green plastic case

Fig. 0
01-062

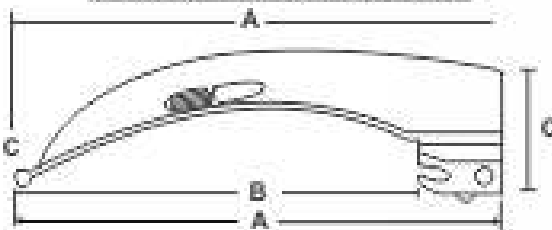
Fig. 1
01-063

Fig. 2
01-064

Fig. 3
01-065

Fig. 4
01-066

MC-INTOSH LARYNGOSCOPE



BLADE

Size	A	B	C	Working Length
0	80mm	58mm	30mm	55mm
1	97mm	76mm	36mm	70mm
2	111mm	88mm	36mm	78mm
3	133mm	112mm	36mm	108mm
4	154mm	131mm	38mm	133mm

Mc-Intosh Laryngoscope

Plastic case, Standard Illumination. Manufactured from AISI 304 Stainless Steel Matt Type, Standard Illumination 2.5 V. All blades and handles are interchangeable with other leading manufacturers. All sets can be combined as per your request, and delivered in Gray plastic case.

Blades Availability:

- Matt Finish
- Mirror Finish
- Sand Blue Finish
- Pls. confirm in your order for



01-077
With one Spare Bulb



01-076
Laryngoscope Battery
Handle for Adult
C type 2 Batteries

CONVENTIONAL LARYNGOSCOPE SET

Mc-INTOSH LARYNGOSCOPE SET STANDARD ILLUMINATION

AVAILABLE SETS WITH BATTERY HANDLE

01-068 PEDIATRIC SET
Set of 0,1,2 Blades
Supplied in Gray plastic case

01-069 STANDARD SET
Set of 1,2,3 Blades
Supplied in Gray plastic case

01-070 ADULT SET
Set of 1,2,3,4 Blades
Supplied in Gray plastic case

Fig. 0
01-071

Fig. 1
01-072

Fig. 2
01-073

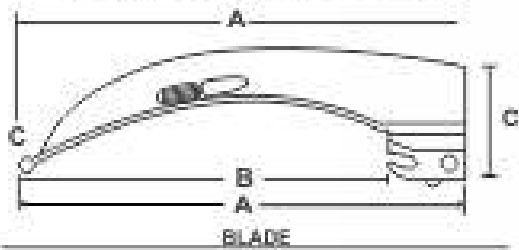
Fig. 3
01-074

Fig. 4
01-075



Mc-Intosh Laryngoscope Set
Standard Illumination
Manufactured From
Stainless Steel Material

MC-INTOSH LARYNGOSCOPE



Size	A	B	C	Working Length
0	80mm	58mm	30mm	55mm
1	97mm	76mm	36mm	70mm
2	111mm	88mm	36mm	78mm
3	133mm	112mm	36mm	108mm
4	154mm	131mm	38mm	133mm

Mc-Intosh Laryngoscope

Plastic case, Standard Illumination. Manufactured from AISI 304 Stainless Steel. All blades and handles are interchangeable with other leading manufacturer. All sets can be combined as per your request, and delivered in Blue plastic case.

Blades Availability:

- Matt Finish
- Mirror Finish
- Sand Blast Finish
- Pls. confirm in your order for



01-087
With two Spare Bulbs



01-086
Laryngoscope Battery Handle for Adult C type 2 batteries



CONVENTIONAL LARYNGOSCOPE SET

Mc-INTOSH LARYNGOSCOPE CONVENTIONAL STANDARD ILLUMINATION

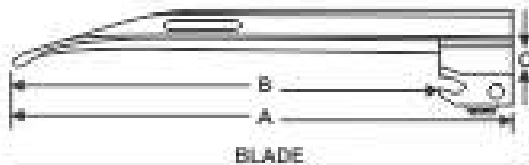
AVAILABLE SETS WITH BATTERY HANDLE

- 01-078 PEDIATRIC SET**
Set of 0,1,2 Blades.
Supplied in Blue plastic case
- 01-079 STANDARD SET**
Set of 1,2,3 Blades.
Supplied in Blue plastic case
- 01-080 ADULT SET**
Set of 1,2,3,4 Blades.
Supplied in Blue plastic case



Mc-Intosh Laryngoscope Conventional Standard Illumination
Manufactured From Stainless Steel material

LARYNGOSCOPE MILLER



Size	A	B	C	Working Length
0	75mm	53mm	26mm	55mm
1	111mm	80mm	26mm	80mm
2	151mm	134mm	28mm	130mm
3	188mm	167mm	28mm	170mm
4	203mm	180mm	28mm	180mm

Mc-Intosh Laryngoscope

Plastic case, Standard Illumination. Manufactured from AISI 304 Stainless Steel. All blades and handles are interchangeable with other leading manufacturer. All sets can be combined as per your request, and delivered in Blue plastic case.

Blades Availability:

- Matt Finish
- Mirror Finish
- Sand Blast Finish
- Pls. confirm in your order for



01-097
With two Spare Bulbs



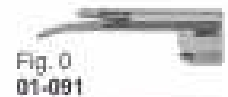
01-095
Laryngoscope Battery Handle for Adult C type 2 batteries

CONVENTIONAL LARYNGOSCOPE SET

LARYNGOSCOPE SET OF CONVENTIONAL MILLER STANDARD ILLUMINATION

AVAILABLE SETS WITH BATTERY HANDLE

- 01-088 PEDIATRIC SET**
Set of 0,1,2 Blades
Supplied in Blue plastic case
- 01-089 STANDARD SET**
Set of 1,2,3 Blades
Supplied in Blue plastic case
- 01-090 ADULT SET**
Set of 1,2,3,4 Blades
Supplied in Blue plastic case



Laryngoscope Set of conventional Miller Standard Illumination
Manufactured From Stainless Steel Material



Laryngoscope Flexible (Mc-Coy)



Available blade sizes 2,3 & 4 with
'AA' & 'C' type battery handles
01-100
01-101
01-102

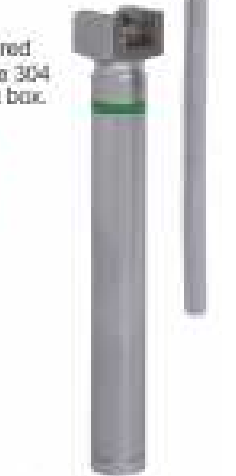
01-098

CONVENTIONAL SET
Flexible Laryngoscope
Conventional
Halogen Illumination
Manufactured From
Stainless Steel High
grade 304 material.

01-099
'C' type handle



Available Blade sizes 2,3 & 4 with
'AA' & 'C' type battery handles
01-105
01-106
01-107
01-103 FIBER OPTIC SET
Flexible Laryngoscope
Set of Fiber Optic
Halogen Illumination Manufactured
From Stainless Steel High grade 304
material packed in green plastic box.



Laryngoscope Battery
Handle for Adult
AA Batteries
01-104



DIAGNOSTIC PENTOSCOPE SET 01-108

2.5 V Standard Illumination for use with
2 batteries type AA.

Consisting:

Universal Handle thread type fit for all
Pentoscope Heads like.

- Oroscope Head.
- Ophthalmoscope Head.
- Throat Branch Head.
- Mouth Mirrors Head.

It have two exploring mirrors No. 4 & 5 mm.

Its spare-08 disposable Plastic ear Canulas are

with sizes 2 x 2.50 mm, 2 x 3.50 mm & 2 x 4.5 mm.

On special order it can be as 2 x 1.5 mm for new
born babies 2 x 2.5 mm for pediatric and 2 x 4 mm
for adults, so it means total 08 canula also available
in a plastic tube packing.

Sturdy adjustment mount bracket.

2 spare 2.5 V bulb.

Pentoscope set battery handle is operating with
two AA size batteries.

This Pentoscope set Packed in our new beautiful
Blue Colour plastic case in same blue inner packing material.

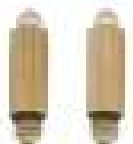
Spare parts also available of any item.



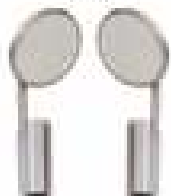
Standard
Illumination



Plastic ear Canulas



With 2 spare
Bulbs



Mouth Mirrors Head



Oroscope Head



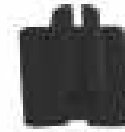
Sturdy Adjustment Mount Bracket



Handle



Two laryngeal mirrors: n. 4 and 5



Bent-arm illuminator:
pin contact fitting.



Specula



With 2 spare Bulbs

**Professional Otoscope & Ophthalmology Set
ENT Medical Diagnostic Set
01-109**

2.5 V Standard illumination for use with 2 batteries C type.

including:

Otoscope Head: Luir Lock fitting.

Chrome plated.

Fix lens 4 x in plastic mount can be removed for introduction of instruments.

Specula sizes: 2.5, 3.5 & 4.5 mm Included.

Ophthalmoscope head: Luir Lock fitting.

Lens selection wheel permits choice of corrective lenses from 0 to -20 and 0 to +20 diopters.

Single large circle aperture.

Bent-arm illuminator: pin contact fitting.

Nasal speculum: Chrome plated.

Two laryngeal mirrors: n. 4 and 5.

Battery handle: 28mm. For 2 cell C-batteries.

Chrome plated. For adjustment of all illumination.

Replacement bulb: 2.5 V

Diagnostic set is supplied in our new beautiful look and quality Blue Case, which protect our quality Products from moisturizing and damaging.



Otoscope Head



Nasal speculum: Chrome plated.



Ophthalmoscope head



ENT Specula



Two laryngeal mirrors: n. 4 and 5



Bent-arm illuminator: pin contact fitting.

**Universal Otoscope & Ophthalmology Set
ENT Medical Diagnostic Set
01-110**

2.5 V Standard illumination for use with 2 batteries type C.

Including:

Otoscope Head: Luir Lock fitting.
Chrome plated.

Fix lens 4 x in plastic mount can be removed for introduction of instruments.

Specula sizes: 2.5, 3.5 & 4.5 mm Included.

Ophthalmoscope head: pin contact fitting.

Lens selection wheel permits choice of corrective lenses from 0 to - 20 and 0 to +20 diopters.

Single large circle aperture.

Bent-arm illuminator: Luir Lock fitting.

Nasal speculum: Chrome plated.

Two laryngeal mirrors: n. 4 and 5.

Battery handle: 28mm. For 2 cell C-batteries.

Chrome plated. For adjustment of all illumination.

Replacement bulb: 2.5 V

The Diagnostic set is supplied in new beautiful look and quality Blue Case, which protect our quality Products from moisturizing and damaging.



Nasal speculum: Chrome plated.



ENT Specula



Otoscope Head



Ophthalmoscope Head



Handle

DIAGNOSTIC SETS

Diagnostik-Bestestecke
Trousse à diagnose

Juegos para diagnóstico
Astuca diagnóstica



Standard Otoscope + Ophthalmoscope Set
01-111

This Set is with 2.5V standard illumination, handle is chrome plated as well otoscope head too. Handle and head is Luer / Faster lock fitting. Head of otoscope is with 6x magnifying glass. 03 Reusable speculums with sizes 2.5, 3.5 & 4.5 mm. A Full Functional Ophthalmoscope compact durable, light weight. Standard bulb and precision system 4 different apertures selection range of lenses -20 to +20 bright white light and brilliant image A Full Functional Ophthalmoscope Battery handle for 2 'c' batteries. Rheostat for adjustment of illumination. Supply in Black Plastic Box Packing.



Otoscope
Head



ENT Specula



Ophthalmoscope
head



ENT Specula

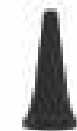


'C' type
Battery handle



Standard Ophthalmoscope Set
01-112

A Full Functional Ophthalmoscope compact durable, light weight. Standard bulb and precision system 4 different apertures selection range of lenses -20 to +20 bright white light and brilliant image Packed in Black Plastic Case.



Standard Otoloscope Set
01-113

this otoscope is with 2.5 V standard illumination, handle is chrome plated as well otoscope head too. Handle and head is Luer / Faster lock fitting. Head of otoscope is with 6x magnifying glass. 03 Reusable speculums with sizes 2.5, 3.5 & 4.5 mm. Battery handle for 2 'c' batteries. Rheostat for adjustment of illumination. Supply in Black Pouch Packing.



Ophthalmoscope
head



'C' type Battery Handle

Diagnostik-Bestestecke
Trousse à diagnose

Juegos para diagnóstico
Astucaí diagnòstic



**Standard Oscope Set
01-114**

This otoscope is with 2.5 V standard illumination, handle is chrome plated as well otoscope head too. Handle and head is Lull / Faster lock fitting. Head of otoscope is with 6x magnifying glass. 03 Reusable speculums with sizes 2.5, 3.5 & 4.5 mm. Battery handle for 2 'C' batteries. Rheostat for adjustment of illumination. Supply in Black Pouch Packing



**Otoscope + Ophthalmoscope Set
01-115**

This otoscope is with 2.5 V standard illumination, handle is chrome plated as well otoscope head too. Handle and head is Lull / Faster lock fitting. Head of otoscope is with 6x magnifying glass. 03 Reusable speculums with sizes 2.5, 3.5 & 4.5 mm. A Full Functional Ophthalmoscope compact durable, light weight. Standard bulb and precision system. 4 different apertures selection range of lenses -20 to +20 bright white light and brilliant image. A Full Functional Ophthalmoscope Battery handle for 2 'C' batteries. Rheostat for adjustment of illumination. Supply in Black Pouch Packing.



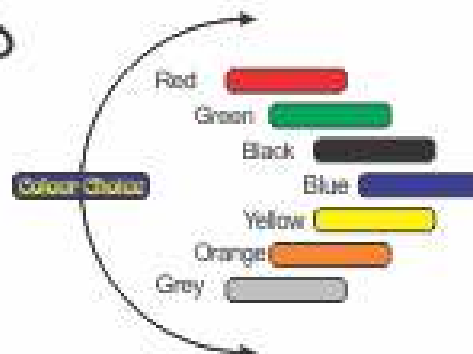
**Standard Ophthalmoscope
01-116**

A Full Functional Ophthalmoscope. compact durable, Standard bulb and precision system. 4 different apertures selection range of lenses -20 to +20 bright white light and brilliant image. Handle made of Stainless Steel Material.



**Mini Ophthalmoscope
01-117**

A Full Functional Ophthalmoscope. compact durable, light weight. Standard bulb and precision system. 4 different apertures selection range of lenses -20 to +20 bright white light and brilliant image. Made of plastic Material.

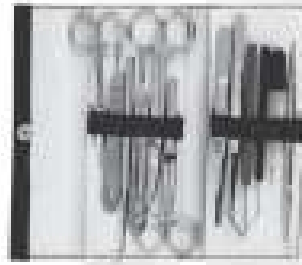


**Mini Ophthalmoscope
01-118**

A Full Functional Ophthalmoscope. compact durable, light weight. Standard bulb and precision system. 4 different apertures selection range of lenses -20 to +20 bright white light and brilliant image. made of plastic Material.



- 01-119**
Dissecting Set of 6 pcs.
- Dropper Oil
 - Probe Plastic Handle
 - Dressing Forceps
 - Dressing Scissors S/s
 - Hook
 - Scalpel Handle 4



- 01-120**
Dissecting Set of 12 pcs.
- Iris Scissors
 - Scalpel Knives 4
 - Probe Single Ended
 - Scalpel Handle 3
 - Dressing Scissors S/s
 - Dressing Scissors S/t
 - Dressing Forceps
 - College Tweezer
 - Probe Straight Plastic Handle
 - Probe Angular Plastic Handle
 - Dropper Oil
 - Hook



- 01-121**
New Instructor's Dissecting set
Contain quality stainless steel instrument Enclosed in an attractive zippered case. Scissor surgical 4 1/2" scissor fine point 4 1/2" Forceps fine point Str. Forcep fine point Cvd. Mosquito forceps Cvd 5" box lock. One piece scalpel 1 1/2" blade Surgeon handle # 4. Mail probe and seeker 2 plastic handle str needle also 2 blade # 22 for each set.



- 01-122**
Dissecting Set-Advanced
Stainless steel, consisting of 12 instruments for accurate dissection. Supplied in zipper leather case. Kit consists of:
Scissors - 2 pcs. Forceps - 2 pcs. Needle - 2 pcs.
Artery Forceps - 1 pc. Tissue Forceps - 1 pc.
Seeker - 1 pc. Scalpel Handle w/ Blade - 1 pc.
Bone Cutter - 1 pc. Dental Probe & Seeker - 1 pc.



- 01-123**
Dissecting Kit
Kit includes:
1 1/2" Dissecting forceps with curved and serrated tips
1 Curved dissecting needle 1 Glass pipette with rubber bulb
1 1/4" Dissecting forceps straight and serrated tips
1 Dissecting scalpel, 6" long, 1 1/2" cutting edge.
1 1/2" Dissecting scissors, sharp, straight points
1 Plastic ruler 6", 1/16" div., millimeter and centimeter



- 01-124**
Dissecting Set - Pro
Stainless steel, consisting of 20 instruments for accurate dissection. Supplied in zipper leather case. Kit consists of:
Scissors - 2 pcs. Forceps - 2 pcs. Needles - 4 pcs. Scalpel - 1 pc.
B.P. Handle w/ Blade - 1 pc. Razor - 1 pc. Ruler 6" - 1 pc.
Magnifying Glass - 1 pc. Glass Slide - 1 pc. Chain and Hook - 1 pc.
Cover Slides - 1 pc. Blow Pipe - 1 pc. Needle Wooden Handle - 1 pc.
Dropper Glass - 1 pc. Brush - 1 pc.



- 01-125**
Dissecting Set - Popular
Stainless steel, consisting of 14 instruments for accurate dissection. Complete in zipper leather case. Kit consists of:
Scissors - 2 pcs. Forceps - 2 pcs. Needles - 4 pcs. Scalpel - 1 pc.
B.P. Handle w/ Blade - 1 pc. Razor - 1 pc. Magnifying Glass - 1 pc.
Chain and Hook - 1 pc. Blow Pipe - 1 pc.



- 01-126**
Dissecting Set - Senior
Stainless steel, consisting of 9 instruments for accurate dissection. Supplied in zipper leather case. Kit consists of:
Scissors - 2 pcs. Forceps - 2 pcs. Needle - 2 pcs. Scalpel - 1 pc.
Scalpel Handle w/ Blade - 1 pc. Ruler 6" - 1 pc.

DISSECTING KITS

Diagnostik-bestecke
Estuches de diagnostico

Diagnostic Setts
Combinazioni per diagnostica



01-127
Dissecting Set



01-128
Dissecting Set



01-129
Dissecting Set



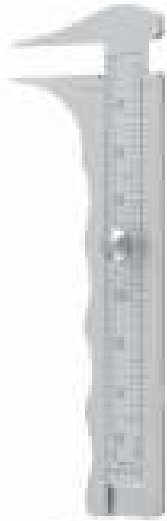
01-130
Dissecting Set



01-131
Dissecting Set



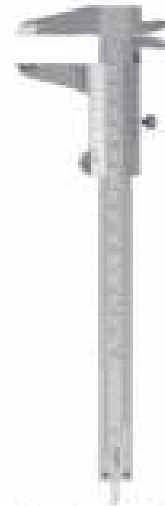
01-132
Dissecting Set



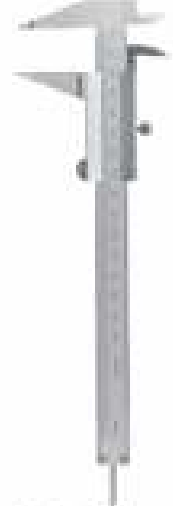
Jameson Caliper
01-133 8 cm



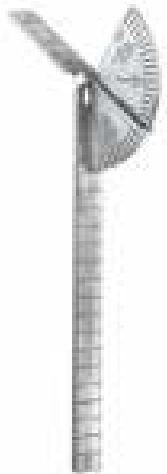
Townley Caliper
01-134 10 cm



Vernier Caliper
01-135 15 cm



Vernier Caliper
01-136 15 cm



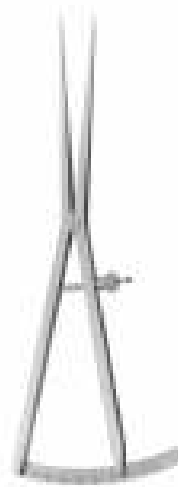
Carroll Pocket Goniometer
01-137 14.5cm



Möeltgen Flexometer
01-138 24cm



Bertillon Measuring Device
01-139 32 cm



Castroviejo-Epker Caliper
01-140 18 cm
Measuring range 40 mm, straight



Castroviejo-Epker Caliper
01-141 18 cm Angled
Measuring range 40 mm



Castroviejo Bone Caliper Straight
01-142 18cm



Castroviejo Bone Caliper Curved
01-143 18cm



Castroviejo-Epker Caliper
01-144 9 cm Str.
Measuring range, 40 mm
01-145 9 cm Cvd.
Measuring range, 40 mm



Castroviejo Eye View Caliper
01-146 8 cm, Str.
Measuring range, 20 mm
01-147 8 cm, Cvd.
Measuring range, 20 mm



Castroviejo Eye View Caliper
01-148 8 cm
Measuring range 20 mm



Tonometer Set
01-149



TROCARS, SUCTION TUBES, NEEDLE AND PROBES

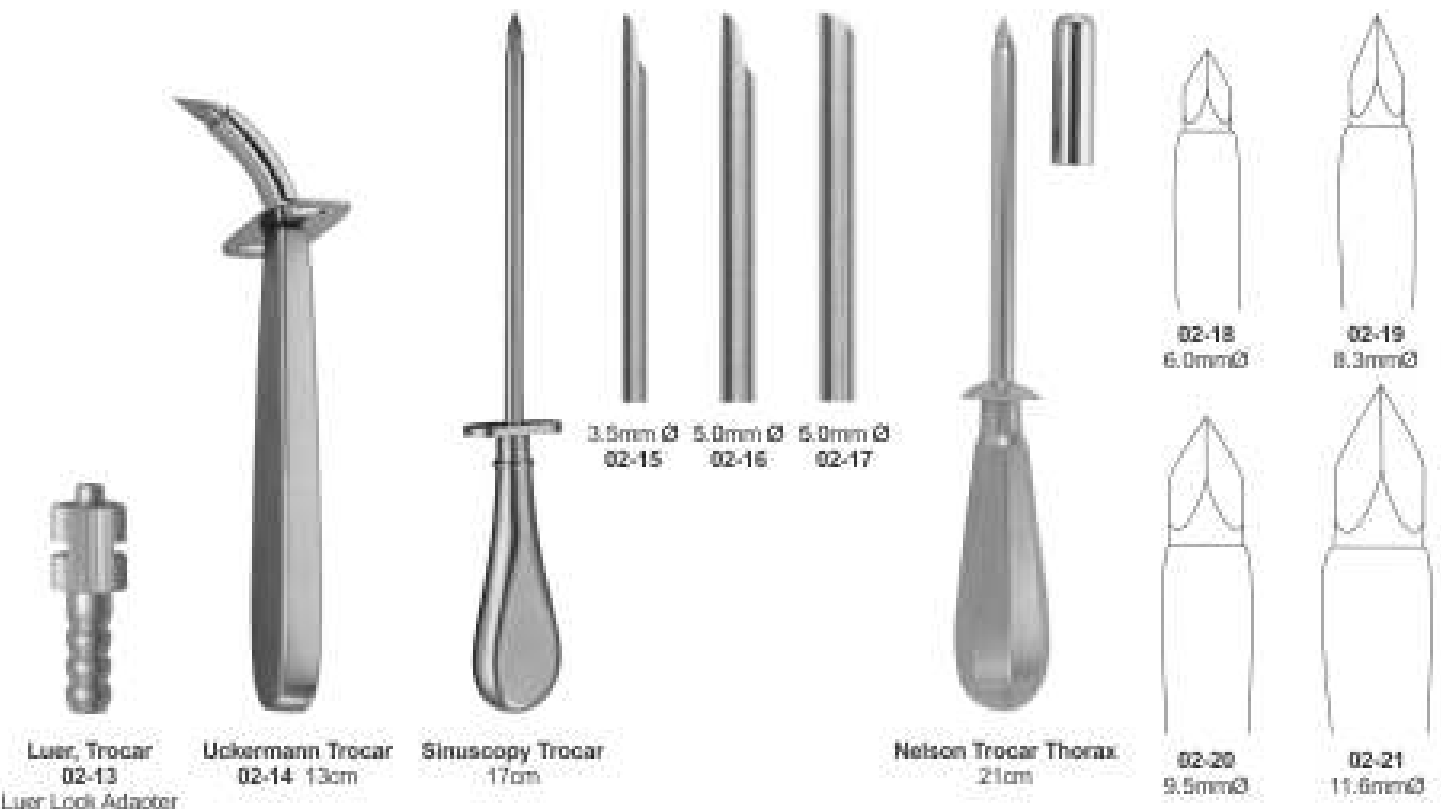




Universal Abdominal Trocar Set
02-01
(Handle with 4 needles) 14 cm
Fig. 1.7 mm Ø to 6 mm Ø
02-02
Only Handle

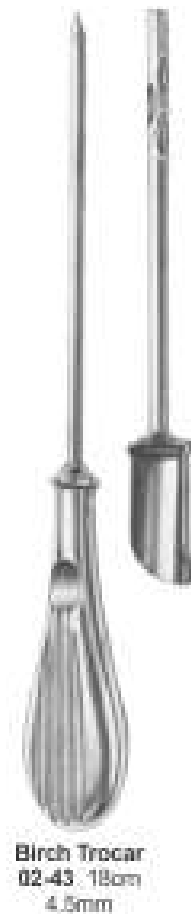
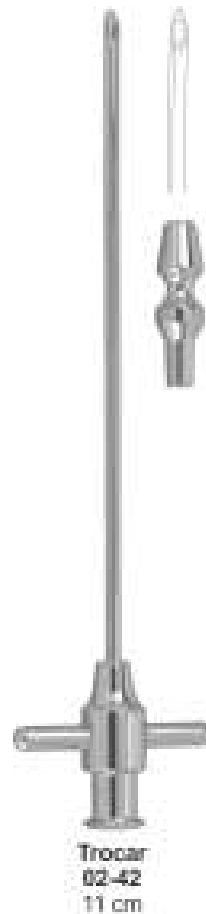
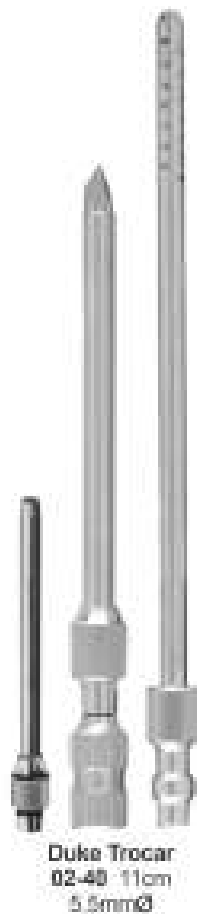
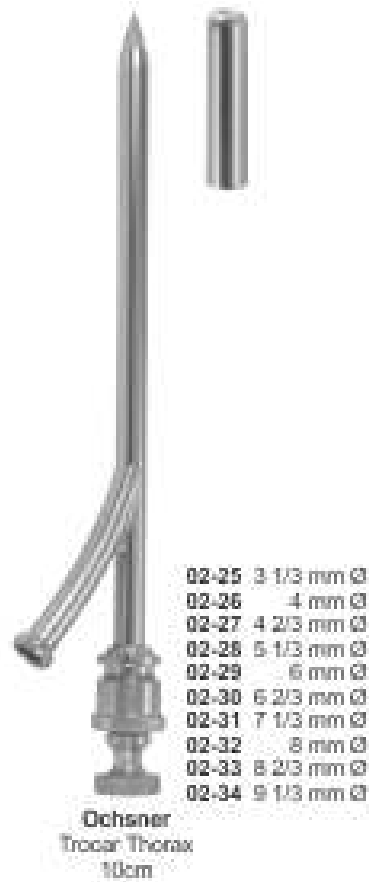


Universal Abdominal Trocar Set
02-07
(Handle with 4 needles) 14 cm
Fig. 1.7 mm Ø to 6 mm Ø
02-08
Only Handle



TROCARS

Trokare | Trócaros
Trocaris | Troquartí





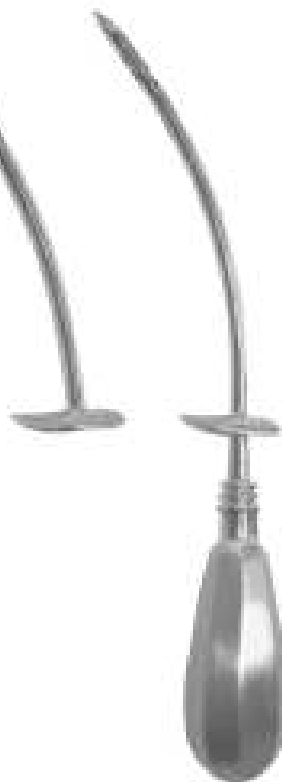
Buelau, Trocar
02-45 8 mm
24 cm



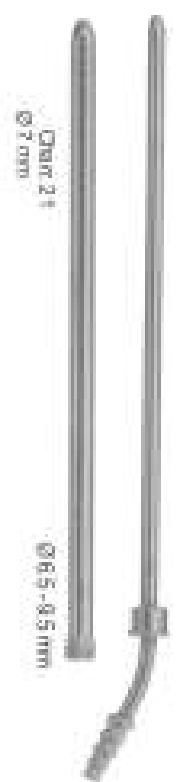
Flourant Trocar
02-46 23cm
5 mm Ø



Flourant Trocar
02-47 23cm
5mm Ø

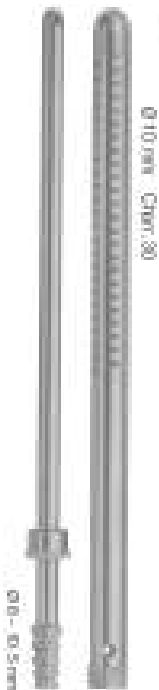


Flourant Trocar
02-48 23cm
5 mm Ø



Pool
02-49 22.5 cm
Suction cannula with
outer tube to be screwed

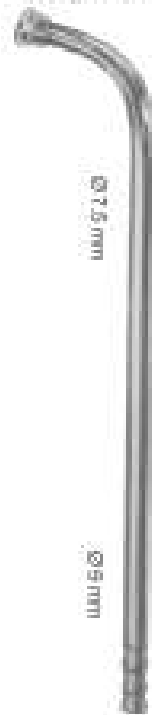
SUCTION TUBES



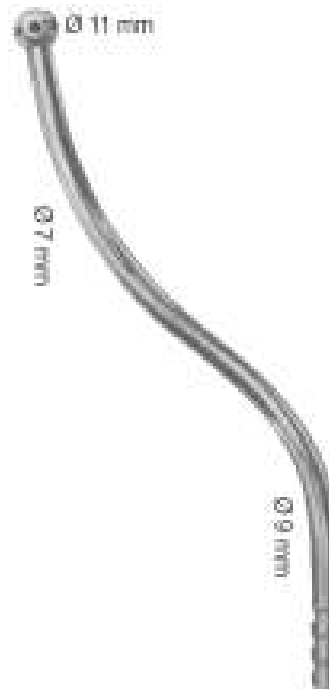
Pool
02-50 22.5 cm
Suction cannula with
outer tube to be screwed



02-51 18 cm
for tonsillectomy,
oral and laryngeal
operations



02-52 22 cm
Suction Cannula for
tonsillectomy, oral
and laryngeal operations



02-53 18 cm
suction cannula for
tonsillectomy, oral
and laryngeal operations



02-54 17 cm
S-shaped blunt cannula
for aspirating fluid from
the excretory ducts of
large glands and for
keeping the operations
area clear

SUCTION TUBES

Saugrohre

Tubos de aspiracion

Canules d'aspiration

Tubi per aspirazione



Coolley, Suction Tube
02-55 18 cm
6mm Ø



Coolley, Suction Tube
02-56 18 cm
7mm Ø



Coolley, Suction Tube
02-57 18 cm
Ø9mm



Coolley, Suction Tube
02-58 32.7 cm
8mm Ø Curved
Ø1.5mm



**Andrews-Pynchon
Suction Tube**
02-59 23.5 cm
Ø 2.1mm



**Yankauer
Suction Tube**
02-62
31 cm, 15 cm
2.5 cm, 10 cm



**Yankauer
Suction Tube**
02-63
31 cm, 15 cm
2.5 cm, 10 cm



**De Bakay
suction tube**
02-64
27.5 cm



Yankauer Suction Tube
02-65 27 cm
Baby Yankauer
02-66 21 cm



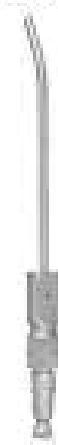
**Coupland
Suction Tube**
02-67



Byrd, Suction Tube
02-68 1.5 mm
02-69 2.5mm
02-70 3.5 mm



**Adson
suction tubes**
02-71
4 mm Ø
15 cm



**Adson
suction tubes**
21 cm
02-72
4 mm Ø 12 Char./Fr
02-73
5 mm Ø 15 Char./Fr



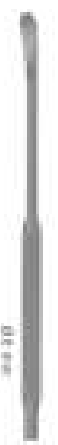
**02-74
Yulstein Suction
Tube Complete**



**Gorney
Suction Tubes**
02-75
18 cm
suction dissector



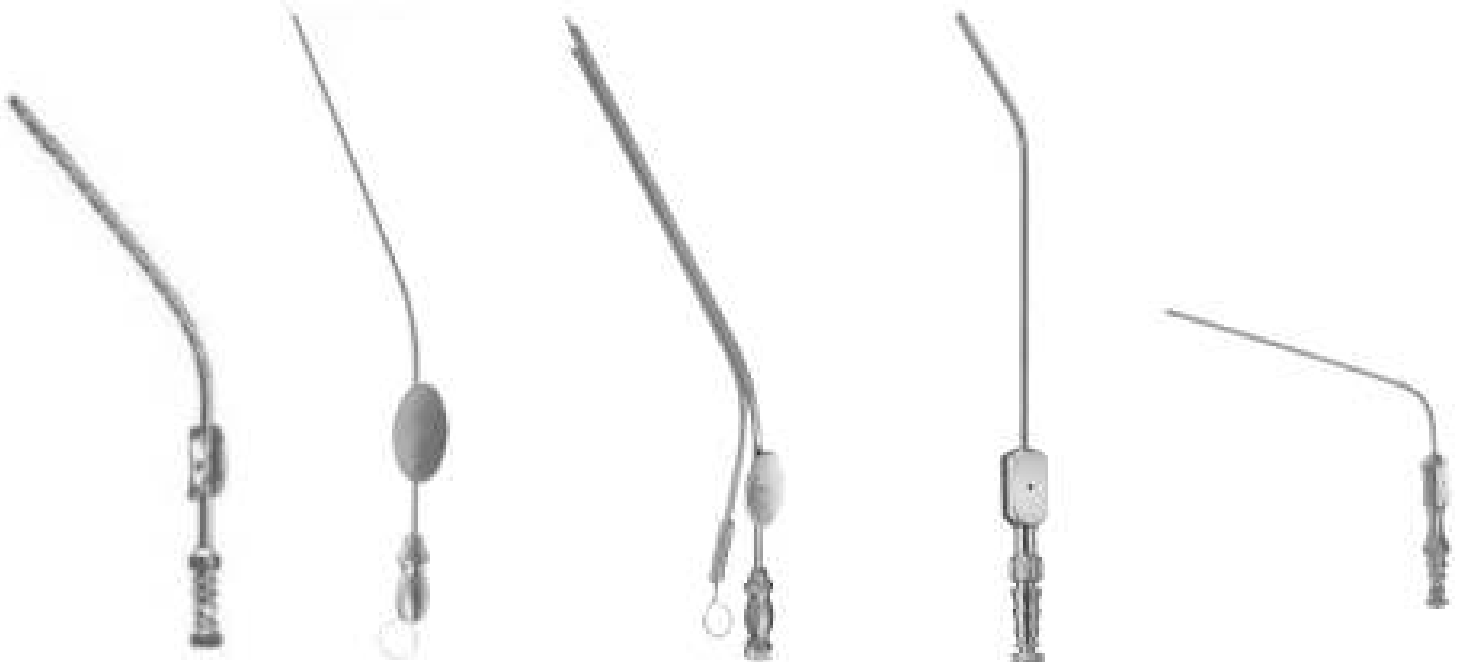
**Landolt Dissecting
Suction Tubes**
02-76 4 mm wide
02-77 5 mm wide
20 cm
suction raspatories, sharp,



**Lopez-Rainko
Suction Tubes**
02-78
23.5 cm
tonsil dissector with
suction device

SUCTION TUBES

Saugrohre | Tubos de aspiración
Canules d'aspiration | Tubi per aspirazione



Plester Daumenplatt
02-79 6 Char./Fr.
02-80 7 Char./Fr.
02-81 8 Char./Fr.
02-82 9 Char./Fr.
02-83 10 Char./Fr.
02-84 11 Char./Fr.
02-85 12 Char./Fr.
02-86 15 Char./Fr.

Basin suction tubes 7.5 cm
02-87 1 mm Ø 3 Char./Fr.
02-88 1.20 mm Ø 5 Char./Fr.
02-89 2.10 mm Ø 7 Char./Fr.

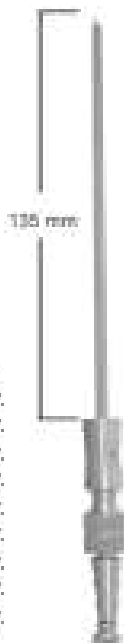
Basin suction tubes 10 cm
02-90 1 mm Ø 3 Char./Fr.
02-91 1.20 mm Ø 5 Char./Fr.
02-92 2.10 mm Ø 7 Char./Fr.

House suction tubes 7.5 cm
02-93 1 mm Ø 3 Char./Fr.
02-94 1.20 mm Ø 5 Char./Fr.
02-95 2.10 mm Ø 7 Char./Fr.
02-96 2.20 mm Ø 8 Char./Fr.
02-97 3.10 mm Ø 10 Char./Fr.
02-98 4 mm Ø 12 Char./Fr.
02-99 4.20 mm Ø 14 Char./Fr.

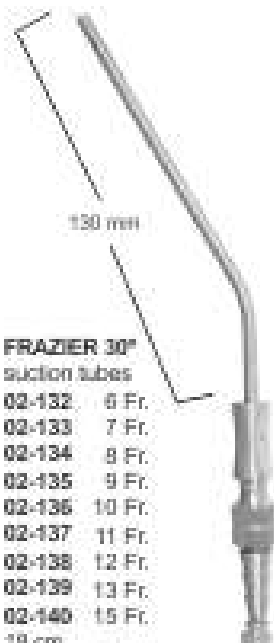
House suction tubes 10 cm
02-100 1 mm Ø 3 Char./Fr.
02-101 1.20 mm Ø 5 Char./Fr.
02-102 2.10 mm Ø 7 Char./Fr.
02-103 2.20 mm Ø 8 Char./Fr.
02-104 3.10 mm Ø 10 Char./Fr.
02-105 4 mm Ø 12 Char./Fr.
02-106 4.20 mm Ø 14 Char./Fr.

Plester Suction Tubes 17 cm
02-107 2.0 mm Ø 6 Char./Fr.
02-108 2.3 mm Ø 7 Char./Fr.
02-109 2.5 mm Ø 8 Char./Fr.
02-110 3.0 mm Ø 9 Char./Fr.
02-111 3.3 mm Ø 10 Char./Fr.
02-112 3.5 mm Ø 11 Char./Fr.
02-113 4.5 mm Ø 12 Char./Fr.
02-114 5.0 mm Ø 15 Char./Fr.

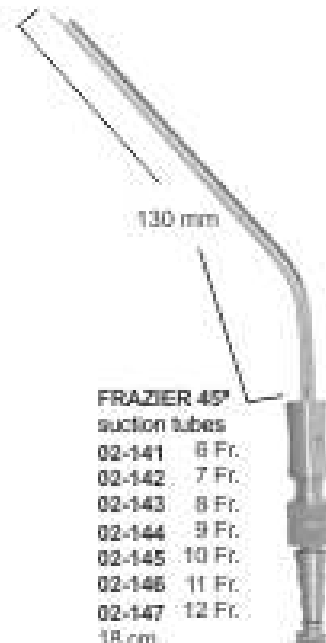
Ferguson Suction Tubes 17 cm
02-115 2.0 mm Ø 6 Char./Fr.
02-116 2.3 mm Ø 7 Char./Fr.
02-117 2.5 mm Ø 8 Char./Fr.
02-118 3.0 mm Ø 9 Char./Fr.
02-119 3.3 mm Ø 10 Char./Fr.
02-120 3.5 mm Ø 11 Char./Fr.
02-121 4.5 mm Ø 12 Char./Fr.
02-122 5.0 mm Ø 15 Char./Fr.



FRAZIER
suction tubes
02-123 6 Fr.
02-124 7 Fr.
02-125 8 Fr.
02-126 9 Fr.
02-127 10 Fr.
02-128 11 Fr.
02-129 12 Fr.
02-130 13 Fr.
02-131 15 Fr.
19 cm



FRAZIER 30°
suction tubes
02-132 6 Fr.
02-133 7 Fr.
02-134 8 Fr.
02-135 9 Fr.
02-136 10 Fr.
02-137 11 Fr.
02-138 12 Fr.
02-139 13 Fr.
02-140 15 Fr.
18 cm



FRAZIER 45°
suction tubes
02-141 6 Fr.
02-142 7 Fr.
02-143 8 Fr.
02-144 9 Fr.
02-145 10 Fr.
02-146 11 Fr.
02-147 12 Fr.
18 cm

Cannula

02-148 6fr
02-149 7fr
02-150 8fr
02-151 9fr
02-152 10fr
02-153 11fr
02-154 12fr
02-155 13fr
02-156 14fr



SUCTION AND IRRIGATION CANNULAS



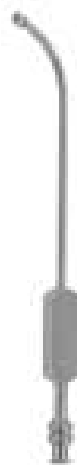
Saug- und Spülkanülen | Canulas para aspiración y lavado
 Canules pour aspiration | Cannule per aspirazione e lavaggio



Luer
02-157
 Suction Tube working
 length 110 mm



Nasal Suction Tubes
02-158 Ø 4,5 mm
02-159 Ø 5,5 mm
 17,5 cm



Eickon
Suction &
Irrigation Cannula
02-160 2,5 mm Ø
02-161 3,0 mm Ø
 Slightly curved



Eickon
Suction &
Irrigation Cannula
02-162 2,5 mm Ø
02-163 3,0 mm Ø
 Strongly curved



Tonsil Needle
Suction &
Irrigation Cannula
02-164 0,8 mm Ø
 Straight



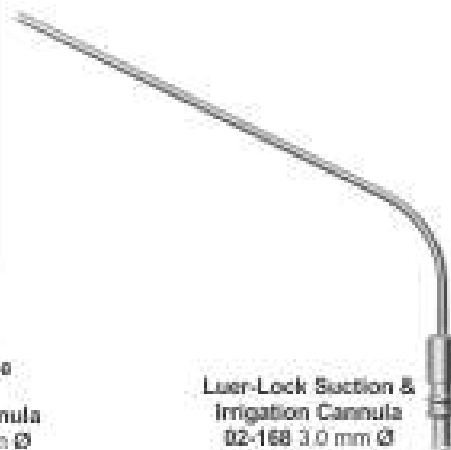
Tonsil Needle
Suction &
Irrigation Cannula
02-165 0,8 mm Ø
 Curved



Septum Needle
Suction &
Irrigation Cannula
02-166 0,8 mm Ø
 bayonet



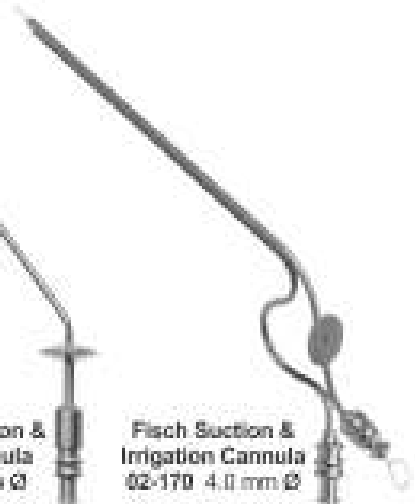
Septum Needle
Suction &
Irrigation Cannula
02-167 0,8 mm Ø
 angled on flat



Luer-Lock Suction &
Irrigation Cannula
02-168 3,0 mm Ø



Luer-Lock Suction &
Irrigation Cannula
02-169 2,5 mm Ø



Fisch Suction &
Irrigation Cannula
02-170 4,0 mm Ø

Probe, Double Ended

- 1,0 mm Ø
- 02-171** 11,5cm
- 02-172** 13,0cm
- 02-173** 14,5cm
- 02-174** 16,0cm
- 02-175** 18,0cm
- 02-176** 20,0cm
- 02-177** 25,0cm

Probe, Double Ended

- 1,5 mm Ø
- 02-178** 11,5cm
- 02-179** 13,0cm
- 02-180** 14,5cm
- 02-181** 16,0cm
- 02-182** 18,0cm
- 02-183** 20,0cm
- 02-184** 25,0cm

Probe, Double Ended

- 2,0 mm Ø
- 02-185** 11,5cm
- 02-186** 13,0cm
- 02-187** 14,5cm
- 02-188** 16,0cm
- 02-189** 18,0cm
- 02-190** 20,0cm
- 02-191** 25,0cm

Probe With Eye

- 2,0mm Ø
 - 02-192** 11,5cm
 - 02-193** 13,0cm
 - 02-194** 14,5cm
 - 02-195** 16,0cm
 - 02-196** 18,0cm
 - 02-197** 20,0cm
 - 02-198** 25,0cm
- with eyelet

Probe

- 2,0mm Ø
 - 02-199** 11,5cm
 - 02-200** 13,0cm
 - 02-201** 14,5cm
 - 02-202** 16,0cm
- myrtle-shaped

Ohrkatheter

Sondas auriculares

Sondes auriculaires

Sonde auriculari



Fig. 0
02-211

Fig. 1
02-212

Fig. 2
02-213

Fig. 3
02-214

Fig. 4
02-215

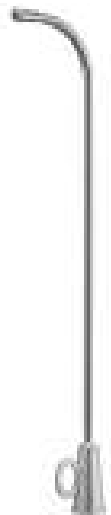
Fig. 5
02-216

Hartmann, Eustachian Catheters
Fig. 1
02-203 2.0 mm Ø
02-204 2.5 mm Ø
02-205 3.0 mm Ø

Hartmann Eustachian Catheters
Fig. 2
02-206 2.0 mm Ø
02-207 2.5 mm Ø
02-208 3.0 mm Ø

Killian, Eustachian Catheters
02-209 16 cm 2.5 mm Ø
02-210 16 cm 3.0 mm Ø oval opening

Hartmann Eustachian Catheters
15cm



02-217
Tube end piece for eustachian catheter

Fig. 2
02-219

Fig. 4
02-221

Fig. 1
02-218

Fig. 3
02-220

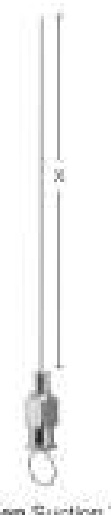
Fig. 5
02-222



Zöllner, Suction Tube
02-223 0.7mm Ø complete with 1 slip-on cannula, 0.7mm Ø



Iowa, Suction Tube
02-224 0.7mm Ø 16cm



Rosen Suction Tube
X=80 mm
02-225 0.7mm Ø
02-226 0.9mm Ø
02-227 1.2mm Ø

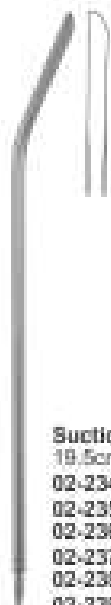


ROSEN, Suction Tube
X=65 mm
02-228 0.7mm Ø
02-229 0.9mm Ø
02-230 1.2mm Ø

Trötsch Eustachian Catheters 15cm



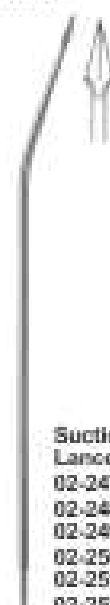
Magill Suction Tube
24.5cm
02-231 3.0mm Ø
02-232 3.5mm Ø
02-233 4.0mm Ø



Suction Tube, Guide Needle
19.5cm
02-234 2.2/3mmØ 8 Cham./Fr.
02-235 3.1/3mmØ 10 Cham./Fr.
02-236 4mmØ 12 Cham./Fr.
02-237 4.2/3mmØ 14 Cham./Fr.
02-238 5 1/3mmØ 16 Cham./Fr.
02-239 6mmØ 18 Cham./Fr.



Suction Tube, Guide Needle
19.5cm
02-240 2mmØ 6 Cham./Fr.
02-241 2.2/3mmØ 8 Cham./Fr.
02-242 3 1/3mmØ 10 Cham./Fr.
02-243 4mmØ 12 Cham./Fr.
02-244 4.2/3mmØ 14 Cham./Fr.
02-245 5 1/3mmØ 16 Cham./Fr.
02-246 6 1/3mmØ 18 Cham./Fr.



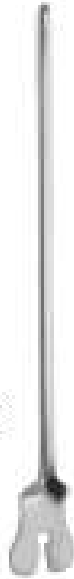
Suction Tube, Guide Needle Lancelot Tip 19.5cm
02-247 2.2/3mmØ 8 Cham./Fr.
02-248 3.1/3mmØ 10 Cham./Fr.
02-249 4mmØ 12 Cham./Fr.
02-250 4.2/3mmØ 14 Cham./Fr.
02-251 5 1/3mmØ 16 Cham./Fr.
02-252 6mmØ 18 Cham./Fr.

PROBES AND DIRECTORS

Sonden | Sondas y estiletes
Sondes et stylets | Specilli e sonde

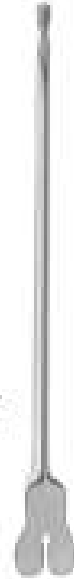
**Butterfly Grooved Director
With Tongue Tie Plain End**

- 02-253 11.5cm
- 02-254 13.0cm
- 02-255 14.5cm
- 02-256 16.0cm
- 02-257 18.0cm
- 02-258 20.0cm

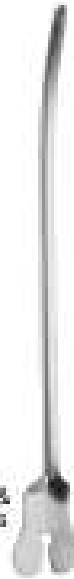


**Butterfly Grooved Director
With Tongue Tie Plain End**

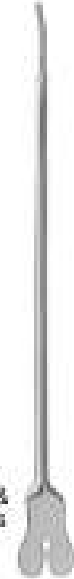
- 02-259 11.5cm
- 02-260 13.0cm
- 02-261 14.5cm
- 02-262 16.0cm
- 02-263 18.0cm
- 02-264 20.0cm



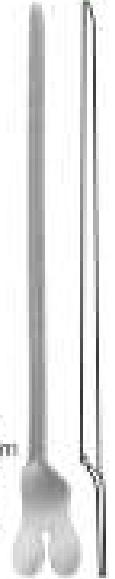
**Doyen
Probes &
Directors
02-265
14cm**



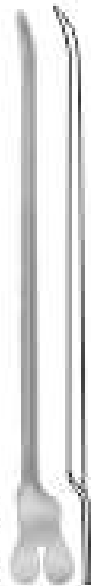
**Nelaton
Probes &
Directors
02-266
16cm**



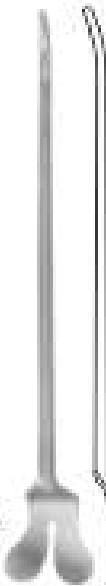
**Directors
02-267 13cm
02-268 14.5cm
02-269 16cm
Larry Probe
and Grooved
Director,
17.8 cm**



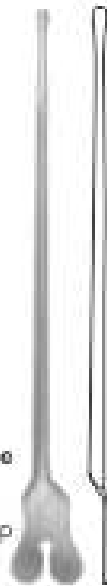
**Doyen
02-270
14.5cm**



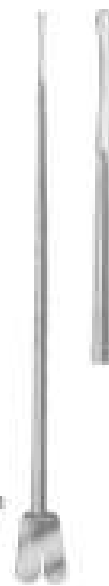
**Nelaton
02-271
16cm**



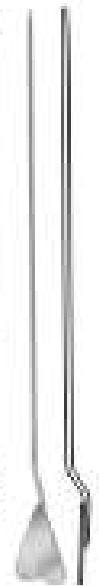
**Director Probe
End
02-272 14cm
Director with tip
Diam. of tip
3.3 mm**



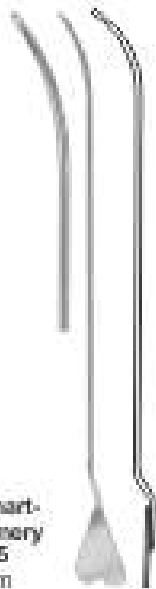
**Brodie
02-273 20cm
Director with
tip Diam. of
tip 3.5 mm**



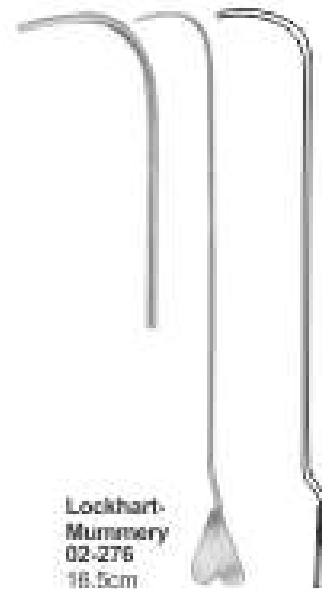
**Lockhart-
Mummary
02-274
16.5cm**



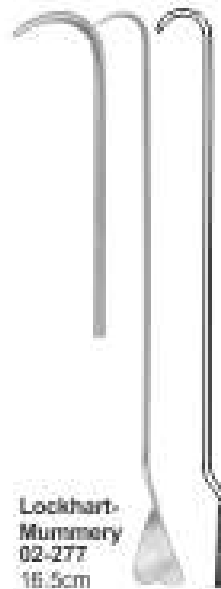
**Lockhart-
Mummary
02-275
16.5cm**



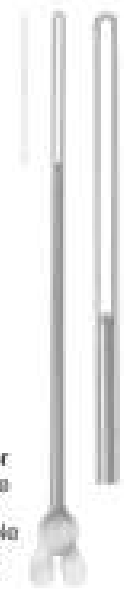
**Lockhart-
Mummary
02-276
16.5cm**



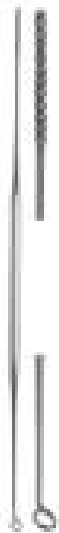
**Lockhart-
Mummary
02-277
16.5cm**



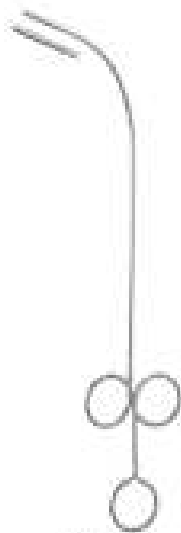
**Director
with wire
loop,
malleable
02-278
19cm**



COTTON APPLICATORS



**Jopson-Horne
Cotton Applicator**
02-279 18cm



**Fein Cotton
Applicator**
02-280 28cm



**Peterson Cotton
Applicator**
02-281 23cm



Barr Fistula Probe
02-282
with 20.3cm sterling shaft,
eye at tip, 29.2cm overall



Barr Crypt Hook
02-283
25.4cm short and
long hook ends



Bule Suction Tube
02-284
45 cm with finger
valve, 15 Fr. (5 mm)

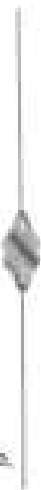
Bowman Lacrimal Probes Double Ended, Sterling Silver



**02-285
Bowman Probe,**
000-0000



**02-286
Bowman Probe,**
00-0



**02-287
Bowman Probe,**
1-2



**02-288
Bowman Probe,**
3-4



**02-289
Bowman Probe,**
5-6



**02-290
Bowman Probe,**
7-8

William Lacrimal Probes Double Ended, Sterling Silver



**02-291
William Probe,**
000-0000



**02-292
William Probe,**
00-0



**02-293
William Probe,**
1-2



**02-294
William Probe,**
3-4




**02-295
William Probe,**
5-6



**02-296
William Probe,**
7-8

Sonden | Sondas y estiletes
Sondas et stylets | Specilli e sonde

							
Bioivar 02-297 15cm 02-298 19cm 02-299 20cm	Desjardim 02-300 19cm (Set 3 Pieces)	Probes With Eye 02-301 14.5cm 02-302 16.0cm 02-303 20.0cm	Myrtle Leaf Probe 02-304 14.5cm	Myrtle Leaf Probe 02-305 13.0cm 02-306 14.5cm 02-307 16.0cm 02-308 18.5cm 02-309 20.0cm	Probe 02-310	Wilder Lacrimal Dilator 02-311 10cm medium taper	02-312 19cm Double ended probe, malleable, diam. of tips 3 mm with hole
							
02-313 25cm 02-314 30cm Double ended probes, tin, malleable, diam. of tips 3.5 mm with hole	02-315 40cm Double ended probes, tin, malleable, diam. of tips 4 mm with hole	02-316 1.5 mm 02-317 2.0 mm 02-318 2.5 mm 30cm	Clips Mayo 02-319 14cm	Stacke 02-320 10cm	Killian 02-321 15.5cm	02-322 16.5cm	Seiffert 02-323 18cm
							
Modell Piccolo 02-324 11cm Round Serrated	Modell Piccolo 02-325 11cm Triangular Serrated and	Farrell 02-326 11cm Round Serrated end	Lathbury-Farrel 02-327 11cm Triangular Serrated end	Spatula 02-328 14.5cm	Spatula 02-329 14.5cm		

SCALPEL HANDLE, SCALPEL BLADES, DISSECTING KNIVES & SAWS



SCALPEL HANDLES

Skalpelli-griffe

Mangos de bisturios

Manches pour bistouris

Manici per bisturi



03-01

#3 Scalpel Handle
12.50 cm
Blade Size 10, 11,
12, 13, 15, 17



03-02

#3 Scalpel Handle/
Graduated 12.75 cm
Blade Size 10, 11,
12, 13, 15, 17



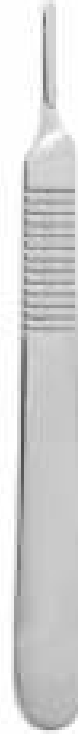
03-03

Scalpel Handle
#4 Graduated
with scale



03-04

#4 Scalpel Handle
12.75 cm Blade
Size 18, 20, 21, 22,
23, 24, 25, 60,70



03-05

#4 Scalpel Handle/
Graduated 12.75 cm
Blade Size 18, 20, 21,
22, 23, 24, 25, 60,70



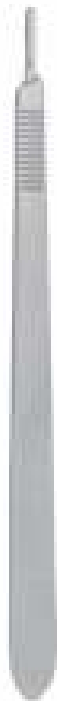
03-06

4LA Scalpel Handle
21 cm Blade
Size 18, 20, 21, 22,
23, 24, 25, 60,70



03-07

#3, #4 Scalpel
Handle
Double Ended
16 cm



03-08

Scalpel Handle
3L Long 21 cm
Blade Size
10, 11, 12, 15, 17



03-09

#7 Scalpel
Handle
16.5 cm
Blade 10, 11,
12, 13, 15, 17



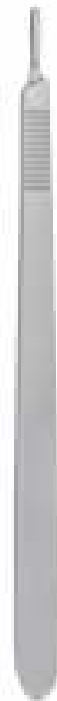
03-10

Fig. 10 - 17
12.5cm
Solid



03-11

Scalpel Handle
4L Long 21 cm
Blade
Size 18, 20, 21,
22, 23, 24, 25,
60,70



03-12

#3LA Scalpel
Handle / Long
Angled 20.25 cm
Blade Size
10, 11, 12, 15, 17



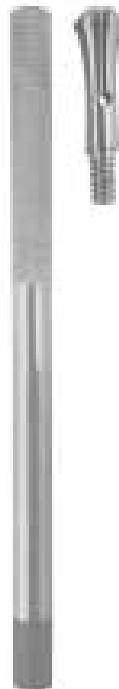
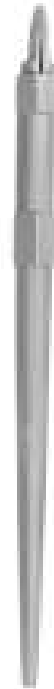
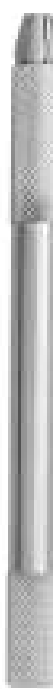
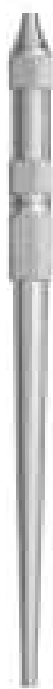
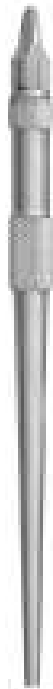
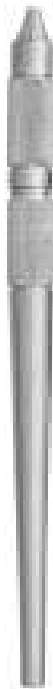
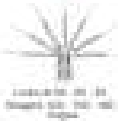
03-13

Knife Handle
(Smooth)
for
Blades Nos.
60 and 70

SCALPEL HANDLES

Skalpelgriffe
Mangos de bisturias

Manches pour bistouris
Manici per bisturi



03-14
Siegel Round
Scalpel Handle
#3 With Adjustable
Tip 16 cm
Blade Size 10,
11, 12, 13, 15,
17

03-15
Siegel Round
Scalpel Handle
#4 With Adjustable
Tip 16 cm
Blade Size 18, 20,
21, 22, 23, 24,
25, 60, 70

03-16
Round Knurled
Scalpel Handle
11.5 cm
Blade Size
50, 60 & 70

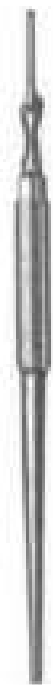
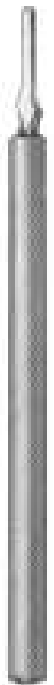
03-17
Round Knurled
Scalpel Handle
12.7 cm
Blade Size
50, 60 & 70

03-18
Round Knurled
Scalpel Handle
12.7 cm
Blade Size
50, 60 & 70

03-19
Round Knurled
Scalpel Handle
11 cm
Blade Size
50, 60 & 70

03-20
Round Knurled
Scalpel Handle
13.5 cm
Blade Size
50, 60 & 70

03-21
Beaver
Handle



03-22
Round Knurled
Scalpel Handle
12 cm

03-23
#3RK Kaye
Round Scalpel
Handle 15 cm,
Blade
Size 10, 11,
12, 13, 15, 17

03-24
#3R Corwin
Round Scalpel
Handle
14.5 cm
Blade Size 10,
11, 12, 15, 17

03-25
#4R Corwin Round
Scalpel Handle,
14.5 cm
Blade Size 18, 20,
21, 22, 23, 24,
25, 60, 70

03-26
#3RC Scalpel
Handle 14 cm,
Blade
Size 10, 11, 12,
13, 15, 17

03-27
#3P Scalpel
Handle 15.5 cm,
Blade Size
10, 11, 12, 13,
15, 17

03-28
15.5cm
Blade Size
10 - 17
With Round
Hollow Handle

03-29
Scalpel
Handle

03-30
Scalpel Grip

SCALPEL HANDLES, BLADE BREAKERS

Skalpgriffe, Klängenbrecher

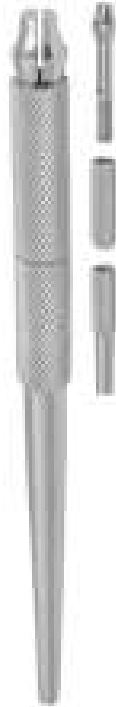
Mangos de bisturí, rompe cuchillas

Poignées de scalpel, disjoncteurs de lame

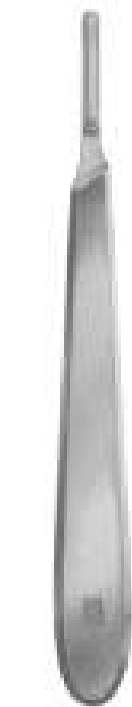
Manici per bisturí, rompitrama



03-31
Round Scalpel Handle,
Double Head #3,
Blade Size 10, 11, 12,
13, 15, 17



Bever Handle 03-32



03-33
Scalpel Plastic Handle #8 Blade
Size 18, 20, 21,
22, 23, 24, 25,
60,70



03-34
Collin Scalpel Handle #9 Blade
Size 10, 11, 12,
13, 15, 17



Fig. 10



Fig. 11

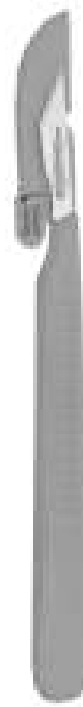
Blade Sizes



Fig. 12



Fig. 15



03-35
Scalpel Plastic Handle



03-36
Scalpel Plastic Handle #5
Blade Size 10, 11, 12,
13, 15, 17



03-37
Scalpel Plastic Handle #6
Blade Size 18,
20, 21, 22, 23,
24, 25, 60,70

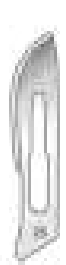


Fig. 20

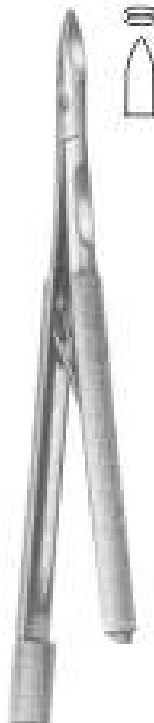


Fig. 22

RAZOR BLADE HOLDER & BREAKERS



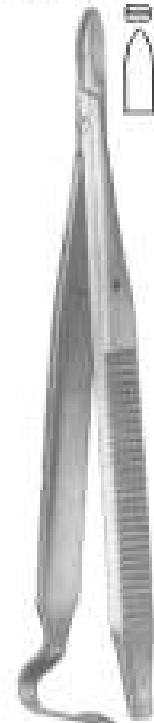
03-38
Cole-Parmer Dissecting
Blade Remover For
Blade Handle



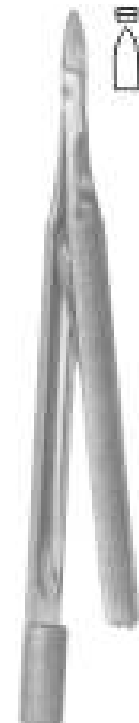
03-39
Troutman-Chris
Blade Breaker &
Holder with Push-
Pull Lock 9 cm



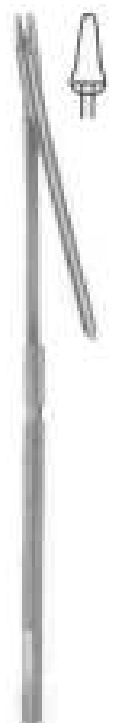
03-40
Troutman-Chris
Blade Breaker &
Holder angled, with
Push-Pull Lock
9 cm



03-41
Blade Holder Blade
Breaker & Holder,
with Ratchet Lock
11 cm



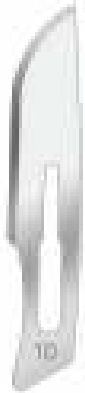
03-42
Castroviejo Blade
Breaker & Holder,
with Push-Pull Lock
13 cm



03-43
Razor Blade
Breaker & Holder,
Straight
18.5 cm



03-44
Sterile Scalpel
Blade Size # 6
Stainless Steel



03-45
Sterile Scalpel
Blade Size # 10
Stainless Steel



03-46
Sterile Scalpel
Blade Size # 10A
Stainless Steel



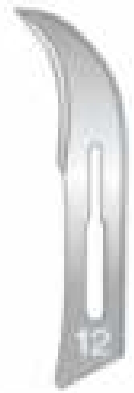
03-47
Sterile Scalpel
Blade Size # 11
Stainless Steel



03-48
Sterile Scalpel
Blade Size # 11P
Stainless Steel



03-49
Sterile Scalpel
Blade Size # E 11
Stainless Steel



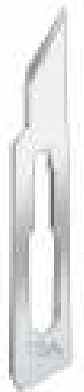
03-50
Sterile Scalpel
Blade Size # 12
Stainless Steel



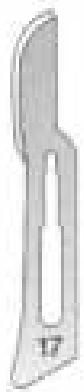
03-51
Sterile Scalpel
Blade Size # 13
Stainless Steel



03-52
Sterile Scalpel
Blade Size # 15
Stainless Steel



03-53
Sterile Scalpel
Blade Size # 15A
Stainless Steel



03-54
Sterile Scalpel
Blade Size # 17
Stainless Steel



03-55
Sterile Scalpel
Blade Size # 18
Stainless Steel



03-56
Sterile Scalpel
Blade Size # 20
Stainless Steel



03-57
Sterile Scalpel
Blade Size # 21
Stainless Steel



03-58
Sterile Scalpel
Blade Size # 22
Stainless Steel



03-59
Sterile Scalpel
Blade Size # 23
Stainless Steel



03-60
Sterile Scalpel
Blade Size # 24
Stainless Steel



03-61
Sterile Scalpel
Blade Size # 25
Stainless Steel



03-62
Sterile Scalpel
Blade Size # 36
Stainless Steel



03-63
Sterile Scalpel
Blade Size # 40
Stainless Steel



03-64
Sterile Scalpel
Blade Size # 60
Stainless Steel

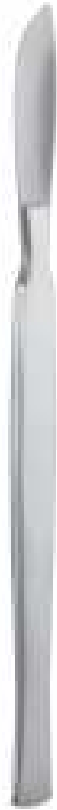


03-65
Sterile Scalpel
Blade Size # 70
Stainless Steel

SCALPEL KNIVES

Operations-Scalpelle
Bistouris pour operations

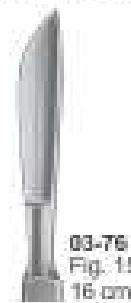
Bisturios para operaciones
Bisturi per operazioni



DIEFFENBACH
16 cm



03-66 Fig. 1 16 cm
03-67 Fig. 2 16 cm
03-68 Fig. 3 16 cm
03-69 Fig. 4 16 cm
03-70 Fig. 5 16 cm
03-71 Fig. 6 16 cm
03-72 Fig. 7 16 cm
03-73 Fig. 8 16 cm
03-74 Fig. 9 16 cm
03-75 Fig. 10 16 cm



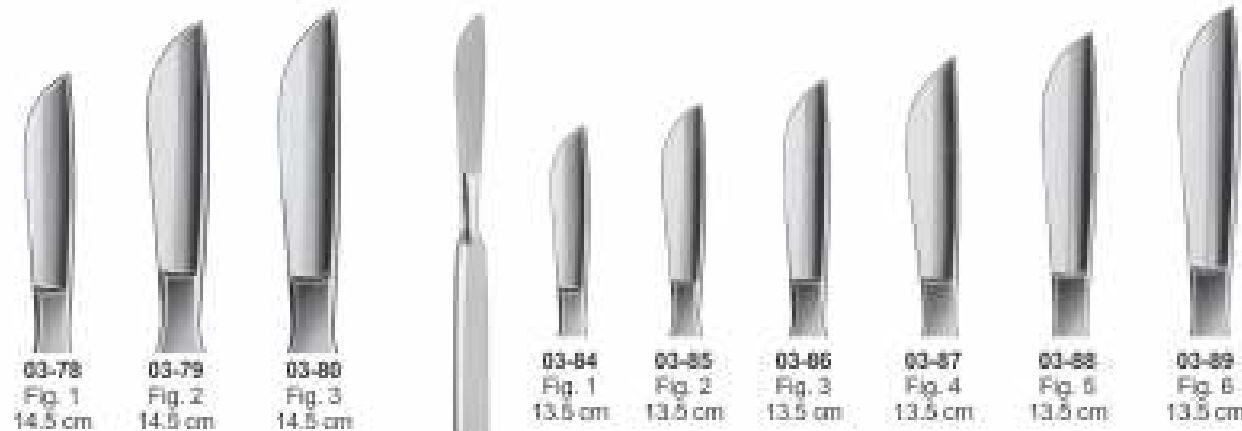
03-76
Fig. 15
16 cm



03-77
Fig. 16
16 cm



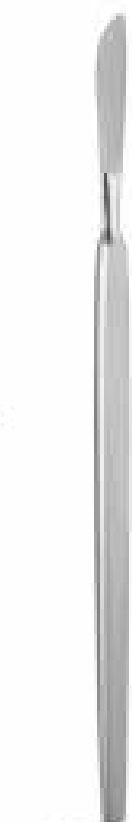
Collin Dissecting Knives
14.5 cm



03-78 Fig. 1 14.5 cm
03-79 Fig. 2 14.5 cm
03-80 Fig. 3 14.5 cm
03-84 Fig. 1 13.5 cm
03-85 Fig. 2 13.5 cm
03-86 Fig. 3 13.5 cm
03-87 Fig. 4 13.5 cm
03-88 Fig. 5 13.5 cm
03-89 Fig. 6 13.5 cm



03-81 Fig. 4 14.5 cm
03-82 Fig. 5 14.5 cm
03-83 Fig. 6 14.5 cm



Dieffenbach Dissecting Knives
13.5 cm



03-90 Fig. 7 13.5 cm
03-91 Fig. 8 13.5 cm
03-92 Fig. 9 13.5 cm
03-93 Fig. 10 13.5 cm

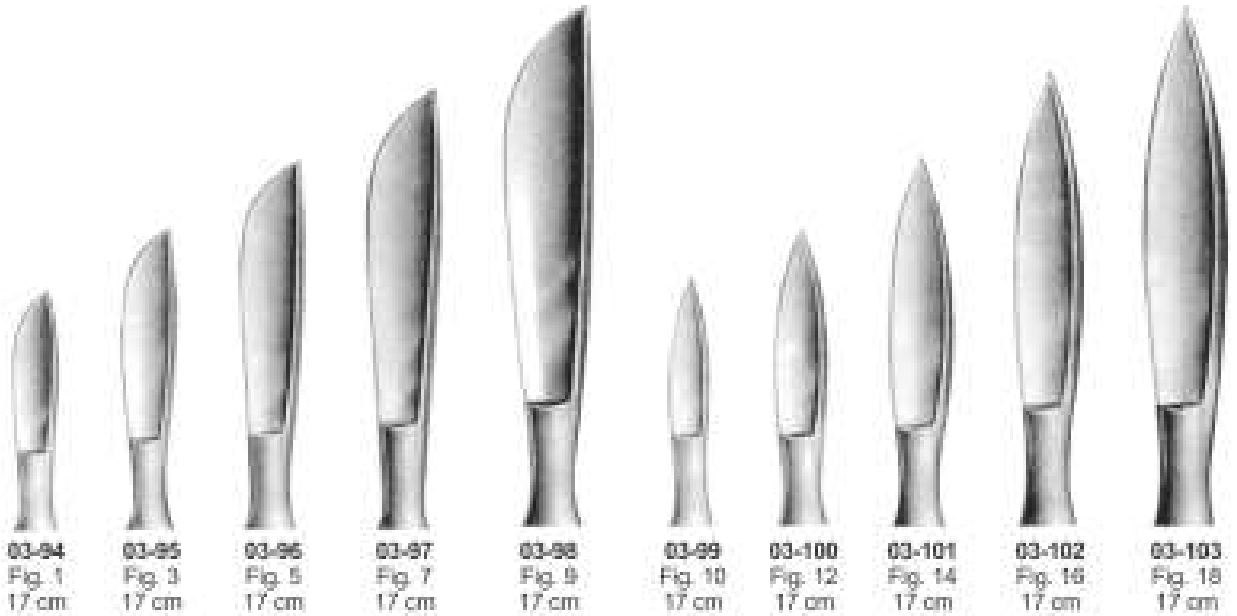
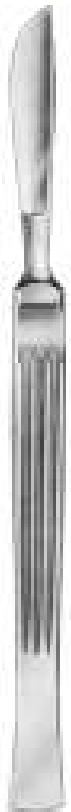
SCALPEL KNIVES

Operations-Scalpelle

Bisturries para operaciones

Bistouris pour operations

Bisturi per operazioni



03-94
Fig. 1
17 cm

03-95
Fig. 3
17 cm

03-96
Fig. 5
17 cm

03-97
Fig. 7
17 cm

03-98
Fig. 9
17 cm

03-99
Fig. 10
17 cm

03-100
Fig. 12
17 cm

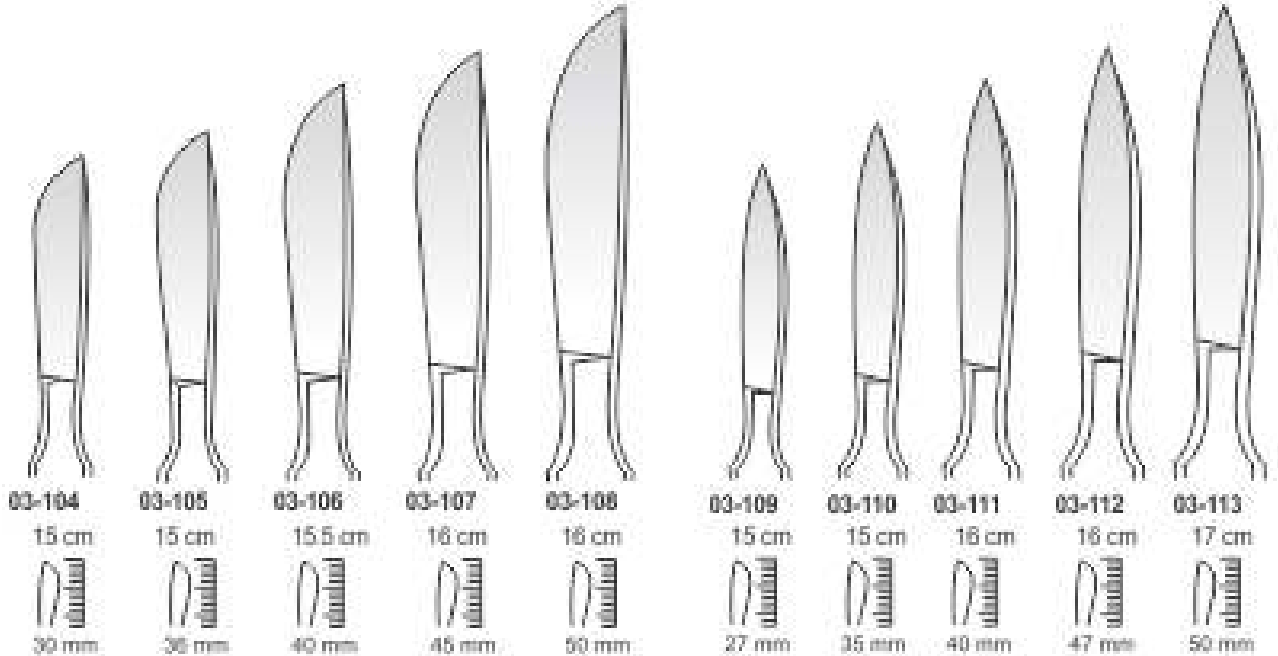
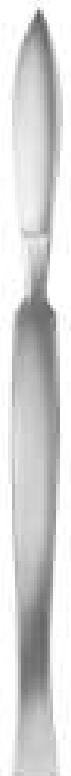
03-101
Fig. 14
17 cm

03-102
Fig. 16
17 cm

03-103
Fig. 18
17 cm

Dissecting Knives
17 cm

DISSECTING KNIVES



03-104
15 cm
30 mm

03-105
15 cm
35 mm

03-106
15.5 cm
40 mm

03-107
16 cm
45 mm

03-108
16 cm
50 mm

03-109
15 cm
27 mm

03-110
15 cm
35 mm

03-111
16 cm
40 mm

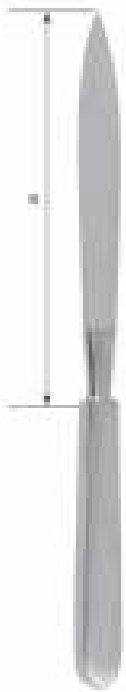
03-112
16 cm
47 mm

03-113
17 cm
50 mm

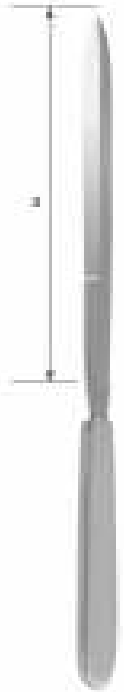
DISSECTING KNIFE
15 cm
with metal handle

Anatomische skalpelle
Bisturios para disección

Bistouris à dissection
Bisturi para dissezione



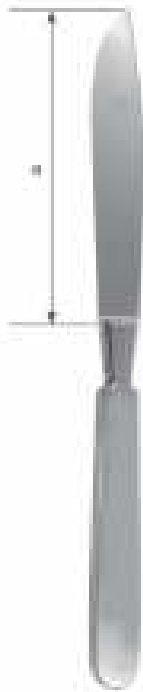
Collin Dissecting Knives Blade Size
03-114 13 cm
03-115 16 cm
03-116 19 cm
03-117 22 cm
03-118 28 cm



Collin Dissecting Knives Blade Size
03-119 16 cm
03-120 19 cm
03-121 22 cm



Liston Dissecting Knives Blade Size
03-122 16 cm
03-123 19 cm
03-124 22 cm



Langenbeck Dissecting Knives Blade
03-125 12 cm



Amputation Knife
03-126 29 cm



Amputation Knife
03-127 32.5 cm



Collin Amputation Knife
03-128 29 cm



Resection Knife
03-129 18 cm



Langenbeck Amputation Knife
03-130 18 cm



Langenbeck Amputation Knife
03-131 18 cm



Dieffenbach Dissecting Knives
03-132 13 cm



Dieffenbach Dissecting Knives
03-133 13 cm



Simon Dissecting Knives
23.5 cm



03-134 Fig. 1



03-135 Fig. 2



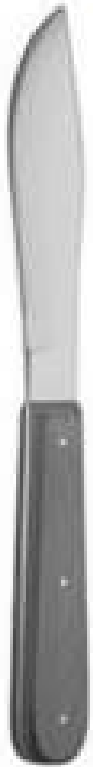
03-136 Fig. 3



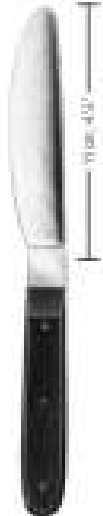
03-137 Fig. 4

DISSECTING KNIVES

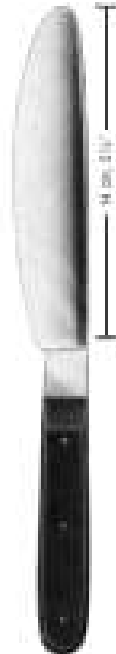
Anatomische skalpelle | Bistouris à dissection
 Bisturiles para disección | Bisturi para dissezione



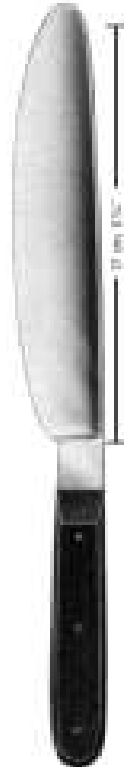
Autopsy Knife
03-138
25.5 cm



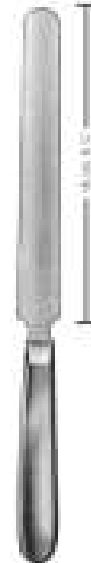
Walsh Dissecting Knives
03-139
11 cm



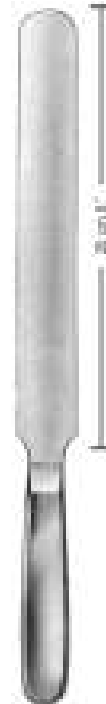
Walsh Dissecting Knives
03-140
14 cm



Walsh Dissecting Knives
03-141
17 cm



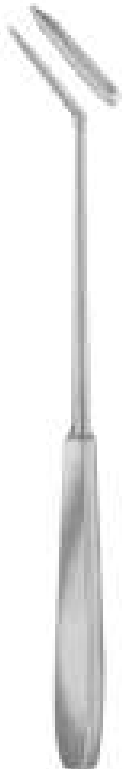
Virchow Dissecting Knives
03-142
16 cm



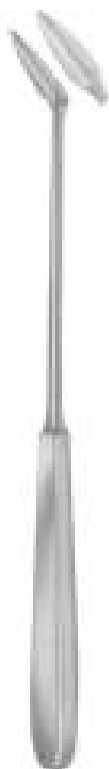
Virchow Dissecting Knives
03-143
20 cm



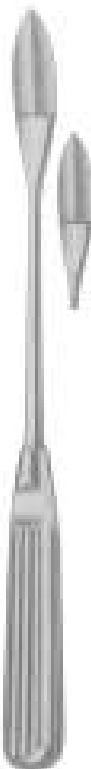
Virchow Dissecting Knives
03-144
24 cm



Ayre Cone Knife
03-145
23.5 cm



Cone Knife
03-146
23 cm



Sogond Myomatome
03-147
27 cm



Olivocrona Trigeminal knife
03-148
20.5 cm



Trigeminal knife
03-149
23 cm



Fowler Tonsil Knife
03-150
20 cm



Abraham Tonsil Knife
03-151
21.5 cm

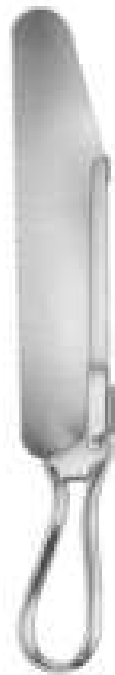
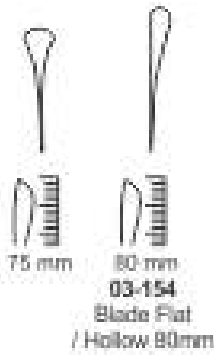


Brunings Tonsil knife
03-152
21.5 cm

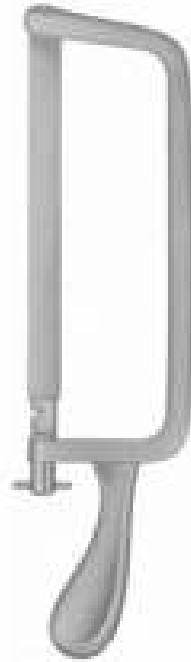
AMPUTATION KNIVES & RESECTION SAWS



RAZOR HOLLOW
Blades On
Both Sides
Blade Flat / Hollow
03-153



**Chamiere Amputation
& Resection**
03-155 - 27cm
03-156 - 30cm



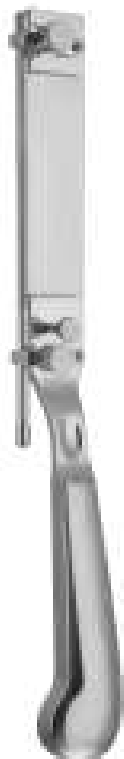
**Chamiere Amputation
& Resection**
03-157 - 35cm



**Satterlee Amputation
& Resection**
03-158 - 31cm



Thiersch
03-159
20 cm



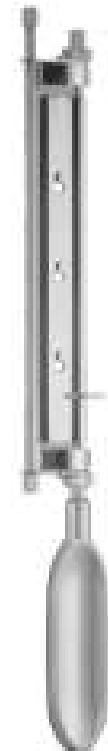
Schink
03-160 - 30cm
Complete with 1
Blade & 2 plates



03-161
Spare Blade



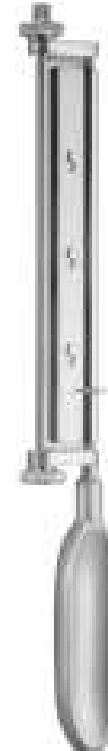
03-162
Skin fixing plate



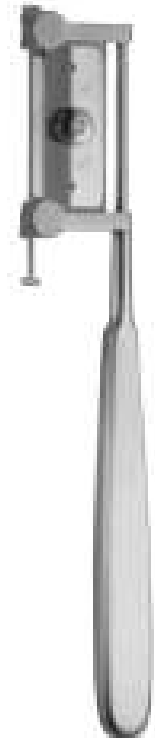
Hunby Dermatomes
03-163 - 31cm
Complete with 1 Blade



03-164
spare blade



Watson Dermatomes
03-165 - 30cm
Complete with 1 Blade,
fixed bar

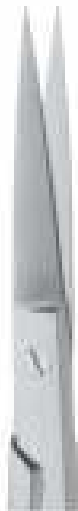


Silver Dermatomes
03-166 - 19cm

GENERAL OPERATING SCISSORS



Operating Scissors (Flat Pattern)



Operating Scissors

04-001	11.5 cm	S/S Str.
04-002	12.5 cm	S/S Str.
04-003	13 cm	S/S Str.
04-004	14.5 cm	S/S Str.
04-005	16 cm	S/S Str.
04-006	18 cm	S/S Str.
04-007	20 cm	S/S Str.
04-008	23 cm	S/S Str.
04-009	25 cm	S/S Str.
04-010	28 cm	S/S Str.
04-011	30 cm	S/S Str.



Operating Scissors

04-012	11.5 cm	S/S Cvd
04-013	12.5 cm	S/S Cvd
04-014	13cm	S/S Cvd
04-015	14.5 cm	S/S Cvd
04-016	16 cm	S/S Cvd
04-017	18 cm	S/S Cvd
04-018	20 cm	S/S Cvd
04-019	23 cm	S/S Cvd
04-020	25 cm	S/S Cvd
04-021	28 cm	S/S Cvd
04-022	30 cm	S/S Cvd



Operating Scissors

04-023	11.5 cm	B/B Str.
04-024	12.5 cm	B/B Str.
04-025	13 cm	B/B Str.
04-026	14.5 cm	B/B Str.
04-027	16 cm	B/B Str.
04-028	18 cm	B/B Str.
04-029	20 cm	B/B Str.
04-030	23 cm	B/B Str.
04-031	25 cm	B/B Str.
04-032	28 cm	B/B Str.
04-033	30 cm	B/B Str.



Operating Scissors

04-034	11.5 cm	B/B Cvd
04-035	12.5 cm	B/B Cvd
04-036	13 cm	B/B Cvd
04-037	14.5 cm	B/B Cvd
04-038	16 cm	B/B Cvd
04-039	18 cm	B/B Cvd
04-040	20 cm	B/B Cvd
04-041	23 cm	B/B Cvd
04-042	25 cm	B/B Cvd
04-043	28 cm	B/B Cvd
04-044	30 cm	B/B Cvd



Operating Scissors

04-045	11.5 cm	S/B Str.
04-046	12.5 cm	S/B Str.
04-047	13 cm	S/B Str.
04-048	14.5 cm	S/B Str.
04-049	16 cm	S/B Str.
04-050	18 cm	S/B Str.
04-051	20 cm	S/B Str.
04-052	23 cm	S/B Str.
04-053	25 cm	S/B Str.
04-054	28 cm	S/B Str.
04-055	30 cm	S/B Str.



Operating Scissors

04-056	11.5 cm	S/B Cvd
04-057	12.5 cm	S/B Cvd
04-058	13 cm	S/B Cvd
04-059	14.5 cm	S/B Cvd
04-060	16 cm	S/B Cvd
04-061	18 cm	S/B Cvd
04-062	20 cm	S/B Cvd
04-063	23 cm	S/B Cvd
04-064	25 cm	S/B Cvd
04-065	28 cm	S/B Cvd
04-066	30 cm	S/B Cvd



Operating Scissors

04-067	11.5 cm	S/S Str.
04-068	12.5 cm	S/S Str.
04-069	13 cm	S/S Str.
04-070	14.5 cm	S/S Str.
04-071	16 cm	S/S Str.
04-072	18 cm	S/S Str.
04-073	20 cm	S/S Str.
04-074	23 cm	S/S Str.
04-075	25 cm	S/S Str.
04-076	28 cm	S/S Str.
04-077	30 cm	S/S Str.



Operating Scissors

04-078	11.5 cm	S/S Cvd
04-079	12.5 cm	S/S Cvd
04-080	13 cm	S/S Cvd
04-081	14.5 cm	S/S Cvd
04-082	16 cm	S/S Cvd
04-083	18 cm	S/S Cvd
04-084	20 cm	S/S Cvd
04-085	23 cm	S/S Cvd
04-086	25 cm	S/S Cvd
04-087	28 cm	S/S Cvd
04-088	30 cm	S/S Cvd



Operating Scissors

04-089	11.5 cm	B/B Str.
04-090	12.5 cm	B/B Str.
04-091	13 cm	B/B Str.
04-092	14.5 cm	B/B Str.
04-093	16 cm	B/B Str.
04-094	18 cm	B/B Str.
04-095	20 cm	B/B Str.
04-096	23 cm	B/B Str.
04-097	25 cm	B/B Str.
04-098	28 cm	B/B Str.
04-099	30 cm	B/B Str.



Operating Scissors

04-100	11.5 cm	B/B Cvd
04-101	12.5 cm	B/B Cvd
04-102	13 cm	B/B Cvd
04-103	14.5 cm	B/B Cvd
04-104	16 cm	B/B Cvd
04-105	18 cm	B/B Cvd
04-106	20 cm	B/B Cvd
04-107	23 cm	B/B Cvd
04-108	25 cm	B/B Cvd
04-109	28 cm	B/B Cvd
04-110	30 cm	B/B Cvd



Operating Scissors

04-111	11.5 cm	S/B Str.
04-112	12.5 cm	S/B Str.
04-113	13 cm	S/B Str.
04-114	14.5 cm	S/B Str.
04-115	16 cm	S/B Str.
04-116	18 cm	S/B Str.
04-117	20 cm	S/B Str.
04-118	23 cm	S/B Str.
04-119	25 cm	S/B Str.
04-120	28 cm	S/B Str.
04-121	30 cm	S/B Str.



Operating Scissors

04-122	11.5 cm	S/B Cvd
04-123	12.5 cm	S/B Cvd
04-124	13 cm	S/B Cvd
04-125	14.5 cm	S/B Cvd
04-126	16 cm	S/B Cvd
04-127	18 cm	S/B Cvd
04-128	20 cm	S/B Cvd
04-129	23 cm	S/B Cvd
04-130	25 cm	S/B Cvd
04-131	28 cm	S/B Cvd
04-132	30 cm	S/B Cvd

OPERATING & DISSECTING SCISSORS



Bedienen & Präparierscheren

D'exploitation & Ciseaux de dissection

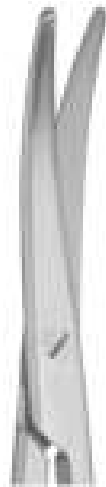
Funcionamiento y disección Tijeras

Forbici di funzionamento e di dissezione

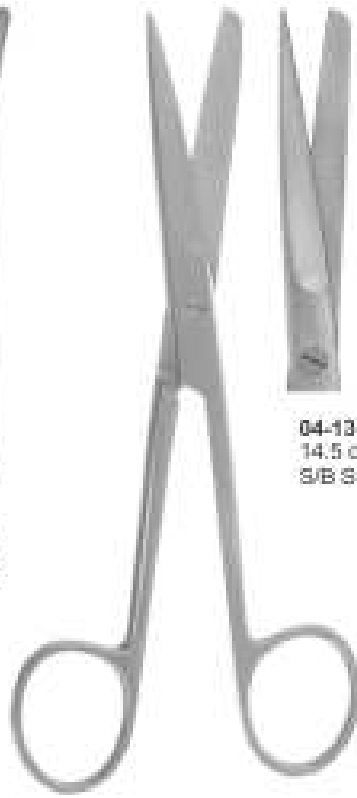


04-133
12.5 cm
B/B Str.

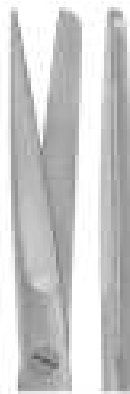
LANDOLT OPERATING
SCISSORS



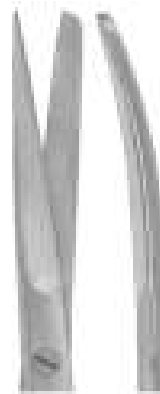
04-134
12.5 cm
B/B Cvd.



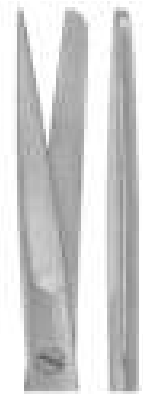
DEAVER OPERATING,
DISSECTING SCISSORS



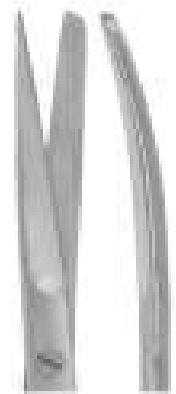
04-135
14.5 cm
S/B Str.



04-136
14.5 cm
S/B Cvd.



04-137
14.5 cm
S/B Str.
Saw Edge.

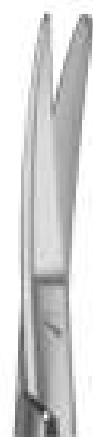


04-138
14.5 cm
S/B Cvd.
Saw Edge.



04-139
14.5 cm
S/B Str.

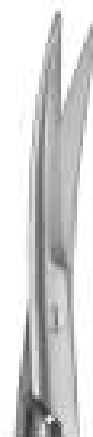
LONGE OPERATING,
DISSECTING SCISSORS



04-140
14.5 cm
S/B Cvd.



04-141
14.5 cm
S/B Str.
Saw Edge.



04-142
14.5 cm
S/S Cvd.
Saw Edge.



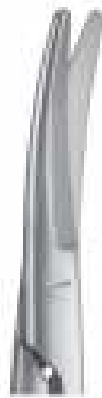
INCISION OPERATING SCISSORS



04-143 13.0 cm
04-144 14.5 cm
S/S Str.



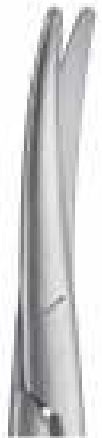
04-145
14.5 cm
04-146
15.0 cm
04-147
17.0 cm
04-148
19.5 cm
04-149
21.0 cm
04-150
23.0 cm
B/B, Str.



04-151
14.5 cm
04-152
15.0 cm
04-153
17.0 cm
04-154
19.5 cm
04-155
21.0 cm
04-156
23.0 cm
B/B, Cvd.



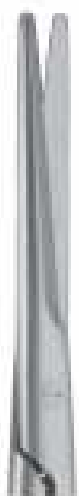
04-157
15.0 cm
04-158
17.0 cm
04-159
19.5 cm
04-160
21.0 cm
B/B, Str.



04-161
15.0 cm
04-162
17.0 cm
04-163
19.5 cm
04-164
21.0 cm
B/B, Cvd.

MAYO DISSECTING & GYNECOLOGICAL SCISSORS

MAYO-STILLE DISSECTING & GYNECOLOGICAL SCISSORS



04-165
22.5 cm
B/B, Str.



04-166
22.5 cm
B/B, Cvd.



04-167
17.0 cm
B/B, Cvd.



04-168
17.0 cm
B/B, Str.

MAYO-HARRINGTON DISSECTING & GYNECOLOGICAL SCISSORS

MAYO-NOBLE DISSECTING & GYNECOLOGICAL SCISSORS

OPERATING & DISSECTING SCISSORS



Bedienen & Präparierscheren

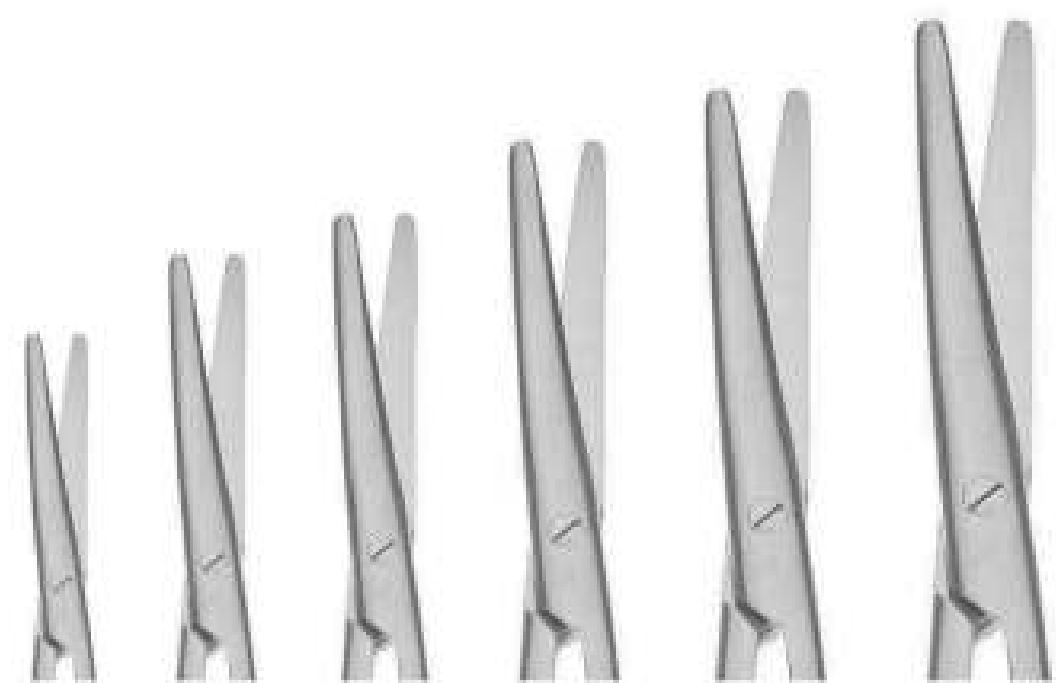
D'exploitation & Ciseaux de dissection

Funcionamiento y disección Tijeras

Forbici di funzionamento e di dissezione



**METZENBAUM OPERATING,
DISSECTING SCISSORS
BLUNT/BLUNT STR.**



04-168
14.5 cm
B/B Str.

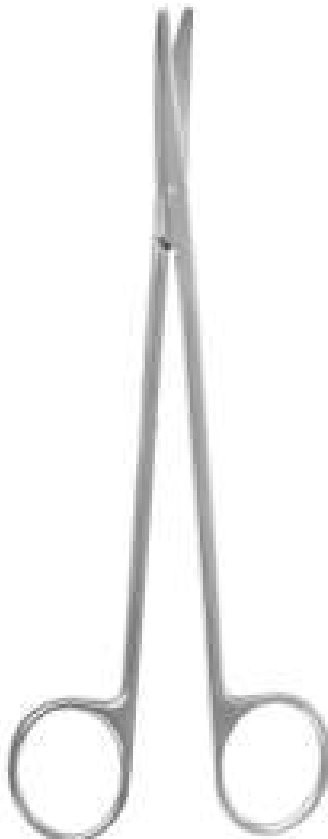
04-170
18 cm
B/B Str.

04-171
20 cm
B/B Str.

04-172
23 cm
B/B Str.

04-173
25 cm
B/B Str.

04-174
28 cm
B/B Str.



**METZENBAUM OPERATING,
DISSECTING SCISSORS
BLUNT/BLUNT CVD.**



04-175
14.5 cm
B/B Cvd.

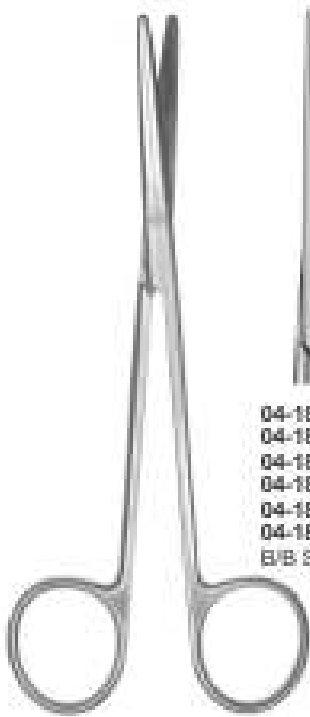
04-176
18 cm
B/B Cvd.

04-177
20 cm
B/B Cvd.

04-178
23 cm
B/B Cvd.

04-179
25 cm
B/B Cvd.

04-180
28 cm
B/B Cvd.



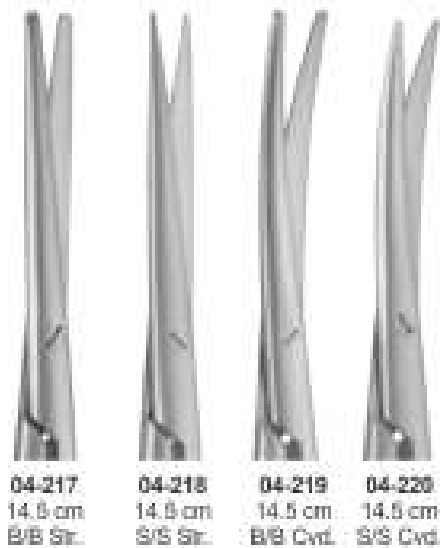
**METZENBAUM-NELSON
SCISSORS**



**METZENBAUM-NELSON
SCISSORS**



**METZENBAUM-FINO
SCISSORS**



**METZENBAUM-FINO
SCISSORS**



OPERATING & DISSECTING SCISSORS



Bedienen & Präparierscheren

D'exploitation & Ciseaux de dissection

Funcionamiento y disección Tijeras

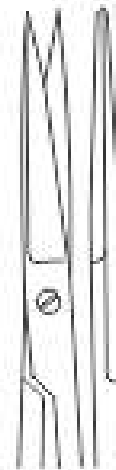
Forbici di funzionamento e di dissezione



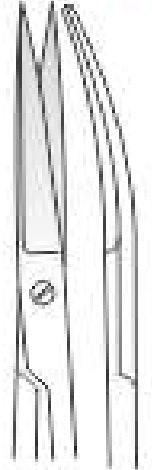
**RICHTER OPERATING,
DISSECTING SCISSORS**
04-230 14.5cm
Angled



**JOSEPH OPERATING,
DISSECTING SCISSORS**



04-231
14cm
S/S Str.



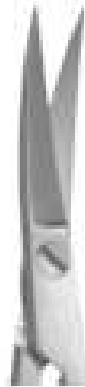
04-232
14cm
S/S Cvd.



**KELLY OPERATING,
DISSECTING SCISSORS**



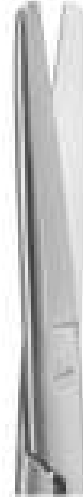
04-233
16cm
04-234
18cm
S/S Str.



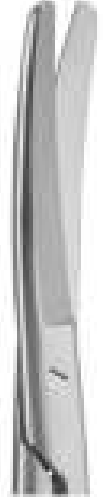
04-235
16cm
04-236
18cm
S/S Cvd.

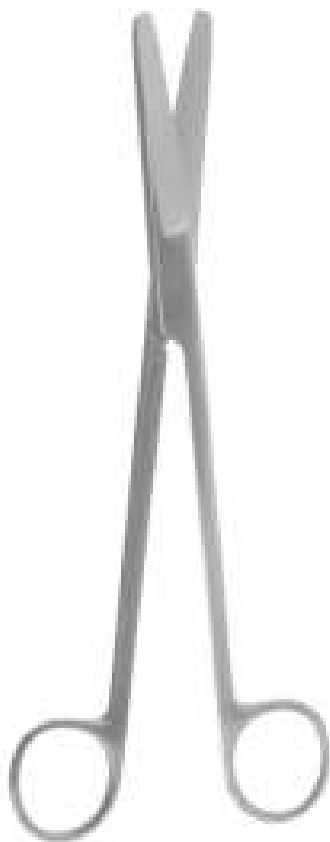


**DOYEN OPERATING,
DISSECTING SCISSORS**
04-237 17.5 cm
B/B, Str.



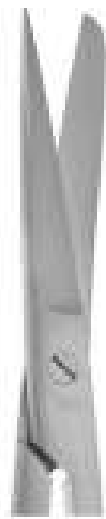
**DOYEN OPERATING,
DISSECTING SCISSORS**
04-238 17.5 cm
B/B, Cvd.





SIMS DISSECTING & GYNECOLOGICAL SCISSORS

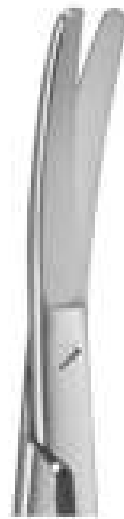
04-239 20cm
04-240 23cm
Str, B/B



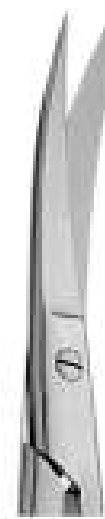
04-241 20cm
04-242 23cm
Str, S/B



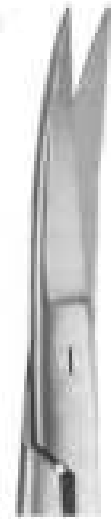
04-243 20cm
04-244 23cm
Str, S/S



04-245 20cm
04-246 23cm
Cvd, B/B



04-247 20cm
04-248 23cm
Cvd, S/B



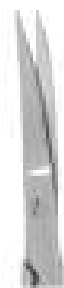
04-249 20cm
04-250 23cm
Cvd, S/S



Iris Scissors



04-251 09 cm
04-252 10.5 cm
04-253 11.5 cm
04-254 12.0 cm
S/S Str.



04-255 09 cm
04-256 10.5 cm
04-257 11.5 cm
04-258 12.0 cm
S/S Cvd.



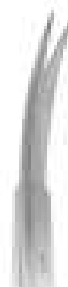
04-259
11.5 cm
Angular Left.



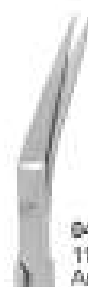
04-262 9 cm
04-263 10cm
04-264 11.5cm
04-265 12cm
S/S Str.



04-266 9 cm
04-267 10cm
04-268 11.5cm
04-269 12cm
S/S Cvd.



04-260
11.5 cm
Laterally Cvd.



04-261
11.5 cm
Angular Right



Iris Scissors

OPERATING SCISSORS

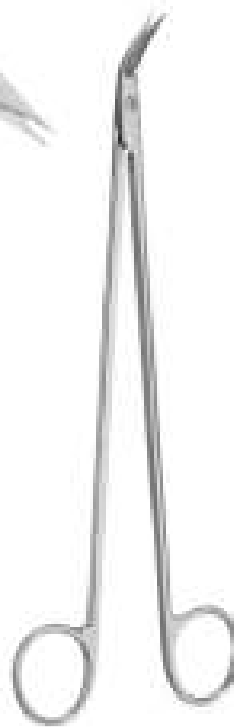
Chirurgische scheren | Ciseaux à chirurgie
 Tijeras Para Cirugia | Forbici per chirurgia



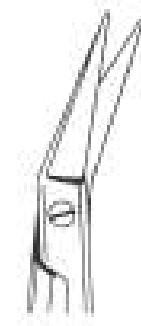
VASCULAR SCISSORS
 04-270 19cm
 S/S Angled 125°



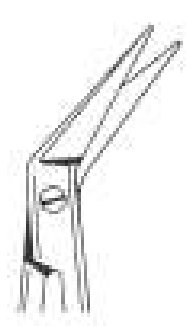
COOLEY REVERSE CUT SCISSORS
 04-271 17cm
 S/S angled 125°



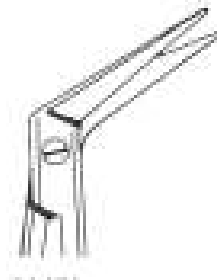
POTTS-SMITH VASCULAR SCISSORS
 S/S Angled



04-272
 19cm
 25°



04-273
 19cm
 45°



04-274
 19cm
 60°



04-275
 19cm
 125°



HEGEMANN-DIETRICH VASCULAR SCISSORS
 S/S Angled



25°
 04-276 16cm
 04-277 19cm



45°
 04-278 16cm
 04-279 19cm



60°
 04-280 16cm
 04-281 19cm



90°
 04-282 16cm
 04-283 19cm



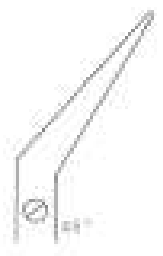
125°
 04-284 16cm
 04-285 19cm



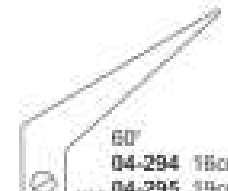
DE BAKLEY VASCULAR SCISSORS
 S/S Angled



25°
 04-286 16cm
 04-287 19cm
 04-288 23cm
 04-289 28cm



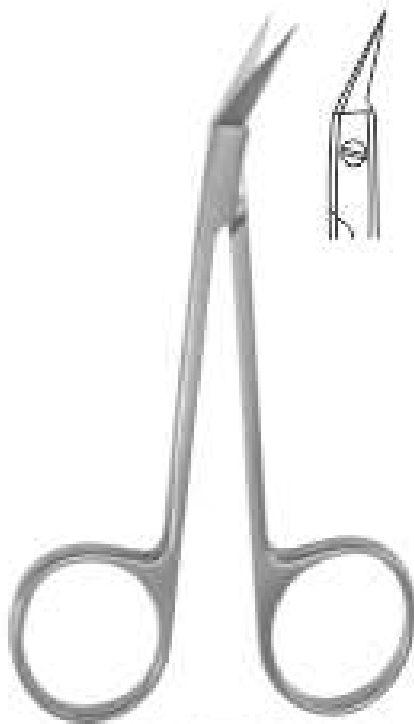
45°
 04-290 16cm
 04-291 19cm
 04-292 23cm
 04-293 28cm



60°
 04-294 16cm
 04-295 19cm
 04-296 23cm
 04-297 28cm

VASCULAR SCISSORS

Gefäßschere	Ciseaux vasculaires
Tijeras vasculares	Forbici vascolari



O'BRIEN VASCULAR SCISSORS
04-298 9cm
S/S Angled



HEATH VASCULAR SCISSORS
04-299 15cm
S/S Double Cvd.

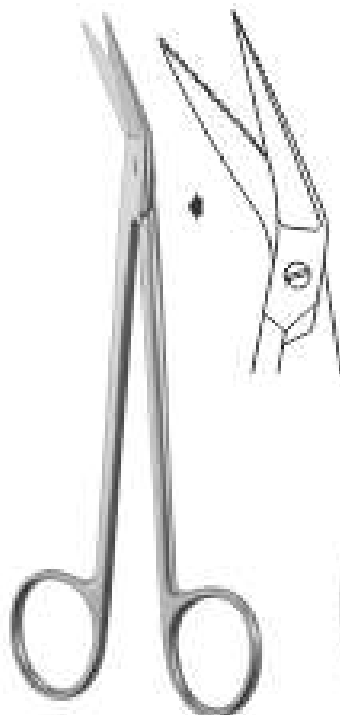


COOLEY VASCULAR SCISSORS
04-300 18.4 cm, 1 mm
04-301 18.4 cm, 1.5 mm
probe point on tip.
S/S Angled 45°

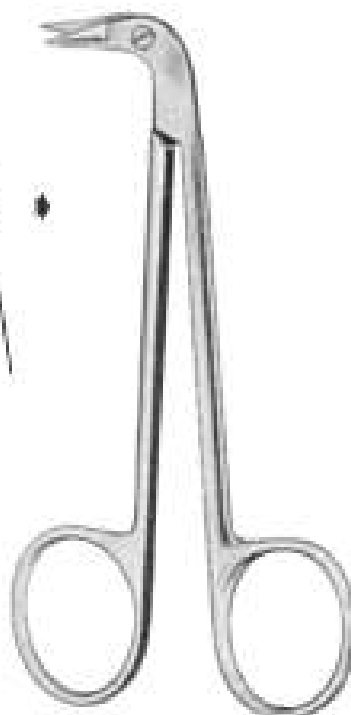


04-302
17cm
Serrated
Blade S/S
Double Cvd.

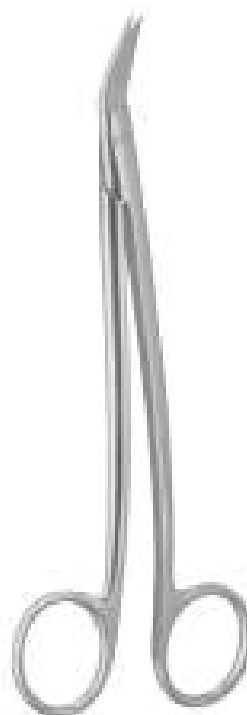
DISSECTING & NASAL SCISSORS



Locklin Dissecting Scissors
04-303 16.5cm
S/S



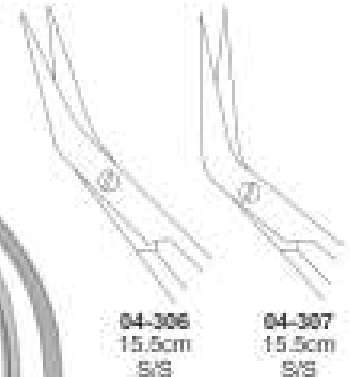
FAVALORO CORONARY
04-304 10.5 cm
S/S Angled 90°



ENT-DEAN SCISSORS
04-305 17cm
S/S Double Cvd.
Serrated



DE BAKHEY VASCULAR SCISSORS

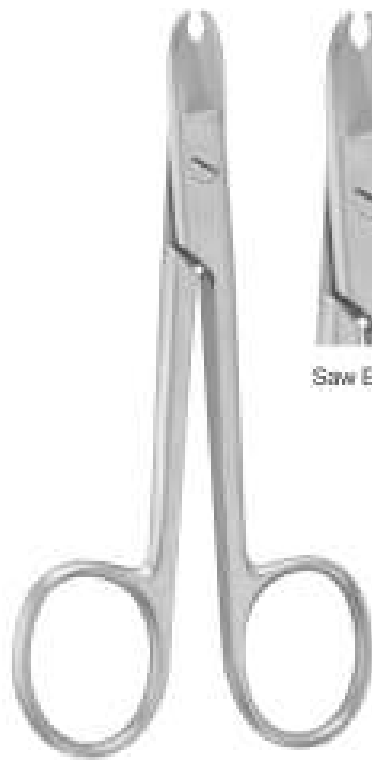


04-306
15.5cm
S/S

04-307
15.5cm
S/S

STITCH SCISSORS

stitch Schere | point de ciseaux
 Coser Tijeras | Stitch Forbici



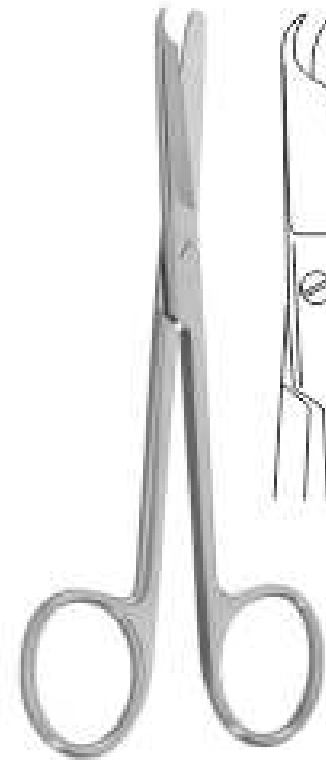
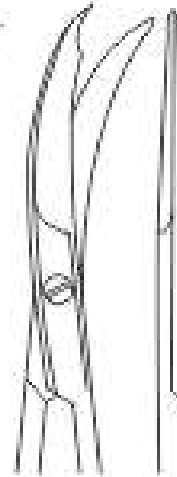
STITCHES SCISSORS
 04-308 12.0 cm
 Str.



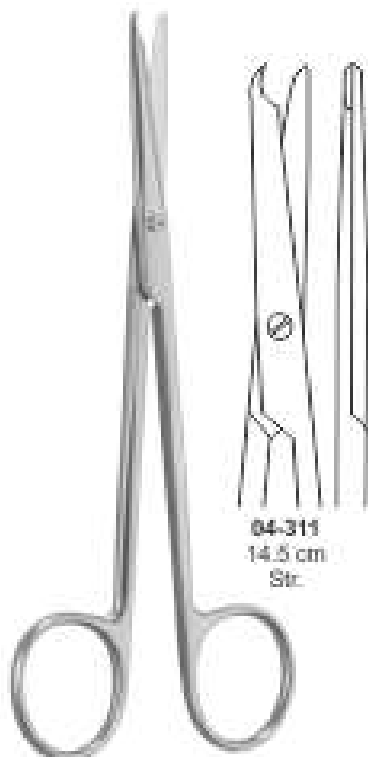
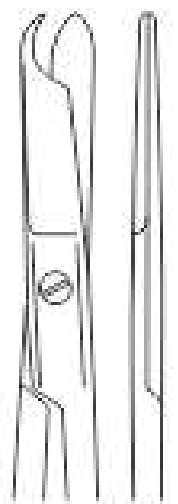
Saw Edge



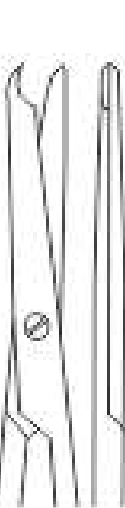
NORTHBENT STITCHES SCISSORS
 04-309 12.5 cm
 Cvd.



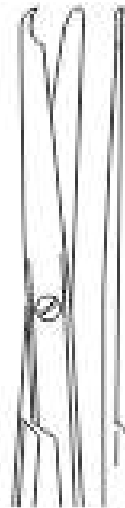
LITTAUER STITCH SCISSORS
 04-310 14 cm
 Str.



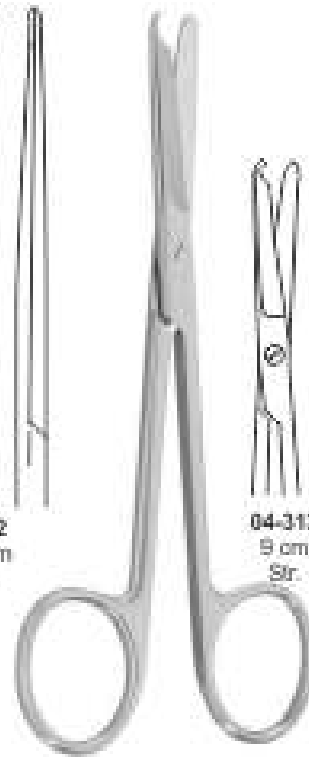
BUCK STITCH SCISSORS



04-311
 14.5 cm
 Str.



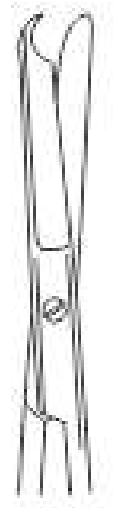
04-312
 18.0 cm
 Str.



SPENCER STITCH SCISSORS



04-313
 9 cm
 Str.



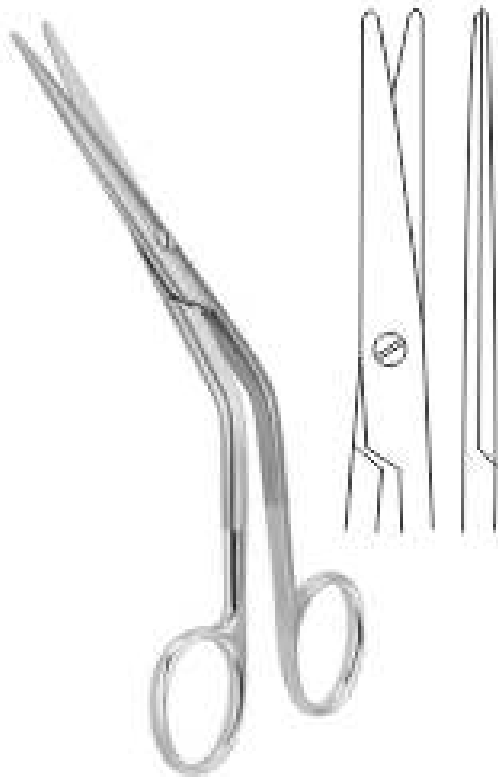
04-314
 11.5 cm
 Str.



SHORTBENT STITCH SCISSORS
 04-315 8 cm
 Cvd.

Tonsillensteinen Schere, Nasenschere
Tijeras de amígdalas, tijeras nasales

Ciseaux d'amygdales, Ciseaux nasaux
Tonsile forbici, forbici nasali



COTTLE SCISSORS
04-316 16 cm
B/B, Angled



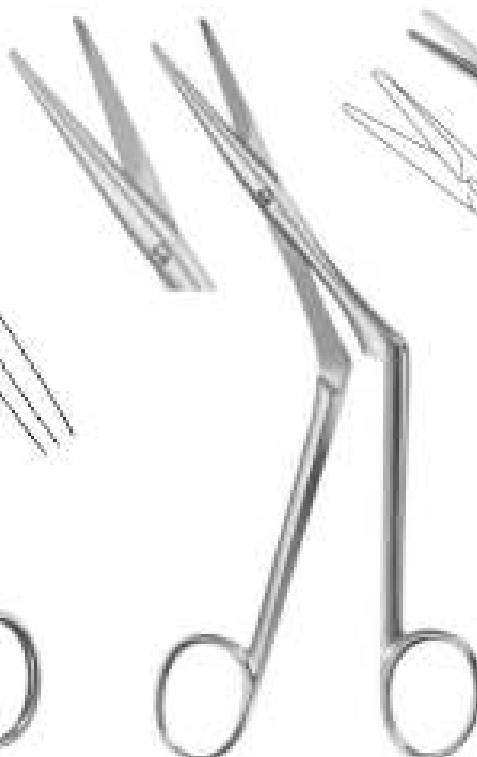
FOMON SCISSORS
04-317 14.5 cm
B/B, Angled



SAILER SCISSORS
04-318 17.0 cm
B/B, Angled



HEYMANN SCISSORS
04-319 18 cm
04-320 19.5 cm
B/B, Angled



HEYMANN SCISSORS
04-321 18.0 cm
B/B, Angled



OLIVECRONA VASCULAR SCISSORS
04-322 21.0 cm
B/B

GUM & OPERATING SCISSORS

Chirurgische scheren, Gum Scheren
Goma Tijeras y tijeras de funcionamiento

Gum Ciseaux et Ciseaux d'exploitation
Gum Forbici & Forbici Operativi



GOOD SCISSORS
04-323 - 19.0 cm
Probe End, Cvd.



PRINCE SCISSORS
04-324 - 17.5 cm
B/B, Cvd.

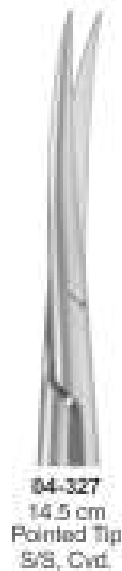


HALLE SCISSORS
04-325 - 19.0 cm
B/B, Cvd.



04-326
14.5 cm
Pointed Tip
S/S, Str.

SULLIVAN SCISSORS
One Tooth Is Serrated As Per



04-327
14.5 cm
Pointed Tip
S/S, Cvd.



MOD. BONN SCISSORS
04-328 - 8.0 cm
S/S, Str.



MOD. BONN SCISSORS
04-329 - 8.0 cm
S/S, Cvd.

WIRE CUTTING SCISSORS

Draht-Ausschnitt-Scheren

Ciseaux de coupe de câbles

Tijeras de corte de alambre

Filo da taglio Forbici



04-330
10.5 cm
04-331
12.0 cm
B/B Str.
04-332
10.5 cm
04-333
12.0 cm
B/B Str.
Saw Edge



04-334
10.5 cm
04-335
12.0 cm
S/S Str.
04-336
10.5 cm
04-337
12.0 cm
S/S Str.
Saw Edge



04-338
10.0 cm
04-339
12.0 cm
B/B Cvd.
04-340
10.0 cm
04-341
12.0 cm
B/B Cvd.
Saw Edge



04-342
10.0 cm
04-343
12.0 cm
S/S Cvd.
04-344
10.0 cm
04-345
12.0 cm
S/S Cvd.
Saw Edge

BEEBEE WIRE CUTTING SCISSORS

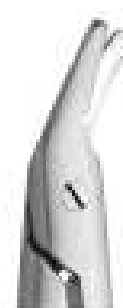
BEEBEE WIRE CUTTING SCISSORS



SYSTRUNK
04-346
13.0 cm
S/S Str.



SYSTRUNK
04-347
13.0 cm
S/S Cvd.



UNIVERSAL WIRE CUTTING SCISSORS
04-348 12 cm

NAIL NIPPERS, NAIL SCISSORS

Nagelzangen, Nagelscheren

Pinzas para uñas, tijeras de uñas

Pince à ongles, ciseaux à ongles

Tranchesi per unghie, forbici per unghie



04-349
10 cm
04-350
11.5 cm
S/S Str.

STEVENS SCISSORS



04-351
10 cm
04-352
11.5 cm
S/S Cvd.

STEVENS SCISSORS

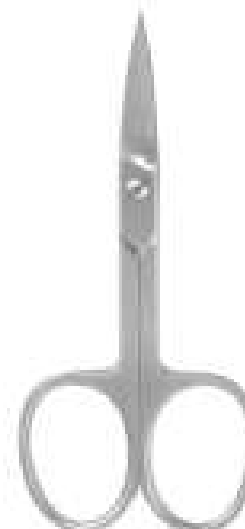


04-353
10 cm
04-354
11.5 cm
B/B Str.

STEVENS SCISSORS



04-355
10 cm
04-356
11.5 cm
B/B Cvd.



NAIL SCISSORS
04-357 9 cm S/S Cvd.



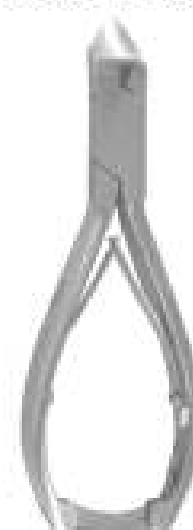
NAIL SCISSORS
04-358 9 cm
S/S Cvd.



NAIL SCISSORS
04-359 9 cm
Arrow Point Curved



NAIL NIPPERS
04-360 11 cm
04-361 13 cm
04-362 15 cm



NAIL NIPPERS
04-363 14 cm



NAIL NIPPERS
04-364 14 cm



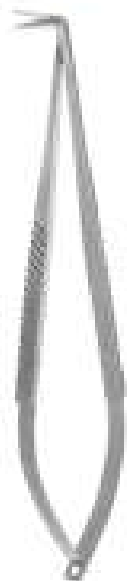
TURNBULL NIPPERS
04-365 11.5 cm
04-366 13 cm



NAIL NIPPERS
04-367 10.5 cm



COHEN NIPPERS
04-368 10.5 cm



ARTERY SCISSORS
Probe end Angled



04-369
18.0 cm
25°



04-370
18.0 cm
45°



04-371
18.0 cm
60°



04-372
18.0 cm
90°



04-373
18.0 cm
125°



04-374
18.0 cm
25°



04-375
18.0 cm
45°



04-376
18.0 cm
60°



04-377
18.0 cm
90°



04-378
18.0 cm
125°



04-379
9.0 cm
S/B Str.



04-380
9.0 cm
S/B Cvd.



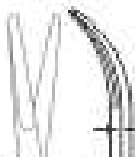
04-381
9.0 cm
S/S Str.



04-382
9.0 cm
S/S Cvd.



04-383
11.4 cm
B/B Str.



04-384
11.4 cm
B/B Cvd.



04-385
11.4 cm
S/B Str.



04-386
11.4 cm
S/B Cvd.



04-387
11.4 cm
S/S Str.



04-388
11.4 cm
S/S Cvd.



04-389
14 cm
B/B Str.



04-390
14 cm
B/B Cvd.



04-391
14 cm
S/B Str.



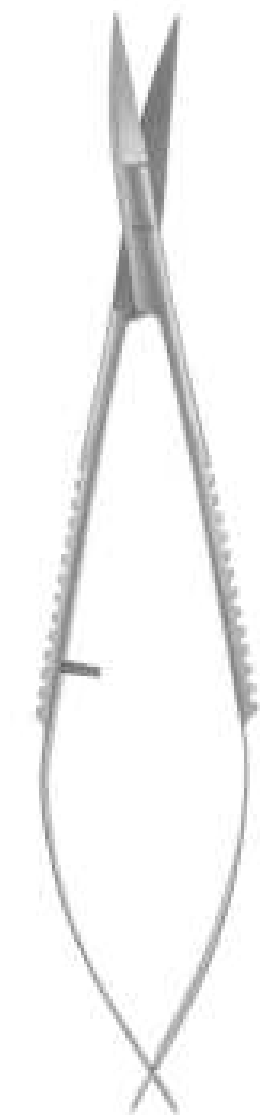
04-392
14 cm
S/B Cvd.



04-393
14 cm
S/S Str.



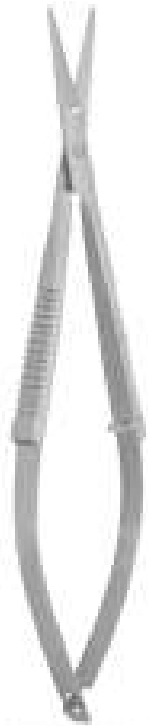
04-394
14 cm
S/S Cvd.



CASTROVIEJO SCISSORS
Spring Type

MICRO SCISSORS

Mikroscheren | micro Ciseaux
 Micro Tijeras | Micro Forbier



NOYES SCISSORS
Spring Handle



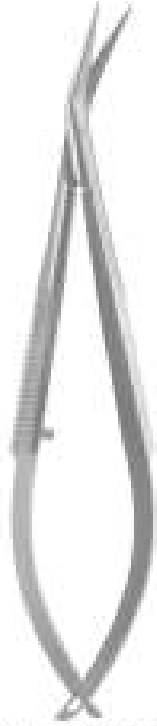
04-395
12 cm
S/S



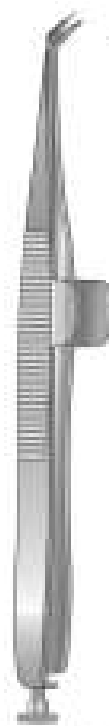
04-396
12 cm
S/B



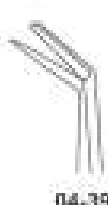
04-397
12 cm
B/B



NOYES SCISSORS
Spring Handle
04-398 12cm
Angled,



WECKER SCISSORS
Angled



04-399
11.0 cm
S/B



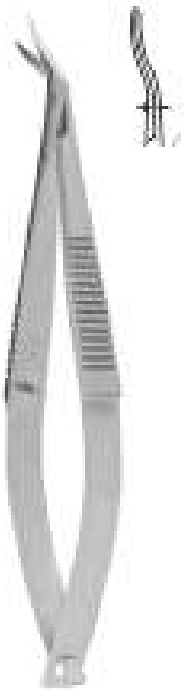
04-401
11.0 cm
S/S



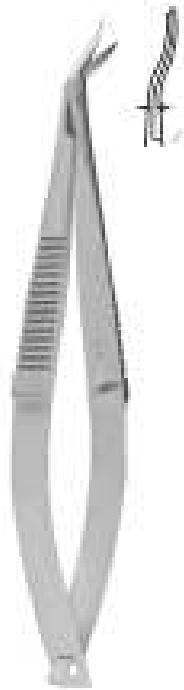
04-400
11.0 cm
B/B



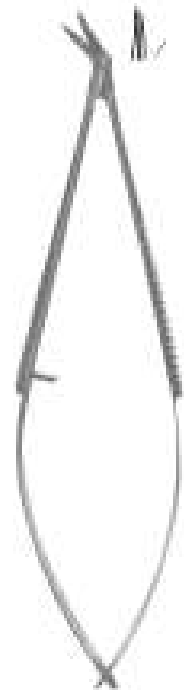
BARRAQUER SCISSORS
04-402 Sharp Points
04-403 Blunt Points
5.5 cm



CASTROVIEJO CORNEAL MICRO SCISSORS
04-404 11cm
Left Angled,
Spring Handle



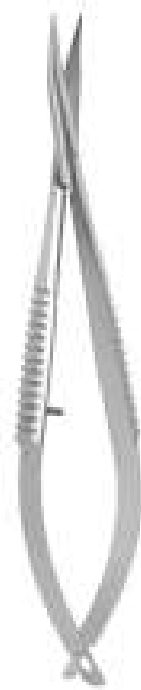
CASTROVIEJO CORNEAL MICRO SCISSORS
04-405 11cm
Right Angled,
Spring Handle



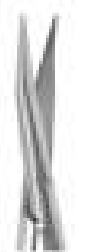
TROUTMAN MICRO SCISSORS
04-406 10cm
Left Angled,
Spring Handle



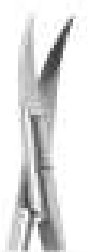
TROUTMAN MICRO SCISSORS
04-407 10cm
Right Angled,
Spring Handle



WESTCOTT MICRO SCISSORS



04-408
11.0 cm
S/S Str.



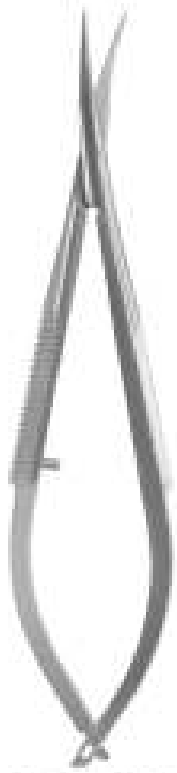
04-409
13.3 cm
S/S Str.

04-410
11.0 cm
S/S Cvd.

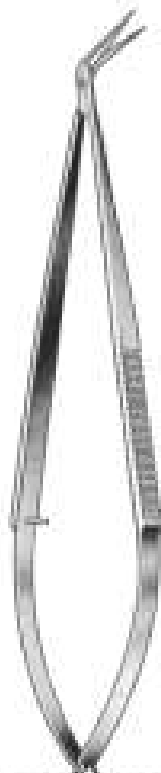
04-411
13.3 cm
S/S Cvd.

MICRO SCISSORS

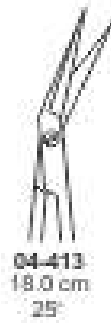
Mikroscheren | *micro Ciseaux*
Micro Tijeras | *Micro Forbici*



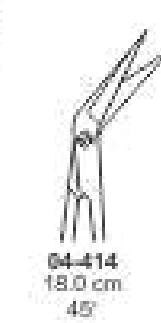
MICRO SCISSORS
04-412 12cm
S/S, Cvd.



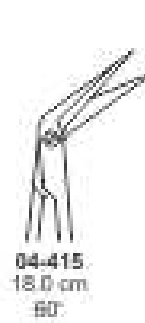
MICRO SCISSORS
S/S, Angled



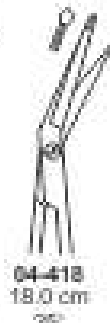
04-413
18.0 cm
25°



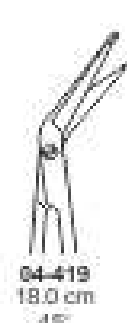
04-414
18.0 cm
45°



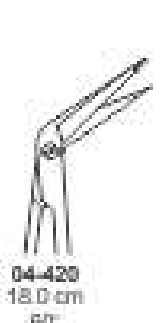
04-415
18.0 cm
60°



04-418
18.0 cm
25°



04-419
18.0 cm
45°



04-420
18.0 cm
60°



04-416
18.0 cm
90°



04-417
18.0 cm
125°



MICRO SCISSORS
S/S, Angled pointed probe



04-421
18.0 cm
90°



04-422
18.0 cm
125°



YASARGILL SCISSORS



04-423 16 cm
04-424 20 cm
04-425 22.5cm
S/S, Str.



04-426 16cm
04-427 20cm
04-428 22cm
S/S, Cvd.



04-429 16cm
04-430 20cm
04-431 22cm
B/B, Str.



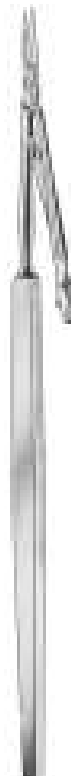
04-432 16cm
04-433 20cm
04-434 22cm
S/S, Str.



04-435 16cm
04-436 20cm
04-437 22cm
S/S, Cvd.



04-438 16cm
04-439 20cm
04-440 22cm
B/B, Cvd.



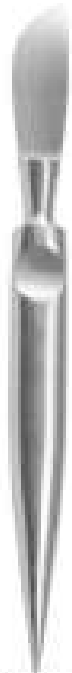
NOYES MICRO SCISSORS
04-441 15cm
S/S



NOYES MICRO SCISSORS
04-442 14.5cm
S/S

PLASTER SCISSORS

Gips Schere | plâtre Ciseaux
 Tijeras Yeso | intonaco Forbici



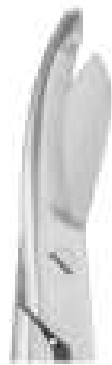
ESMARCH KNIFE
04-443 18cm



BRUNS SCISSORS



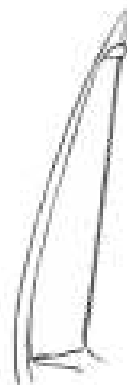
04-444
24 cm
Cvd, Probe End



04-445
24cm
Cvd, Serrated
Probe End



**LISTER-EXCENTRIC
PLASTER SCISSORS**
04-446 16 cm
04-447 19 cm
Angled, Probe End



Saw Edge Upper
Teeth is Serrated



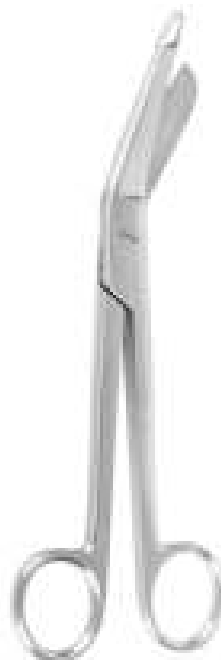
**LISTER BANDAGE PLASTER
Scissors, one large ring**
04-448 9 cm
04-449 11 cm
04-450 14 cm
04-451 15 cm
04-452 18 cm
04-453 20 cm
Angled, Probe End



BERGMANN SCISSORS
04-454 23 cm
Angled, Probe End



ESMARCH SCISSORS
04-455 20 cm
04-456 23 cm
Angled, Probe End



**LISTER BANDAGE
PLASTER SCISSORS**
04-457 9 cm
04-458 11 cm
04-459 14 cm
04-460 15 cm
04-461 18 cm
04-462 20 cm
Angled, Probe End



PLASTER SCISSORS
04-463 17 cm
Angled



**BURNHAM BANDAGE
PLASTER SCISSORS**
04-464 14 cm
Angled

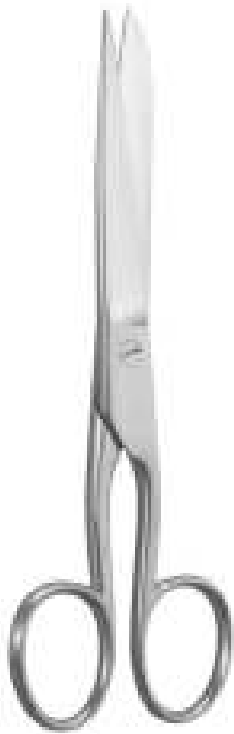
PLASTER SCISSORS

Gips Schere

plâtre Ciseaux

Tijeras Yeso

Intonaco Forbici



BANDAGE SCISSORS
04-465 16.0 cm



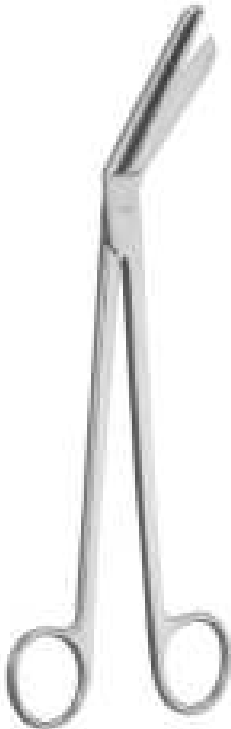
**SMITH (Mod. Usa)
PLASTER SCISSORS**
04-466 16 cm
04-467 18 cm
04-468 20 cm
04-469 23 cm



**LÖRENZ PLASTER
SCISSORS**
04-470 23 cm
B/B, Cvd



**LANGE BANDAGE
SCISSORS**
04-471 18.0 cm
B/B



**BRAUN-STÄDLER
PLASTER SCISSORS**
04-472 14cm
04-473 22cm
B/B, Angled



**BUSCH PLASTER
SCISSORS**
04-474 13 cm
04-475 16 cm
B/B, Cvd.



**KNOWLES PLASTER
SCISSORS**
04-476 14 cm
Str. Probe End



**KNOWLES PLASTER
SCISSORS**
04-477 14 cm
Angled, Probe End



**WALDMANN PLASTER
SCISSORS**
04-478 18 cm
Probe End

PLASTER SCISSORS

Gips Schere
Tijeras Yeso

plâtre Ciseaux
intonaco Forbici



WALDMANN SCISSORS
04-479 18 cm



SCHUMACHER PLASTER SCISSORS
04-480 16 cm



MODIFIED-USA PLASTER SCISSORS
04-481 10.5 cm



MARBACH PLASTER SCISSORS
04-482 15.5 cm
Probe End, Serrated blade



SEUTIN PLASTER SCISSORS
04-483 20cm
Probe End



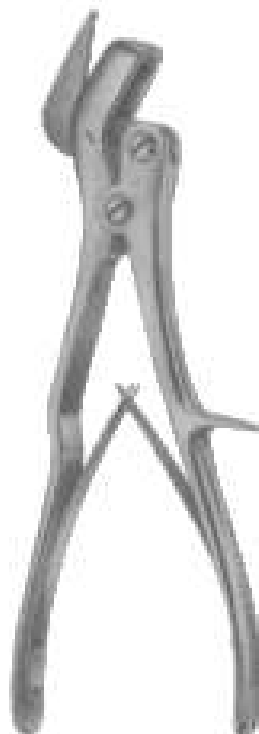
SEUTIN PLASTER SCISSORS
04-484 23cm
Probe End

PLASTER SHEARS

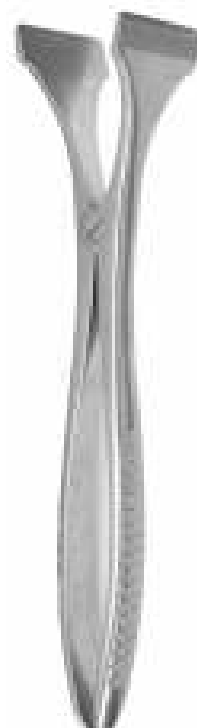
GipsScheren	plâtres Ciseaux
Tijeras Yeso	Cesate In gesso



Stille Plaster Shears
04-485 23 cm
04-486 26 cm
04-487 37 cm
04-488 Spare Blade



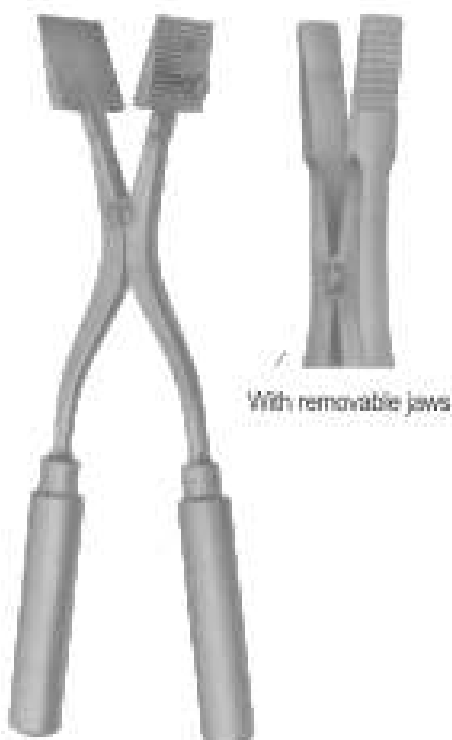
STILLE PLASTER SHEARS
04-489 24 cm
04-490 Spare Blade



HENNIG PLASTER CAST SPREADER
04-491 28 cm



MODEL USA CAST SPREADER PLASTER
04-492 23 cm 3 Prong



SPREADER PLASTER
04-493 29 cm



WOLFF SPREADER PLASTER
04-494 18 cm
04-495 24 cm

SUPER CUT SCISSORS



Super Cut Schere | Ciseaux SuperCut
 Súper Cut Tijeras | Forbici SuperCut



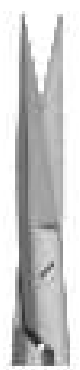
Standard Operating Super Cut Scissors



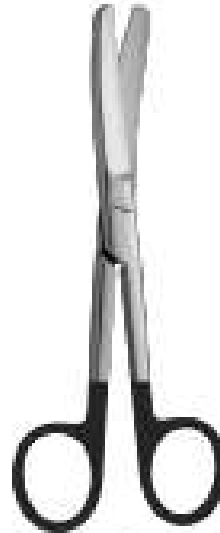
04-496
14.5 cm
04-497
16.5 cm
Str. B/B



04-498
14.5 cm
04-499
16.5 cm
Str. S/B



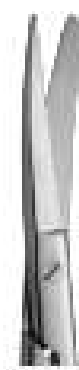
04-500
14.5 cm
04-501
16.5 cm
Str. S/S



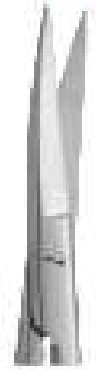
Standard Operating Super Cut Scissors



04-502
14.5 cm
04-503
16.5 cm
Cvd. B/B



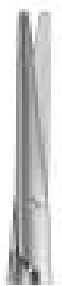
04-504
14.5 cm
04-505
16.5 cm
Cvd. S/B



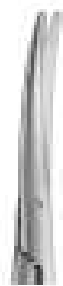
04-506
14.5 cm
04-507
16.5 cm
Cvd. S/S



Lexor Operating Super Cut Scissors



04-508 16 cm
04-509 21 cm
B/B, Str.



04-510 16.5 cm
04-511 21 cm
B/B, Cvd.



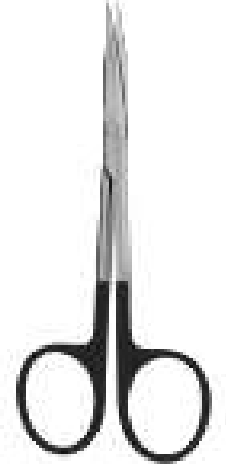
Safety Super Cut Scissors
04-512 Str.
04-513 Cvd.
9.0 cm, Probe Ends



Goldman-fox Super Cut Scissors
04-514 Str.
04-515 Cvd.
9.0 cm, S/S



Stevens Tenotomy Super Cut Scissors
04-516 Str.
04-517 Cvd.
9.0 cm, B/B



Stevens Tenotomy Super Cut Scissors
04-518 Str.
04-519 Cvd.
11.5 cm, S/S



BABY METZENBAUM SUPER CUT SCISSORS
04-520 11.5 cm
B/B, Str.



BABY METZENBAUM SUPER CUT SCISSORS
04-521 11.5 cm
B/B, Cvd.



IRIS SUPER CUT SCISSORS
04-522 9.0 cm
04-523 11.5 cm
S/S, Str.



IRIS SUPER CUT SCISSORS
04-524 9.0 cm
04-525 11.5 cm
S/S, Cvd.



**Operating Scissors, S/S Str.
T/C Insert**

04-526	11.5 cm
04-527	13.0 cm
04-528	14.0 cm
04-529	15.0 cm
04-530	16.0 cm
04-531	17.5 cm
04-532	18.5 cm
04-533	20.0 cm



**Operating Scissors, S/S Cvd.
T/C Insert**

04-534	11.5 cm
04-535	13.0 cm
04-536	14.0 cm
04-537	15.0 cm
04-538	16.0 cm
04-539	17.5 cm
04-540	18.5 cm
04-541	20.0 cm



**Operating Scissors, B/B Str.
T/C Insert**

04-542	11.5 cm
04-543	13.0 cm
04-544	14.0 cm
04-545	15.0 cm
04-546	16.0 cm
04-547	17.5 cm
04-548	18.5 cm
04-549	20.0 cm



**Operating Scissors, B/B Cvd.
T/C Insert**

04-550	11.5 cm
04-551	13.0 cm
04-552	14.0 cm
04-553	15.0 cm
04-554	16.0 cm
04-555	17.5 cm
04-556	18.5 cm
04-557	20.0 cm



**Operating Scissors, S/B
Standard Str. T/C Insert**

04-558	11.5 cm
04-559	13.0 cm
04-560	14.0 cm
04-561	15.0 cm
04-562	16.0 cm
04-563	17.5 cm
04-564	18.5 cm
04-565	20.0 cm



**Operating Scissors, S/B
Standard Cvd. T/C Insert**

04-566	11.5 cm
04-567	13.0 cm
04-568	14.0 cm
04-569	15.0 cm
04-570	16.0 cm
04-571	17.5 cm
04-572	18.5 cm
04-573	20.0 cm

OPERATING SCISSORS T.C.



Chirurgische scheren
Tijeras quirúrgicas

Ciseaux chirurgicaux
Forbici per chirurgia



Metzenbaum Operating Scissors T/C Insert

04-574 11.5 cm	04-576 11.5 cm	04-578 11.5 cm
04-575 14.5 cm	04-577 14.5 cm	04-579 14.5 cm
B/B Str.	S/B Str.	S/S Str.



Metzenbaum Operating Scissors T/C Insert

04-580 11.5 cm	04-582 11.5 cm	04-584 11.5 cm
04-581 14.5 cm	04-583 14.5 cm	04-585 14.5 cm
B/B Cvd.	S/B Cvd.	S/S Cvd.



Metzenbaum-Fino Operating Scissors T/C Insert

04-586 14.5 cm	04-590 14.5 cm
04-587 18 cm	04-591 18 cm
04-588 20 cm	04-592 20 cm
04-589 23 cm	04-593 23 cm
B/B Str.	B/B Cvd.



Metzenbaum-Fino Operating Scissors T/C Insert

04-594 14.5 cm	04-598 14.5 cm
04-595 18 cm	04-599 18 cm
04-596 20 cm	04-600 20 cm
04-597 23 cm	04-601 23 cm
S/S Str.	S/S Cvd.



Metzenbaum-Nelson Operating Scissors T/C Insert

04-602 18 cm	04-608 18 cm	04-614 18 cm
04-603 20 cm	04-609 20 cm	04-615 20 cm
04-604 23 cm	04-610 23 cm	04-616 23 cm
04-605 25 cm	04-611 25 cm	04-617 25 cm
04-606 28 cm	04-612 28 cm	04-618 28 cm
04-607 30 cm	04-613 30 cm	04-619 30 cm
B/B Str.	S/B Str.	S/S Str.

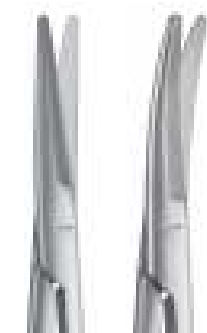


Metzenbaum-Nelson Operating Scissors T/C Insert

04-620 18 cm	04-626 18 cm	04-632 18 cm
04-621 20 cm	04-627 20 cm	04-633 20 cm
04-622 23 cm	04-628 23 cm	04-634 23 cm
04-623 25 cm	04-629 25 cm	04-635 25 cm
04-624 28 cm	04-630 28 cm	04-636 28 cm
04-625 30 cm	04-631 30 cm	04-637 30 cm
B/B Cvd.	S/B Cvd.	S/S Cvd.



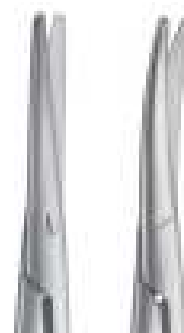
**Mayo Dissecting &
Gynecological Scissors
T/C Insert**



04-638 14.5 cm	04-642 14.5 cm
04-639 15.0 cm	04-643 15.0 cm
04-640 17.0 cm	04-644 17.0 cm
04-641 23.0 cm	04-645 23.0 cm
B/B, Str.	B/B, Cvd.



**Mayo-stille Dissecting &
Gynecological Scissors
T/C Insert**



04-646 15.0 cm	04-650 15.0 cm
04-647 17.0 cm	04-651 17.0 cm
04-648 19.5 cm	04-652 19.5 cm
04-649 21.0 cm	04-653 21.0 cm
B/B, Str.	B/B, Cvd.



ENT-DEAN SCISSORS
04-654 17 cm
S/S Double Cvd.
Serrated



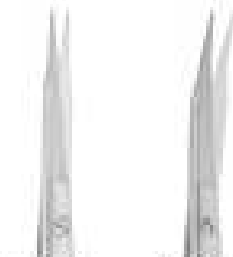
**KELLY OPERATING,
DISSECTING SCISSORS**



04-655 16.0 cm	04-657 16.0 cm
04-656 18.0 cm	04-658 18.0 cm
S/S Str.	S/S Cvd.



**Goldmann-Fox
Operating Scissors
T/C Insert**



04-659 13 cm	04-660 13 cm
S/S Str.	S/S Cvd.



WIRE CUTTING SCISSORS
04-661 12 cm

OPERATING SCISSORS T.C.



Chirurgische scheren
Tijeras quirúrgicas

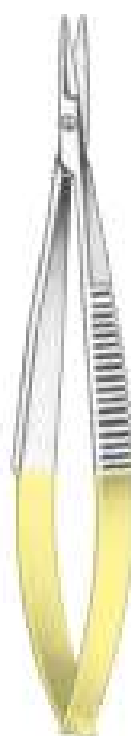
Ciseaux chirurgicaux
Forbici per chirurgia



Lister Bandage Plaster Scissors T/C Insert,
one large ring
04-662 8.9cm
04-663 11.43 cm
04-664 14 cm
04-665 16 cm
04-666 18 cm
04-667 20 cm



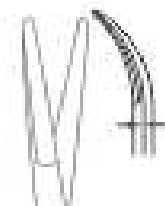
Lister Bandage Plaster Scissors, T/C Insert
04-668 8.9cm
04-669 11.43 cm
04-670 14 cm
04-671 16 cm
04-672 18 cm
04-673 20 cm



Castroviejo Scissors T/C Insert



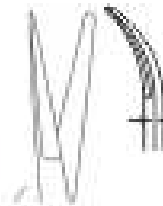
04-674
14 cm
B/B Str.



04-675
14 cm
B/B Cvd.



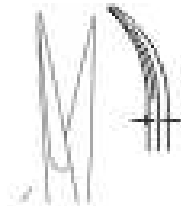
04-676
14 cm
S/S Str.



04-677
14 cm
S/S Cvd.



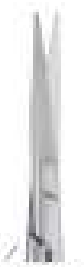
04-678
14 cm
S/S Str.



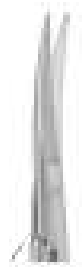
04-679
14 cm
S/S Cvd.



Joseph Operating Scissors T/C Insert



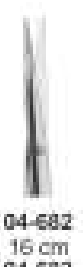
04-680
14 cm
S/S Str.



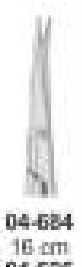
04-681
14 cm
S/S Cvd.



Reynolds Operating Scissors T/C Insert



04-682
16 cm
04-683
18 cm
S/S Str.



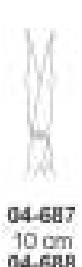
04-684
16 cm
04-685
18 cm
S/S Cvd.



Foman Operating Scissors T/C Insert
04-686
13 cm Full Bent



Stevens Operating Scissors T/C Insert



04-687
10 cm
04-688
11 cm
Str.



04-689
10 cm
04-690
11 cm
Cvd.

Universal Paramedic Shear



04-691 14cm (PINK)
04-692 16cm (PINK)
04-693 18cm (PINK)



04-709 14cm (ORANGE)
04-710 16cm (ORANGE)
04-711 18cm (ORANGE)



04-694 14cm (BLUE)
04-695 16cm (BLUE)
04-696 18cm (BLUE)



04-712 14cm (GREEN)
04-713 16cm (GREEN)
04-714 18cm (GREEN)



04-697 14cm (YELLOW)
04-698 16cm (YELLOW)
04-699 18cm (YELLOW)



04-715 14cm (WHITE)
04-716 16cm (WHITE)
04-717 18cm (WHITE)



04-700 14cm (Cyan)
04-701 16cm (Cyan)
04-702 18cm (Cyan)



04-718 14cm (RED)
04-719 16cm (RED)
04-720 18cm (RED)



04-703 14cm (BLACK)
04-704 16cm (BLACK)
04-705 18cm (BLACK)



04-721 14cm (ROYAL BLUE)
04-722 16cm (ROYAL BLUE)
04-723 18cm (ROYAL BLUE)



04-706 14cm (RED)
04-707 16cm (RED)
04-708 18cm (RED)



04-724 14cm (BLUE)
04-725 16cm (BLUE)
04-726 18cm (BLUE)



Standard Dressing Forceps
serrated

- 05-01 10.5cm
- 05-02 11.5cm
- 05-03 13cm
- 05-04 14.5cm
- 05-05 16cm
- 05-06 18cm
- 05-07 20cm
- 05-08 25cm
- 05-09 30cm



Standard Tissue Forceps
1x2 Teeth

- 05-10 10.5cm
- 05-11 11.5cm
- 05-12 13cm
- 05-13 14.5cm
- 05-14 16cm
- 05-15 18cm
- 05-16 20cm
- 05-17 25cm
- 05-18 30cm



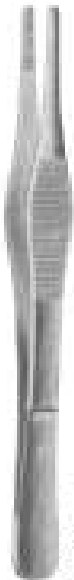
Mod. USA, Dressing Forceps
serrated

- 05-19 10.2cm
- 05-20 12cm
- 05-21 13cm
- 05-22 14.5cm
- 05-23 15.5cm
- 05-24 18cm
- 05-25 21cm
- 05-26 25cm
- 05-27 31cm



Mod. USA, Tissue Forceps
1x2 teeth

- 05-28 10.2cm
- 05-29 11.4cm
- 05-30 12.7cm
- 05-31 14.0cm
- 05-32 15.2cm
- 05-33 17.8cm
- 05-34 20.3cm
- 05-35 25.4cm
- 05-36 30.5cm



Mod. Martin Dressing Forceps

- 05-37 12.7cm
- 05-38 14.0cm



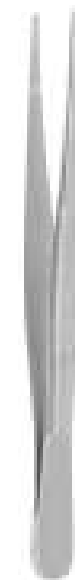
Standard Dressing Forceps
Curved, serrated

- 05-39 11.4cm
- 05-40 12.7cm
- 05-41 14.0cm
- 05-42 15.2cm
- 05-43 17.8cm
- 05-44 20.3cm
- 05-45 25.4cm
- 05-46 30.5cm



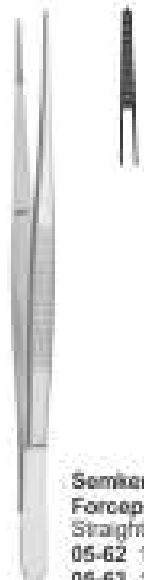
Standard Dressing Forceps
wide pattern cross serration

- 05-47 11.4cm
- 05-48 12.7cm
- 05-49 14.0cm
- 05-50 15.20cm
- 05-51 17.8cm
- 05-52 20.3cm
- 05-53 25.4cm
- 05-54 30.5cm



Standard Dressing Forceps
Narrow Point serrated

- 05-55 12.7cm
- 05-56 14.0cm
- 05-57 15.20cm
- 05-58 17.8cm
- 05-59 20.3cm
- 05-60 25.4cm
- 05-61 30.5cm



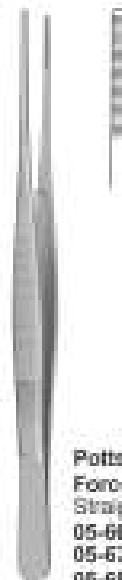
Semken Dressing Forceps
Straight Serrated

- 05-62 12.5cm
- 05-63 15.5cm



Semken Dressing Forceps
Curved Serrated

- 05-64 12.5cm
- 05-65 15.5cm



Potts-Smith Dressing Forceps
Straight Serrated

- 05-66 17.5cm
- 05-67 21cm
- 05-68 25 cm



Potts-Smith Dressing Forceps
Curved Serrated

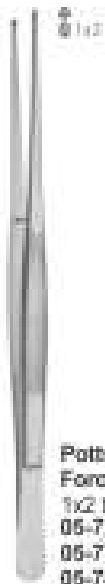
- 05-69 17.5cm
- 05-70 21cm
- 05-71 25cm

TISSUE & DRESSING FORCEPS

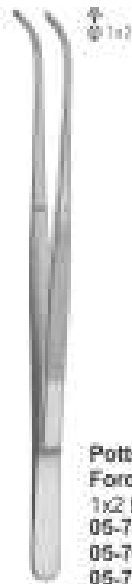


Pinces a tissu, Anatomische pinzeten
Geuebe, Pinzas de disección

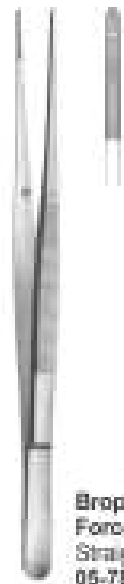
Pinzas para tejidos, Pincas à dissection
Pinze per tessuti, Pinze per dissezione



Potts-Smith Tissue Forceps
 1x2 teeth Straight
 05-72 17.5cm
 05-73 21.0cm
 05-74 25.0cm



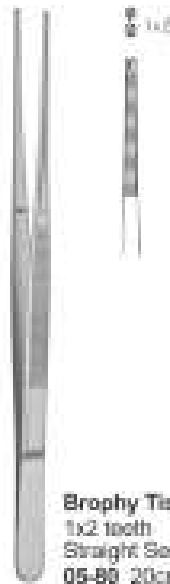
Potts-Smith Tissue Forceps
 1x2 teeth Curved
 05-75 17.5cm
 05-76 21.0cm
 05-77 25.0cm



Brophy Dressing Forceps
 Straight Serrated
 05-78 20cm



Brophy Dressing Forceps
 Curved Serrated
 05-79 20cm



Brophy Tissue Forceps
 1x2 teeth
 Straight Serrated
 05-80 20cm



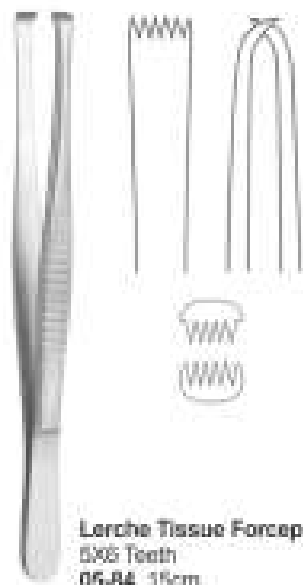
Brophy Tissue Forceps
 1x2 teeth
 Curved Serrated
 05-81 20cm



Wangenstein Dressing Forceps
 05-82 20cm



Stone Tissue Forceps
 4x5 Teeth
 05-83 15.2cm

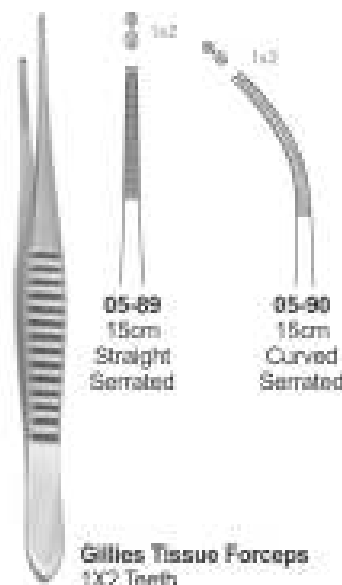


Lerche Tissue Forceps
 5x5 Teeth
 05-84 15cm



05-85 15cm
 05-86 20cm
 05-87 15cm
 05-88 20cm

Adlerkreutz Tissue Forceps



05-89 15cm
 Straight Serrated

05-90 15cm
 Curved Serrated

Gillies Tissue Forceps
 1x2 Teeth



Trovas Tissue Forceps
 1x2 Teeth
 05-91 12.5cm
 05-92 15cm
 05-93 18cm
 Dissecting Forceps
 teeth, on smooth jaws.



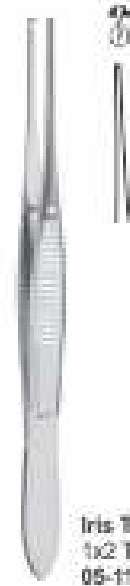
Tissue Forceps
2x3 Teeth
05-94 11.4cm
05-95 13.0cm
05-96 14.5cm
05-97 16.0cm
05-98 17.5cm
05-99 20.0cm
05-100 25.0cm
05-101 30.0cm



Tissue Forceps
3x4 Teeth
05-102 11.4cm
05-103 13.0cm
05-104 14.5cm
05-105 16.0cm
05-106 17.5cm
05-107 20.0cm
05-108 25.0cm
05-109 30.0cm



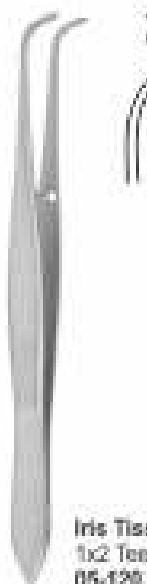
Tissue Forceps
4x5 Teeth
05-110 11.4cm
05-111 13.0cm
05-112 14.5cm
05-113 16.0cm
05-114 17.5cm
05-115 20.0cm
05-116 25.0cm
05-117 30.0cm



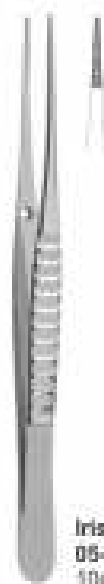
Iris Tissue Forceps
1x2 Teeth, Straight
05-118 10.2 cm



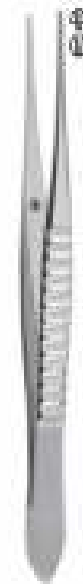
Iris Tissue Forceps
1x2 Teeth, Half Curved
05-119 10.2 cm



Iris Tissue Forceps
1x2 Teeth, Full Curved
05-120 10.2 cm



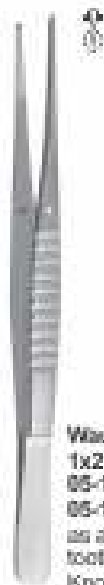
Iris Forceps
05-121
10cm



Iris Tissue Forceps
1x2 Teeth
05-122 10cm



Waugh Dressing Forceps
05-123 15 cm
05-124 18 cm
slightly heavier
non-toothed,
serrated jaws.



Waugh Tissue Forceps
1x2 Teeth
05-125 15 cm
05-126 18 cm
as above but one two
tooth on serrated jaws.
Known as Scott.



Leadham Tissue Forceps
1x2 Teeth
05-127 14.5 cm
05-128 18 cm
Green Dissecting
Forceps two-three
teeth, smooth jaws.

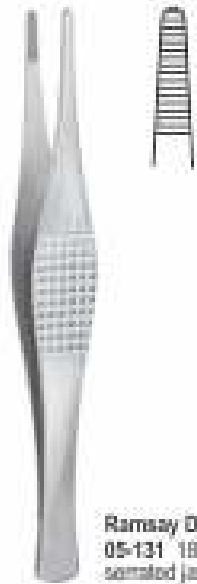


Chamley Tissue Forceps
1x2 Teeth
05-129 14.5cm
05-130 18.0cm
Dissecting Forceps
one into two teeth,
block on jaws.

TISSUE & DRESSING FORCEPS

Pinzas para tejidos, Pincas à dissection
Pinze per tessuti, Pinze per dissezione

Pincas a tissu, Anatomische pinzetten
Geveebe, Pinzas de dissecçion



Ramsay Dissecting Forceps
05-131 18cm
serrated jaws



Ramsay Tissue Forceps
Dissecting Forceps
one into teeth on
serrated jaws.

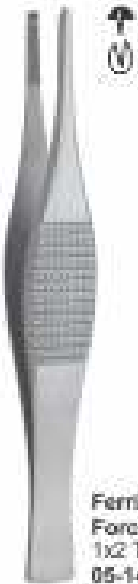
05-132 18cm
1x2 teeth
05-133 18cm
2x3 teeth



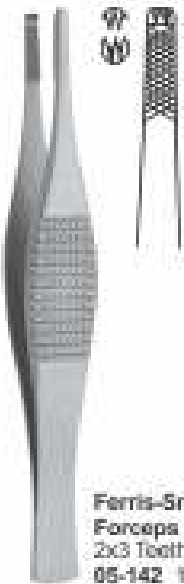
Dissecting Dressing Forceps
05-134 12.5cm
05-135 15.0cm
05-136 18.0cm
turn over end,
serrated jaws.



Dissecting Dressing Forceps
05-137 12.5cm
05-138 15.0cm
05-139 18.0cm
05-140 20.0cm
block end, serrated
jaws.



Ferris-Smith Tissue Forceps
1x2 Teeth
05-141 18cm



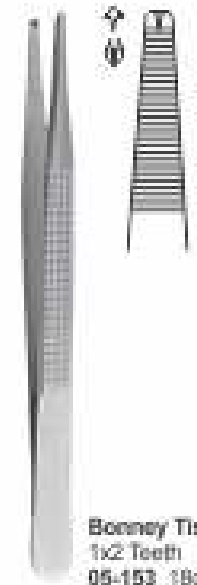
Ferris-Smith Tissue Forceps
2x3 Teeth
05-142 18cm



Lane Tissue Forceps
1x2 Teeth
05-143 12.5cm
05-144 15cm
05-145 17cm
05-146 18cm
05-147 20cm



Lane Tissue Forceps
2x3 Teeth
05-148 12.5cm
05-149 15cm
05-150 17cm
05-151 18cm
05-152 20cm



Bonney Tissue Forceps
1x2 Teeth
05-153 18cm



Bonney Tissue Forceps
2x3 Teeth
05-154 18cm



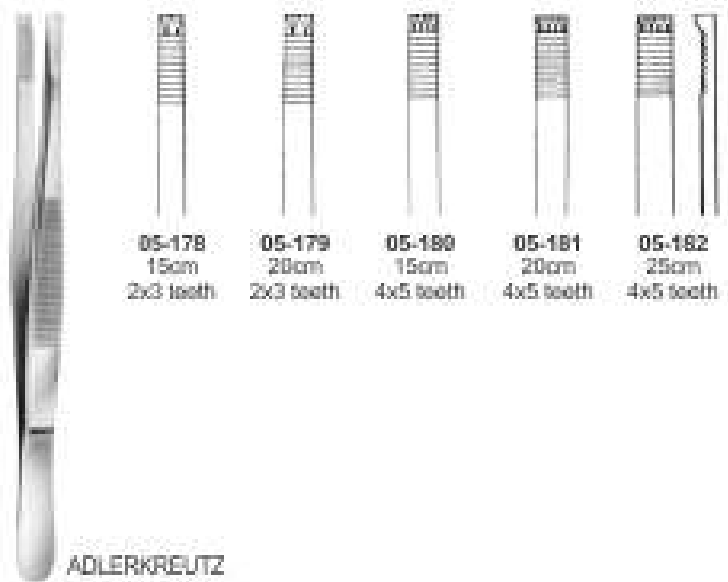
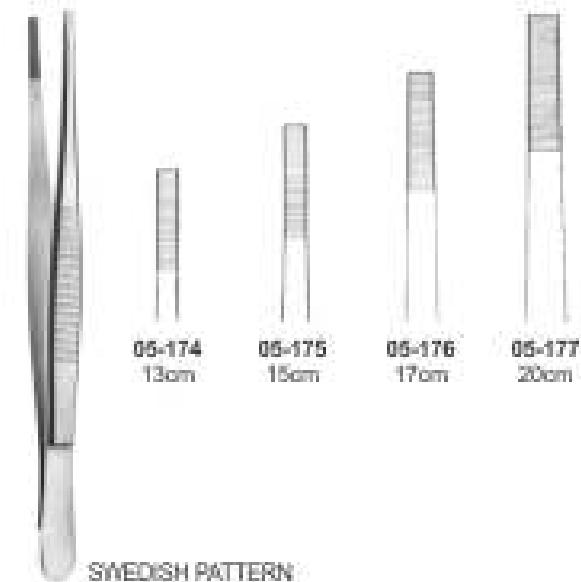
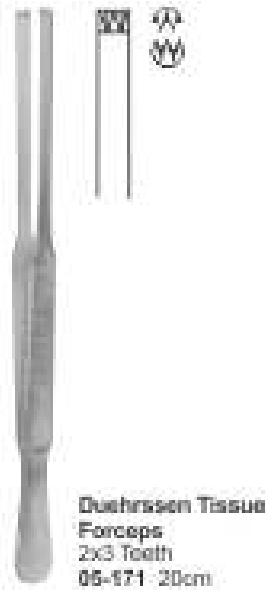
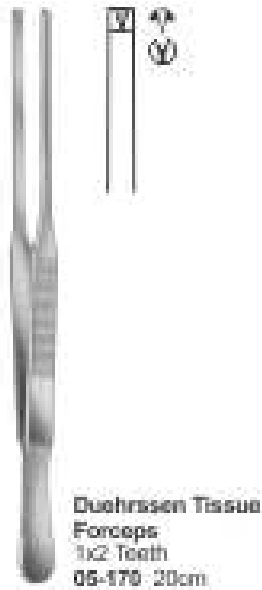
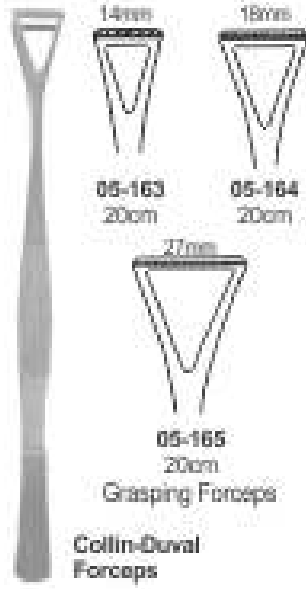
Durante Tissue Grasping Forceps
05-155 14.5cm
05-156 16cm
05-157 20cm



Nelson Tissue Forceps
05-158 23cm
6x7 Teeth

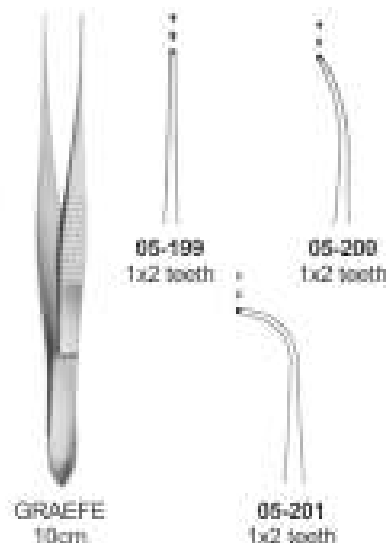
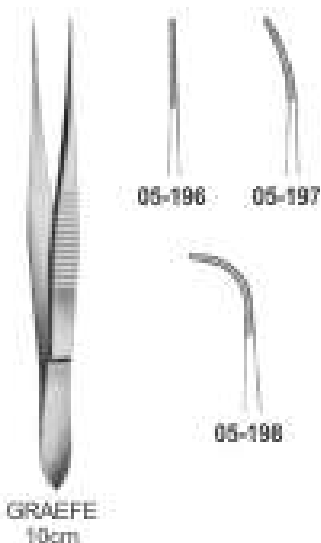
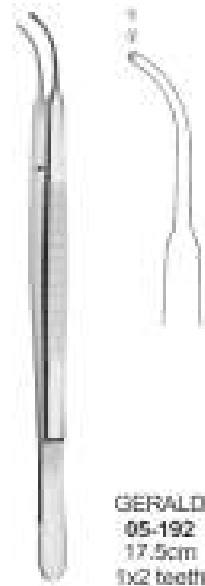
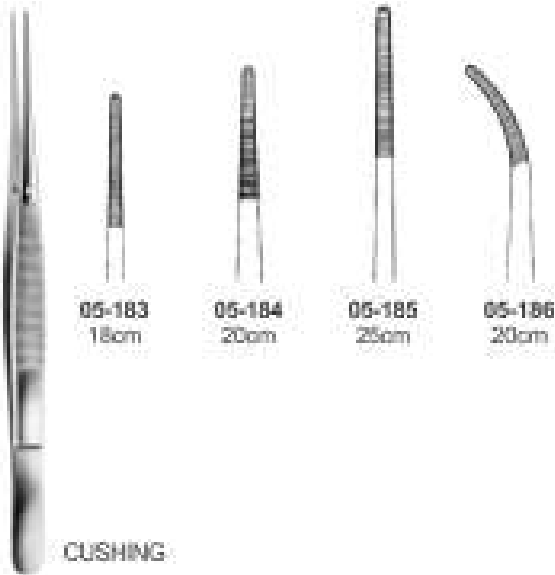
Pinzas para tejidos, Pinzas à dissection | Pinzas a tissu, Anatomische pinzetten
Pinze per tessuti, Pinze per dissezione |

Pinzas a tissu, Anatomische pinzetten
Gewebe, Pinzas de dissección



TISSUE & DRESSING FORCEPS

Pinzas para tejidos, Pinzas à dissection | *Pinzas a tissu, Anatomische pinzetten*
Pinze per tessuti, Pinze per dissezione | *Geveebe, Pinzas de dissecçào*

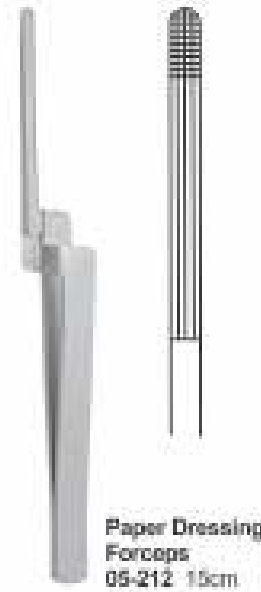
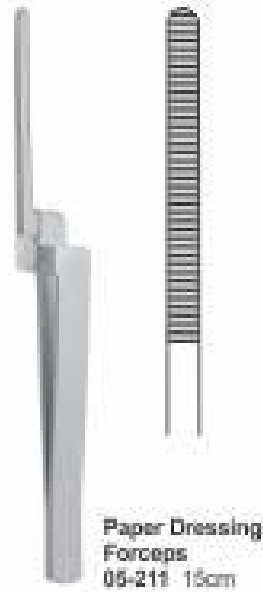


Pinzas para tejidos, Pinces à dissection
Pinze per tessuti, Pinze per dissezione

Pinces a tissu, Anatomische pinzetten
Gewebe, Pinzas de disecccion



05-208
14cm
05-209
16cm
05-210
20cm
Dressing,
Serrated



5mm hole



3 mm

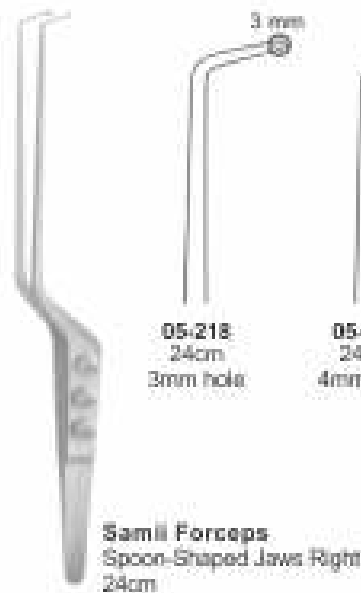
05-215
24cm
3mm hole

4 mm

05-216
24cm
4mm hole

5 mm

05-217
24cm
5mm hole



3 mm

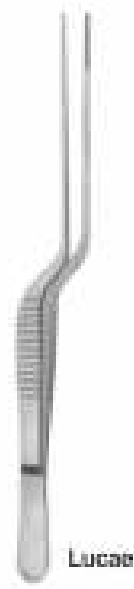
05-218
24cm
3mm hole

4 mm

05-219
24cm
4mm hole

5 mm

05-220
24cm
5mm hole



05-222
14cm
05-223
16cm
05-224
18cm
05-225
20cm
Dressing
Serrated



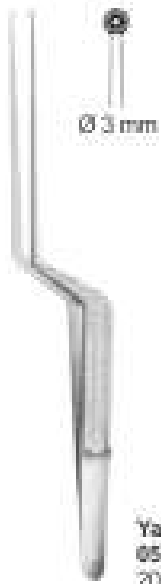
1x2 tooth
05-226
14cm
05-227
16cm
05-228
18cm
05-229
20cm



TISSUE & DRESSING FORCEPS

Pinzas para tejidos, Pincas à dissection
Pinze per tessuti, Pinze per dissezione

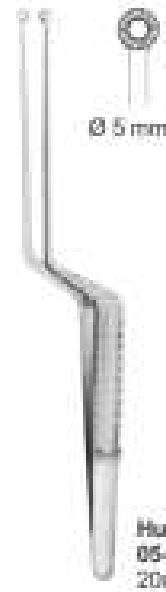
Pincas a tissu, Anatomische pinzetten
Geewebe, Pinzas de disecçidn



Yasargil
05-231
20cm



Hunt
05-232
20cm



Hunt
05-233
20cm



Plain Forceps
05-234 18.5cm



Jansen
05-235 16 cm
05-236 18 cm
05-237 20 cm



Plain Forceps
05-238 16cm



Tissue Forceps
05-239 16cm



Gruenwald Forceps
05-240 14cm
05-241 20cm



Gruenwald Tissue Forceps
05-242 20cm



Hoen
05-243
20cm



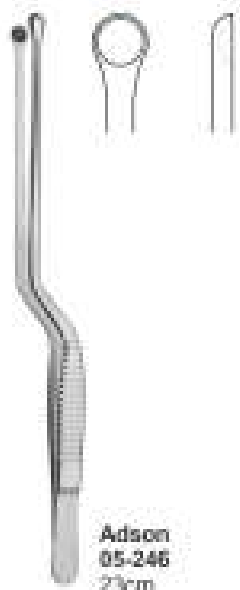
D'Errico
05-244
22cm



D'Errico
05-245
22cm

Pinzas para tejidos, Pinces à dissection
 Pinze per tessuti, Pinze per dissezione

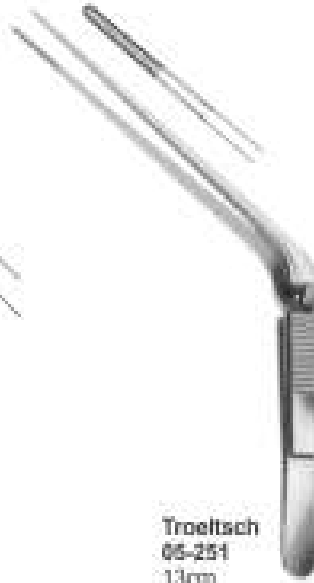
Pinces a tissu, Anatomische pinzetten
 Gewebe, Pinzas de disecccion



Adson
 05-246
 23cm



Troeltsch
 05-247 10cm
 05-248 12cm
 05-249 15cm
 05-250 17cm



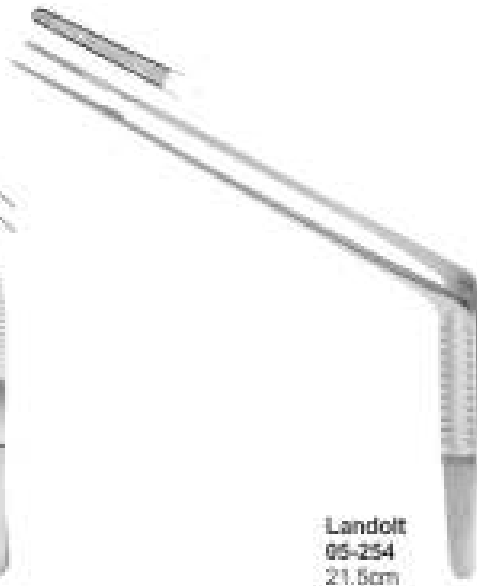
Troeltsch
 05-251
 13cm



Wilde
 05-252
 11cm



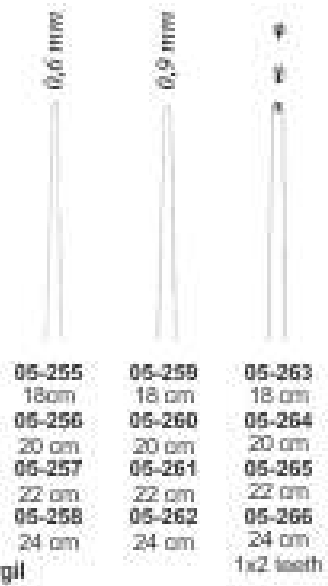
Troeltsch
 05-253
 11.5cm



Landolt
 05-254
 21.5cm



Yasargil



05-255 18cm	05-259 18 cm	05-263 18 cm
05-256 20 cm	05-260 20 cm	05-264 20 cm
05-257 22 cm	05-261 22 cm	05-265 22 cm
05-258 24 cm	05-262 24 cm	05-266 24 cm

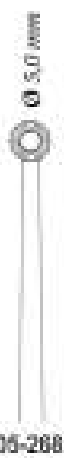
1x2 teeth



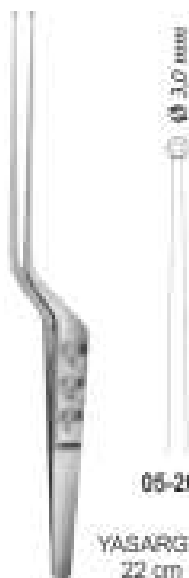
YASARGIL
 22 cm



05-267



05-268



YASARGIL
 22 cm



05-269



05-270



YASARGIL
 24 cm



05-271



05-272

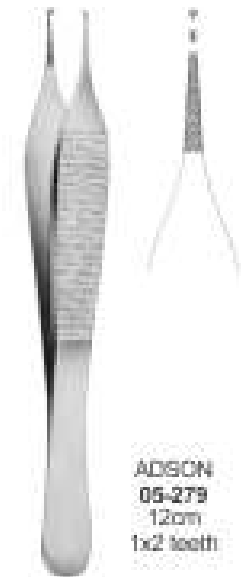


05-273

TISSUE & DRESSING FORCEPS

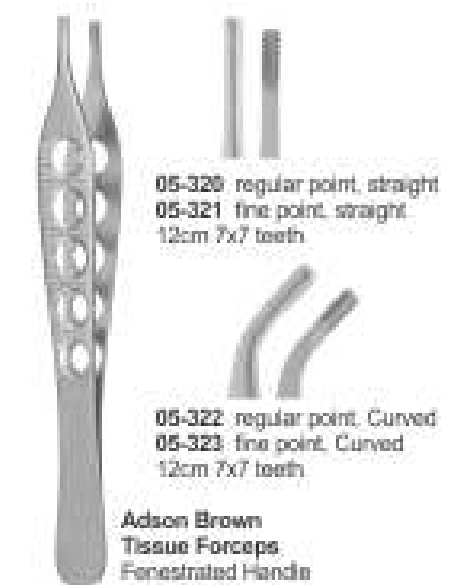
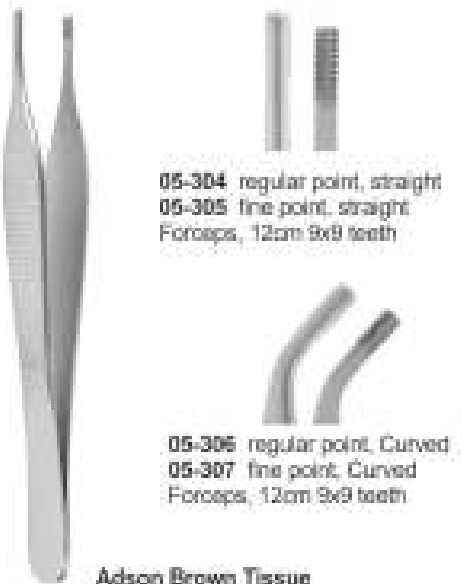
Pincas a tissu, Anatomische pinzetten
Geewebe, Pinzas de disección

Pincas para tejidos, Pincas à dissection
Pinze per tessuti, Pinze per dissezione



Pinces a tissu, Anatomische pinzetten
Gewebe, Pinzas de disección

Pinzas para tejidos, Pinces à dissection
Pinze per tessuti, Pinze per dissezione



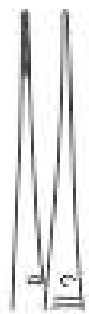
TISSUE & DRESSING FORCEPS

Pinces a tissu, Anatomische pinzetten
Geuebe, Pinzas de disección

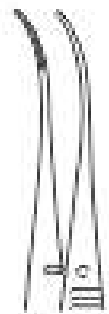
Pinzas para tejidos, Pince à dissection
Pinze per tessuti, Pinze per dissezione



Graefe Forceps



05-324
7cm
05-325
10cm
straight
serrated



05-326
7cm
05-327
10cm
half curved
serrated



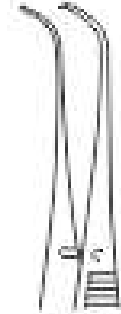
05-328
7cm
05-329
10cm
full curved
serrated



05-330
7cm
05-331
10cm
1x2 teeth
straight



05-332
7cm
05-333
10cm
1x2 teeth
half curved



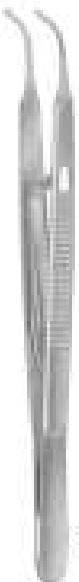
05-334
7cm
05-335
10cm
1x2 teeth
full curved



Stevens Tissue Forceps
1x2 Teeth



05-336
11cm
straight



Stevens Tissue Forceps
1x2 Teeth



05-337
11cm
Curved



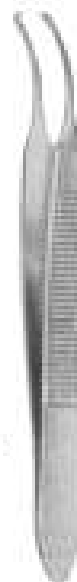
Graefe Dressing Forceps
05-338 0.5 mm
05-339 0.7 mm
05-340 1.0 mm
7cm
Straight Serrated



Graefe Dressing Forceps
05-341 0.5 mm
05-342 0.7 mm
05-343 1.0 mm
7cm
curved serrated



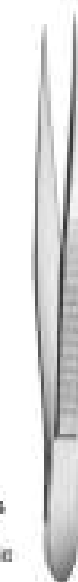
Graefe Tissue Forceps
1x2 Teeth
05-344 0.5 mm
05-345 0.7 mm
05-346 1.0 mm
7cm Straight



Graefe Tissue Forceps
1x2 Teeth
05-347 0.5 mm
05-348 0.7 mm
05-349 1.0 mm
7cm Curved



Graefe Fixation Forceps
05-350 11.2 cm
standard jaws 4.5mm wide
with fine teeth



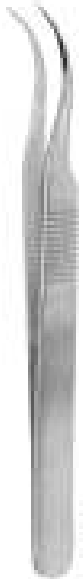
05-351
90mm
05-352
105mm
05-353
115mm
05-354
125mm

Chirurgische pinzetten, Uhrmacher-Pinzetten

Pinces à dissection à griffes, Pinces d'horloger

Pinzas de disección con dientes, Pinzas de relojero

Pinze per dissezione con denti, Pinze de orologiaio



Dumont Forceps
05-355 11.5cm
curved



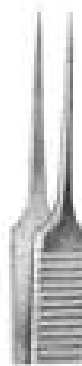
05-356
10.5cm
full curved



05-357
10.5cm
half curved



05-358
11cm



05-359
11cm
fine point



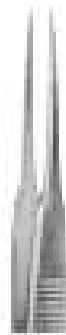
05-360
11cm
extra fine
point



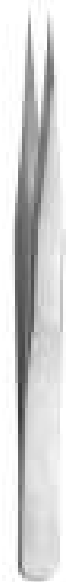
05-361
12cm
fine point



05-362
12cm
extra fine
point



05-363
12cm



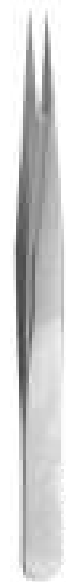
Dumont Forceps
05-364
style 1, fine point,
12cm



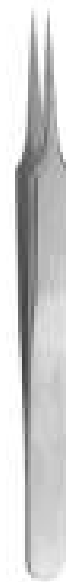
Dumont Forceps
05-365
style 2, strong
fine point,
12cm



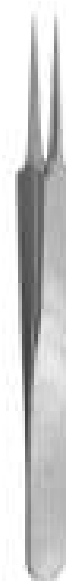
Dumont Forceps
05-366
style 3, narrow
fine point,
12cm



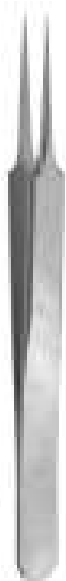
Dumont Forceps
05-367
style 3C, narrow
fine point,
11cm



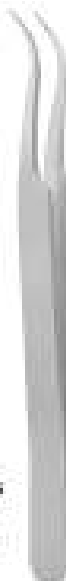
Dumont Forceps
05-368
style 4, fine point,
11cm



Dumont Forceps
05-369
style 5, super fine
11cm point



Dumont Forceps
05-370
style 5, micro fine
11cm point



Dumont Forceps
05-371
style 7, micro fine
11.5 cm curved



Dumont Forceps
05-372
style 7, fine curved,
11.5 cm

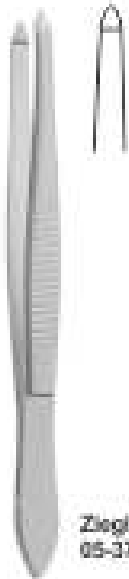


Dumont Forceps
05-373
style 6, pick up,
11.5 cm

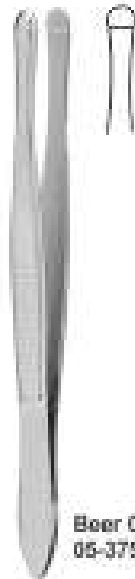
CILIA FORCEPS

Cilienpinzetten
Pinzas depilatorias

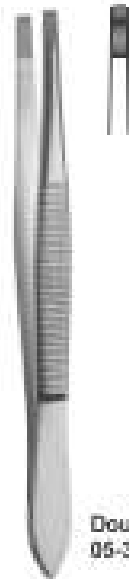
Pinces à épiler les cils
Pinze depilatoria



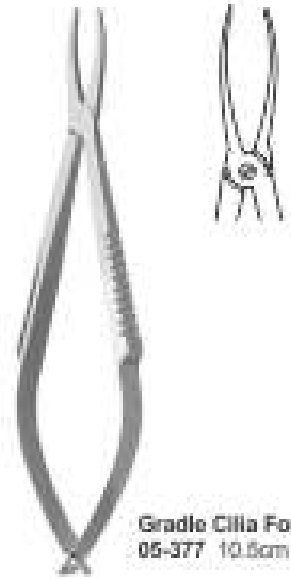
Ziegler Cilia Forceps
05-374 9cm



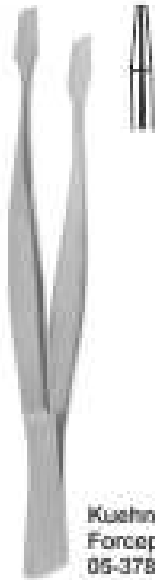
Beer Cilia Forceps
05-375 9cm



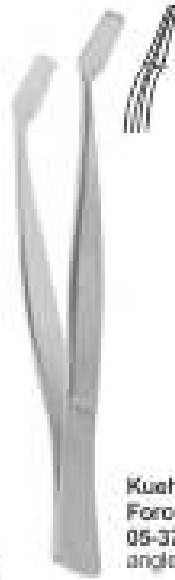
Douglas Cilia Forceps
05-376 9cm



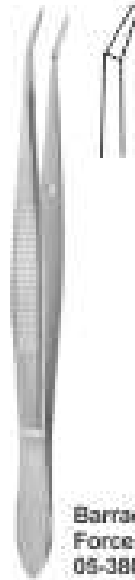
Gradle Cilia Forceps
05-377 10.5cm



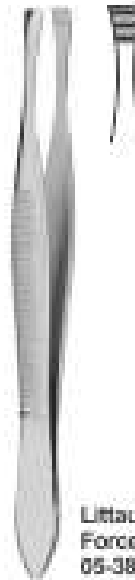
Kuehne Cilia Forceps
05-378 10.5cm



Kuehne Cilia Forceps
05-379 10.5cm
angled sideways



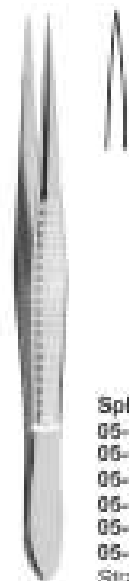
Barraquer Cilia Forceps
05-380 10.5cm



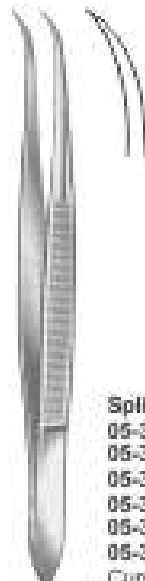
Littauer Cilia Forceps
05-381 8.5cm



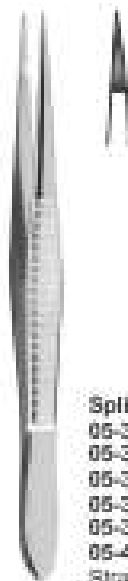
Littauer Cilia Forceps
05-382 9cm



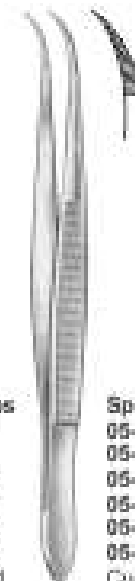
Splinter Forceps
05-383 8 cm
05-384 9 cm
05-385 10.5cm
05-386 11.5cm
05-387 12.5cm
05-388 14.5cm
Straight Plain



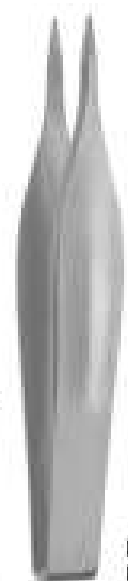
Splinter Forceps
05-389 8cm
05-390 9cm
05-391 10.5cm
05-392 11.5cm
05-393 12.5cm
05-394 14.5cm
Curved Plain



Splinter Forceps
05-395 8cm
05-396 9cm
05-397 10.5cm
05-398 11.5cm
05-399 12.5cm
05-400 14.5cm
Straight serrated



Splinter Forceps
05-401 8cm
05-402 9cm
05-403 10.5cm
05-404 11.5cm
05-405 12.5cm
05-406 14.5cm
Curved serrated

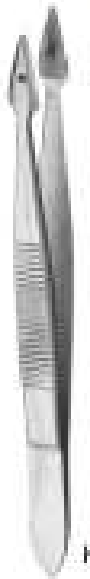


05-407 7.5cm
05-408 9cm
05-409 11cm
Straight

Felchenfeld Forceps

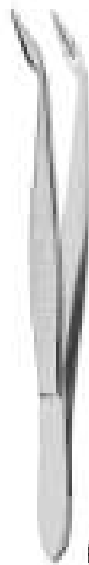
SPLINTER FORCEPS

Splitterpinzetten | Pincas à échardes
Pinças Para espinas | Pinze per scheggie



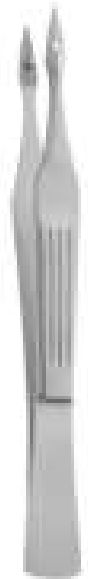
05-410
10.5cm
Straight

Hunter Forceps



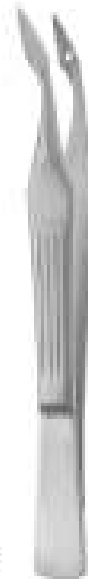
05-411
10.5cm
Curved

Hunter Forceps



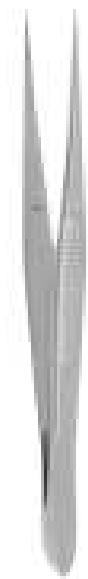
05-412
10.5cm
Straight

Carmalt Forceps

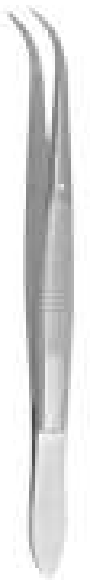


05-413
10.5cm
Curved

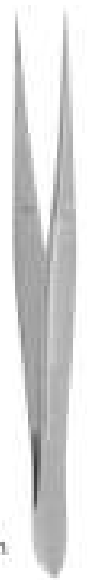
Carmalt Forceps



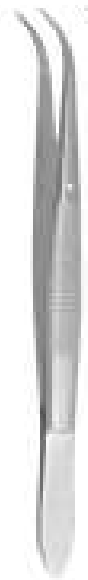
Splinter Forceps
05-414 8cm
05-415 9cm
05-416 10.5cm
05-417 11.5cm
05-418 12.5cm
05-419 14.5cm
Straight serrated
with guide pin



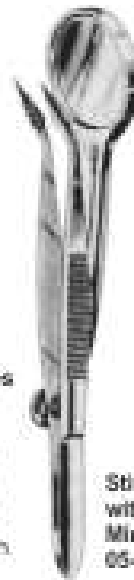
Splinter Forceps
05-420 8cm
05-421 9cm
05-422 10.5cm
05-423 11.5cm
05-424 12.5cm
05-425 14.5cm
Curved serrated with
guide pin



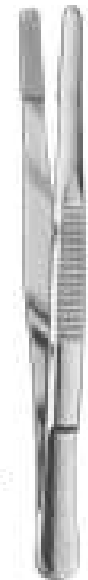
Splinter Forceps
05-426 8cm
05-427 9cm
05-428 10.5cm
05-429 11.5cm
05-430 12.5cm
05-431 14.5cm
Straight plain with
guide pin



Splinter Forceps
05-432 8cm
05-433 9cm
05-434 10.5cm
05-435 11.5cm
05-436 12.5cm
05-437 14.5cm
Curved plain with
guide pin



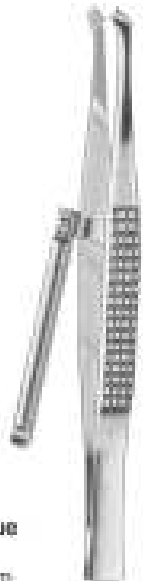
**Stieglitz Forceps
with Magnifying
Mirrors**
05-438 12.5cm



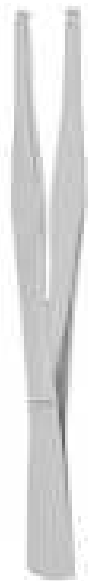
Ochsner Forceps
05-439 14cm



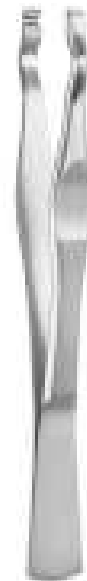
**Lange Tissue
Forceps**
05-440 10cm



**Childe Tissue
Forceps**
05-441 18cm



**Michel Tissue
Forceps**
05-442 12cm



**Wachenfeldt
Tissue Forceps**
05-443 12.5cm



**Hegenbarth
Tissue Forceps**
05-444 12.5cm

SPLINTER FORCEPS

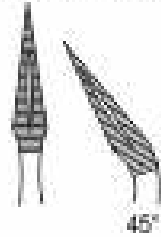
Splittterpinzetten | *Pinces à échardes*
Pinças Para espinas | *Pinze per scheggie*



**Wachenfeldt
Tissue Forceps**
05-445 12.5cm



Stieglitz Splinter Forceps
05-446 14cm Str.
05-447 14cm 45° Angled



45°

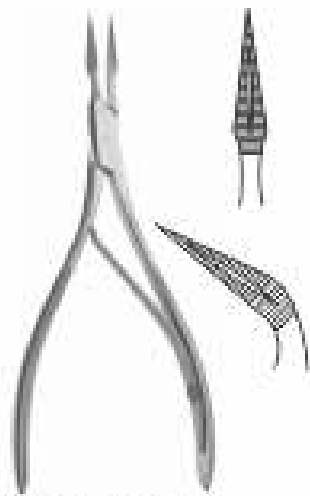


Stieglitz Splinter Forceps
05-448 14cm, 90° Angled

90°



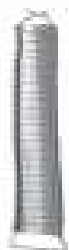
Peet Splinter Forceps
05-449 15.5cm



Raik Splinter Forceps
05-450 15cm, Str.
05-451 15cm, Cvd.



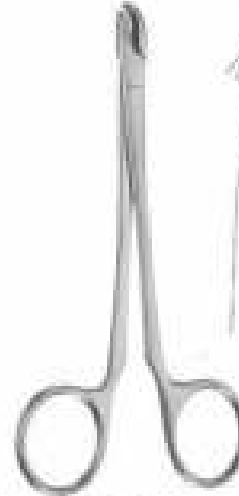
Michel Forceps
05-452 12cm



Michel Clips
05-453
sizes: 11mm x 3mm
& 18mm x 3mm.



Mod. Michel Forceps
05-454 12cm



Collin Forceps
05-455 13cm



Richter-Heath Forceps
05-456 14cm



1.5 mm

05-457
14cm

3.0 mm

05-460
20cm

T.C. Dehler Tissue Forceps



2.0 mm

05-458
16cm

3.7 mm

05-461
25cm



2.7 mm

05-459
18cm

4.0 mm

05-462
30cm



0.4 mm

05-463
15cm

**Semken
with dissector
end**



0.2 mm

05-464
16cm

0.2 mm

05-465
18cm

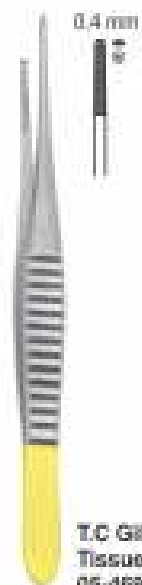
**Semken
1x2 teeth**



1.5 mm

2.0 mm

**T.C. De Bakay
Dressing Forceps**
05-466 15cm
05-467 19cm
05-468 24cm

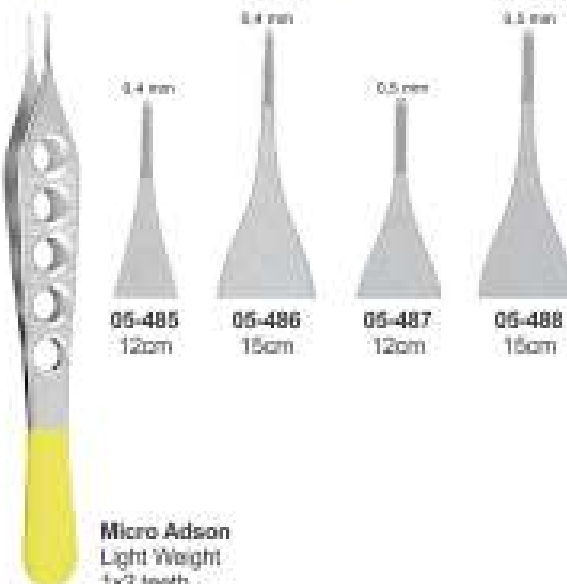


0.4 mm

**T.C. Gilles
Tissue Forceps**
05-469 15cm

Pincas a tissu, Anatomische pinzetten
Gewebe, Pinzas de diseccion

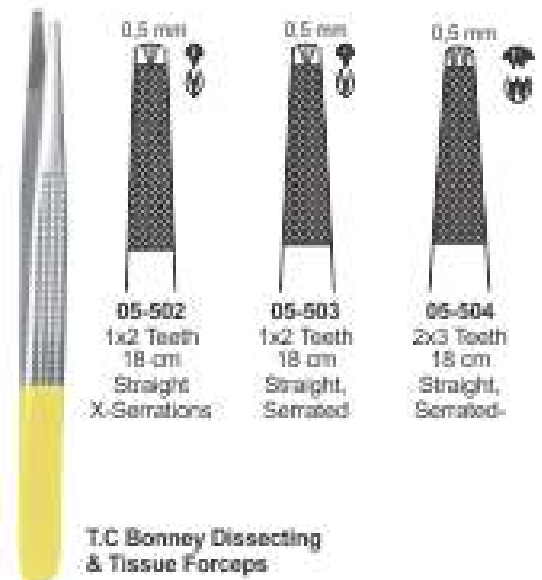
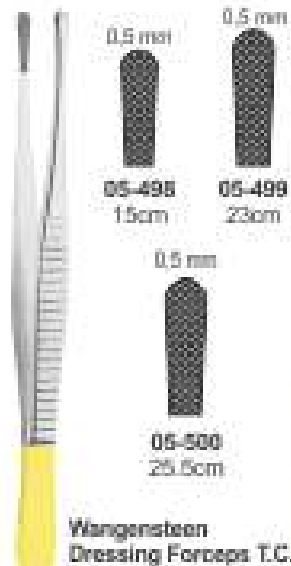
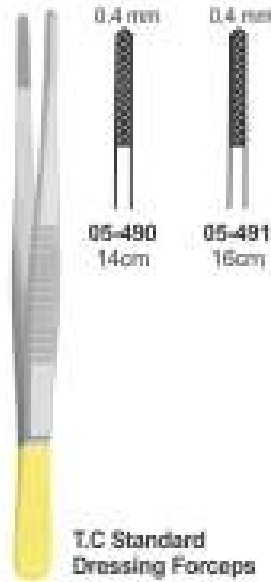
Pinzas para teidos, Pincas à dissection
Pinze per tessuti, Pinze per dissezione



TISSUE & DRESSING FORCEPS T.C

Pincas a tissu, Anatomische pinzetten
Geuebe, Pinzas de disección

Pinzas para tejidos, Pincas à dissection
Pinze per tessuti, Pinze per dissezione



HAEMOSTATIC FORCEPS



HAEMOSTATIC FORCEPS

Arterienklemmen

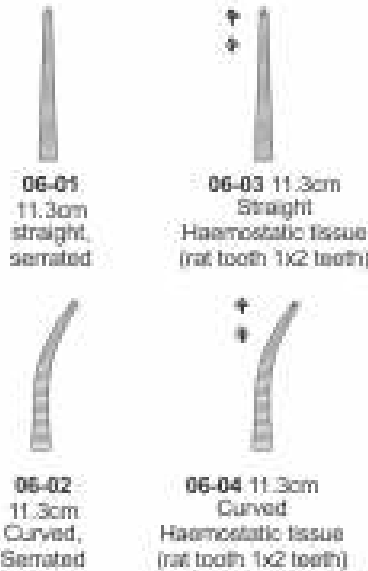
Pinças Hemostáticas

Pinces Hemostatiques

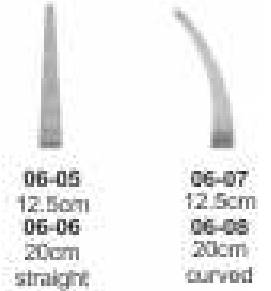
Pinze Emostatiche



Mosquito Haemostatic Forceps



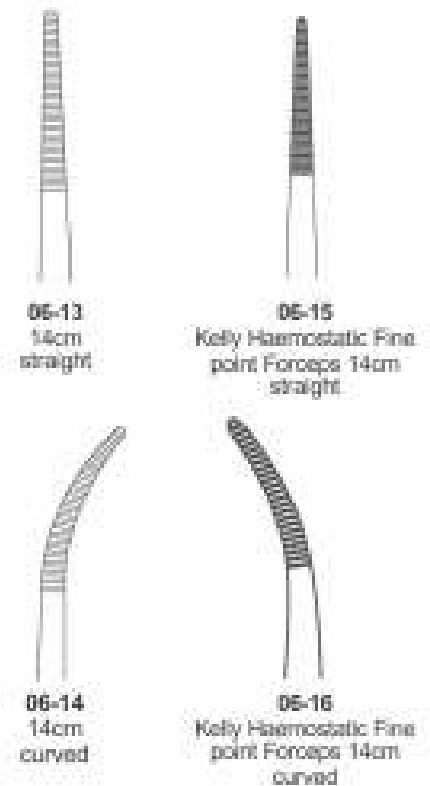
Halsted-Mosquito
Haemostatic Forceps



Halsted-Mosquito
Haemostatic Forceps



Kelly Haemostatic Forceps



HAEMOSTATIC FORCEPS

Arterienklemmen
Pinces Hemostatiques

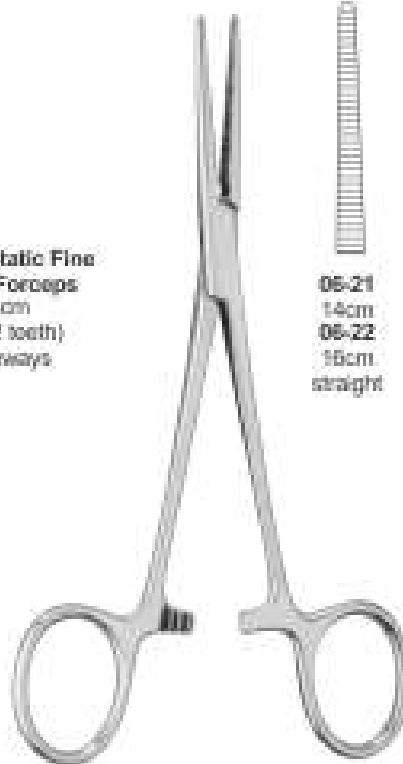
Pinzas Hemostaticas
Pinze Emostatiche



Dandy Haemostatic Fine point Forceps
06-18 14cm
Curved sideways



Dandy Haemostatic Fine point Tissue Forceps
06-20 14cm
(rat tooth 1x2 tooth)
Curved sideways



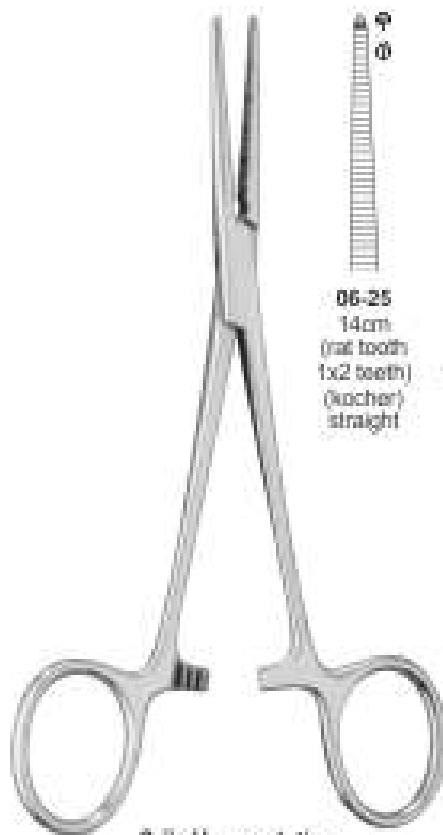
06-21 14cm
06-22 16cm
straight

06-23 14cm
06-24 16cm
curved

Dandy Haemostatic Forceps
06-17 14cm
Curved sideways

Dandy Haemostatic Tissue Forceps
06-19 14cm
(rat tooth 1x2 tooth)
Curved sideways

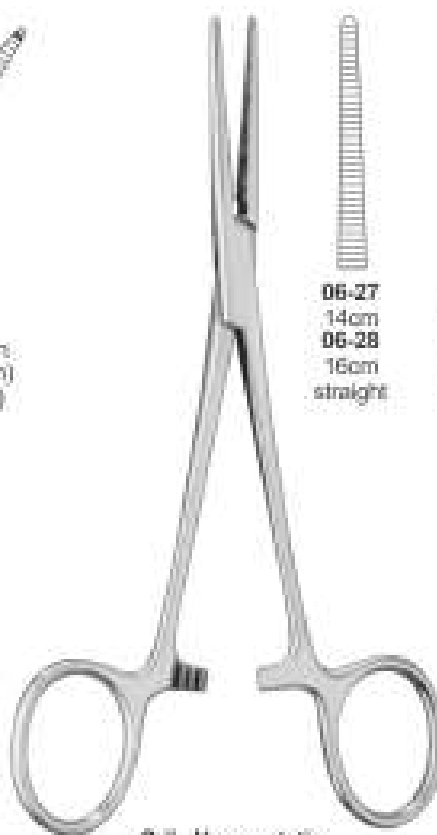
Crile Haemostatic Forceps



06-25 14cm
(rat tooth 1x2 tooth)
(kocher) straight

06-26 14cm
(rat tooth 1x2 tooth)
(kocher) curved

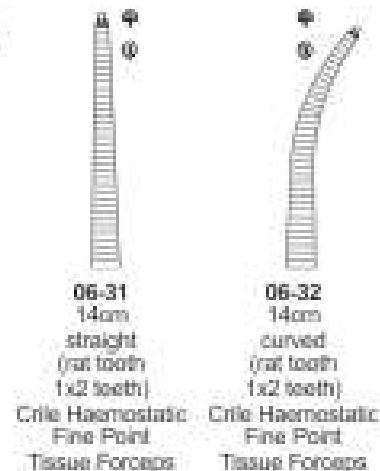
Crile Haemostatic Tissue Forceps



06-27 14cm
06-28 16cm
straight

06-29 14cm
06-30 16cm
curved

Crile Haemostatic Fine Point Forceps



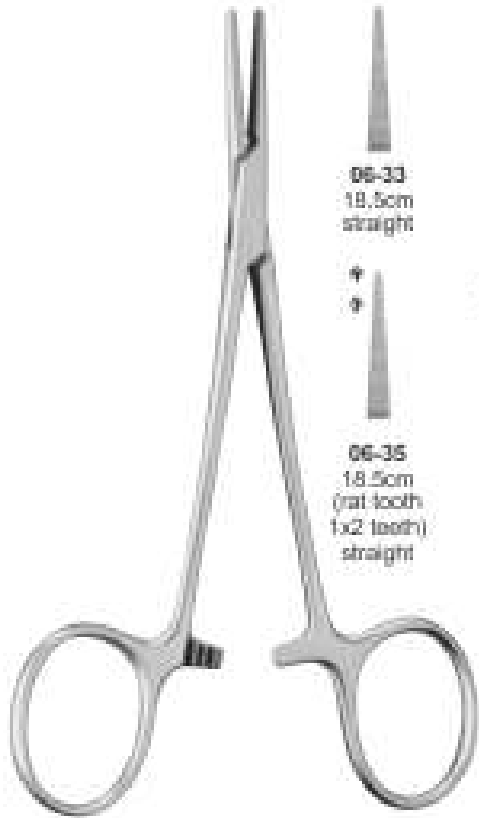
06-31 14cm
straight
(rat tooth 1x2 tooth)
Crile Haemostatic Fine Point Tissue Forceps

06-32 14cm
curved
(rat tooth 1x2 tooth)
Crile Haemostatic Fine Point Tissue Forceps

HAEMOSTATIC FORCEPS

Arterienklemmen
Pincas Hemostatiques

Pinças Hemostáticas
Pinze Emostatiche



06-33
18.5cm
straight



06-35
18.5cm
(rat tooth
1x2 teeth)
straight

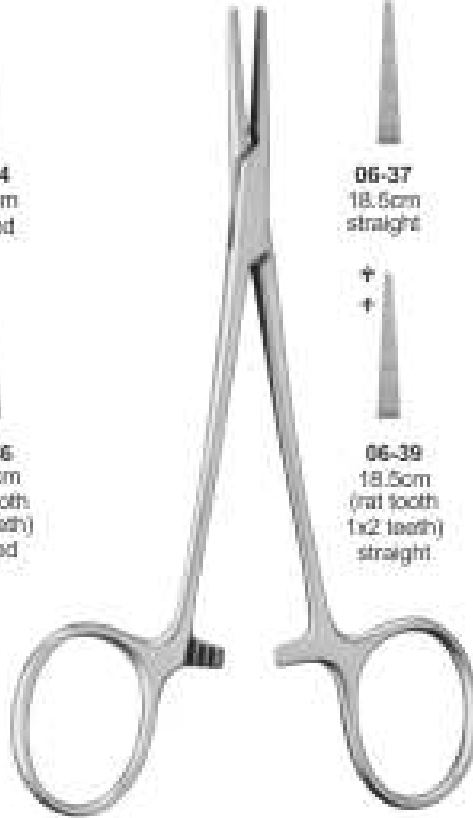


06-34
18.5cm
curved



06-36
18.5cm
(rat tooth
1x2 teeth)
curved

Halsted Haemostatic Forceps



06-37
18.5cm
straight



06-39
18.5cm
(rat tooth
1x2 teeth)
straight



06-38
18.5cm
curved

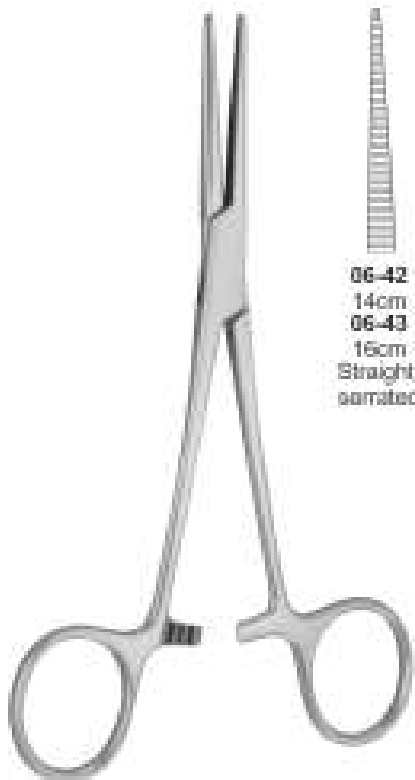


06-40
18.5cm
(rat tooth
1x2 teeth)
curved

Halsted Haemostatic
Fine point Forceps



Packer Mosquito Forceps
06-41 12.7cm
Curved, flat jaws

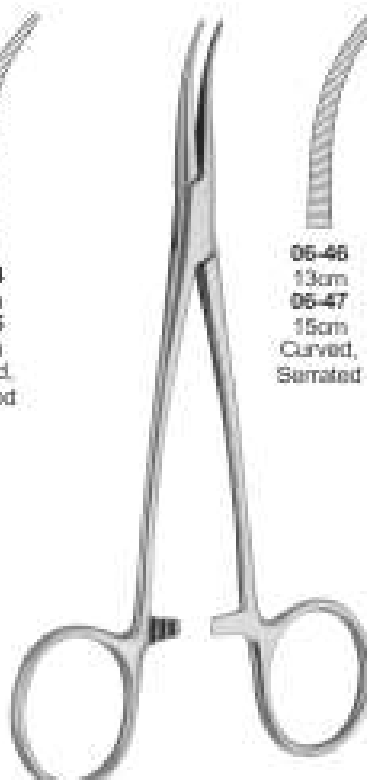


06-42
14cm
06-43
16cm
Straight,
serrated



06-44
14cm
06-45
16cm
Curved,
serrated

Coller Haemostatic Forceps

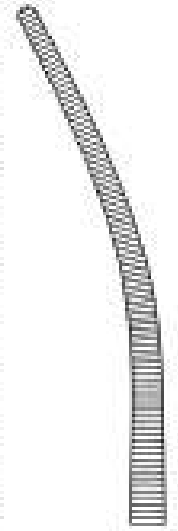


06-46
13cm
06-47
15cm
Curved,
Serrated

Christophe Haemostatic Forceps



06-48
24cm
Straight,
Serrated



06-49
24cm
Curved
Serrated

Saroot Haemostatic
Forceps

Arterienklemmen
Pinces Hemostatiques

Pinzas Hemostaticas
Pinze Emostatiche



06-50
18.5cm
straight

06-51
18.5cm
curved

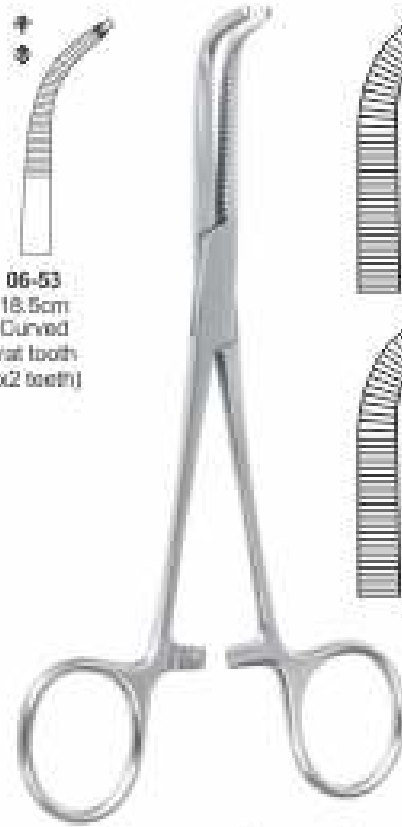
Adson Haemostatic Fine point Forceps



06-52
18.5cm
straight
(rat tooth
1x2 teeth)

06-53
18.5cm
Curved
(rat tooth
1x2 teeth)

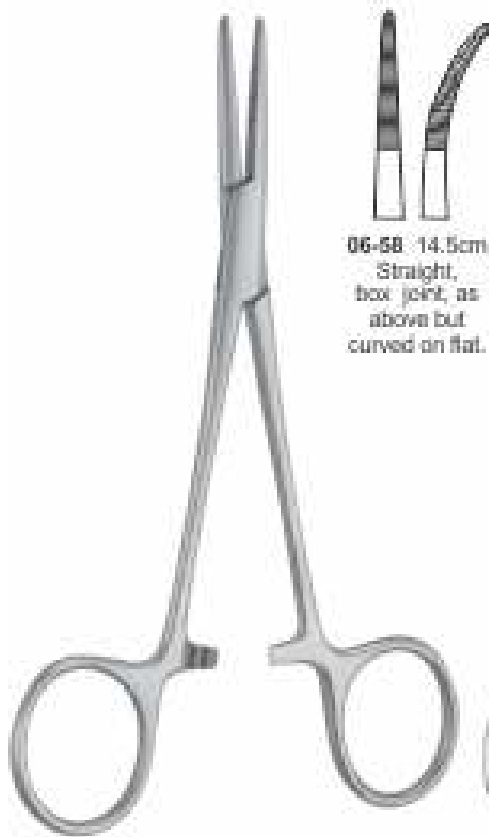
Adson Haemostatic Tissue Forceps



06-54
15cm
Curved

06-56
15cm
06-57
20cm
Curved
Fine Point

O'Shaughnessy Haemostatic Forceps



06-58 14.5cm
Straight,
bow joint, as
above but
curved on flat.

Cairns Haemostatic Forceps



06-59
13cm
06-60
14cm
straight

06-61
13cm
06-62
14cm
curved

Pean Haemostatic Forceps Slender Type



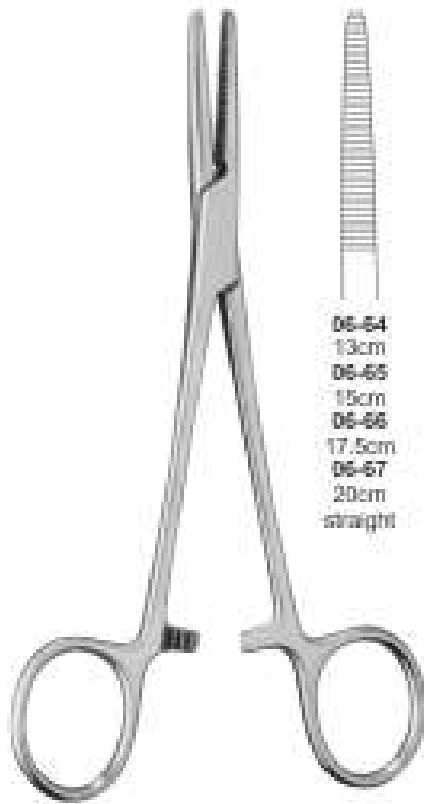
06-63
14.5cm
Straight

Kocher Haemostatic Forceps Strong Pattern

HAEMOSTATIC FORCEPS

Arterienklemmen
Pinces Hemostatiques

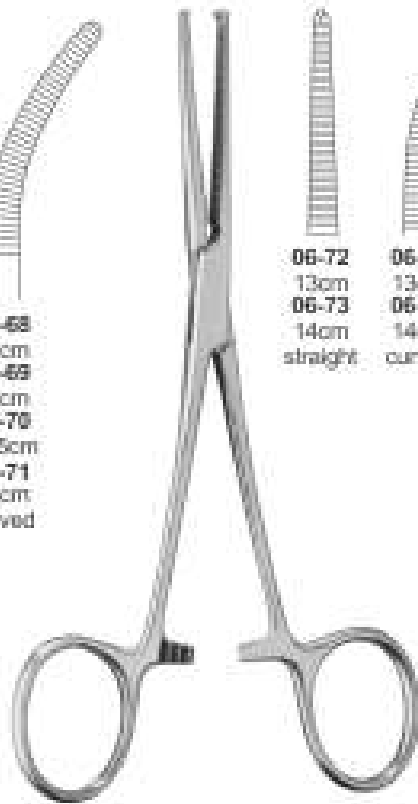
Pinzas Hemostaticas
Pinze Emostatiche



06-64
13cm
06-65
15cm
06-66
17.5cm
06-67
20cm
straight

06-68
13cm
06-69
15cm
06-70
17.5cm
06-71
20cm
curved

Spencer-Wells Haemostatic Forceps
Slender Type



06-72
13cm
06-73
14cm
straight

06-74
13cm
06-75
14cm
curved

Kocher Haemostatic Forceps
1x2 teeth



06-76
16cm
06-77
20cm
Straight

06-78
16cm
06-79
20cm
Curved

Rochester-Carmalt Haemostatic
Forceps

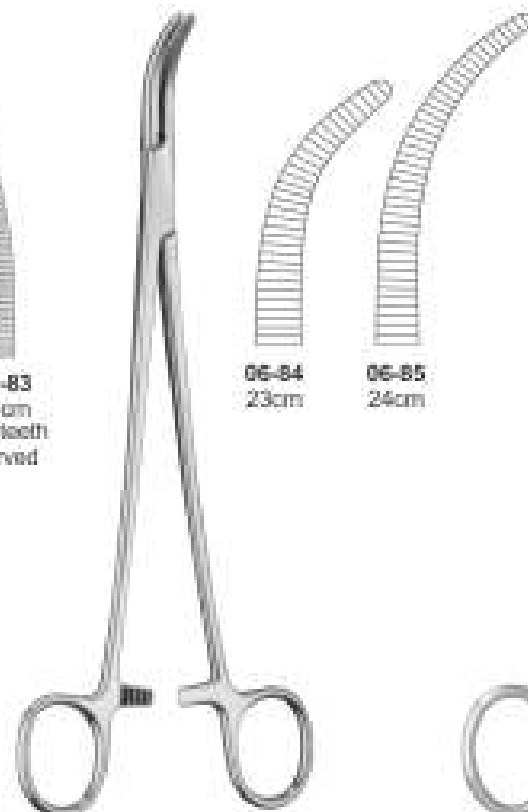


06-80
16cm
06-81
20cm
Straight

06-82
14cm
1x2 teeth
Straight

06-83
14cm
1x2 teeth
Curved

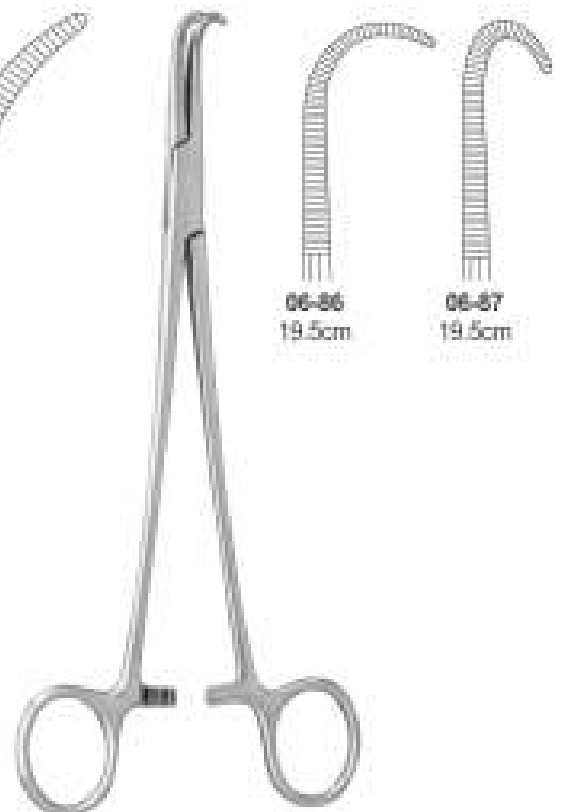
Rochester-Dohsner
Haemostatic Forceps



06-84
23cm

06-85
24cm

Moynihan Haemostatic Forceps



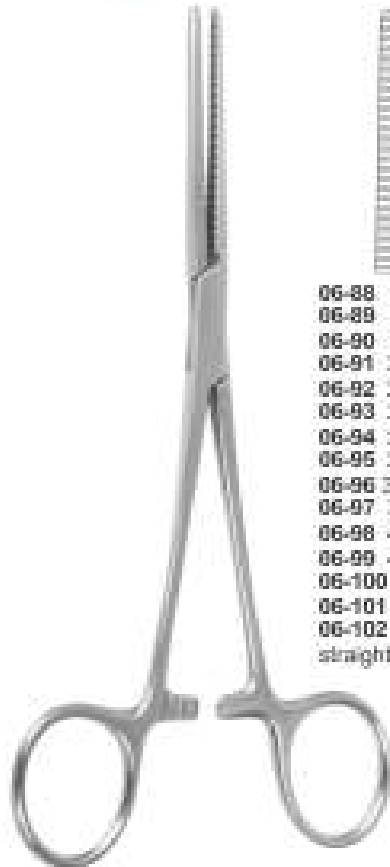
06-86
19.5cm

06-87
19.5cm

Negus Haemostatic Forceps

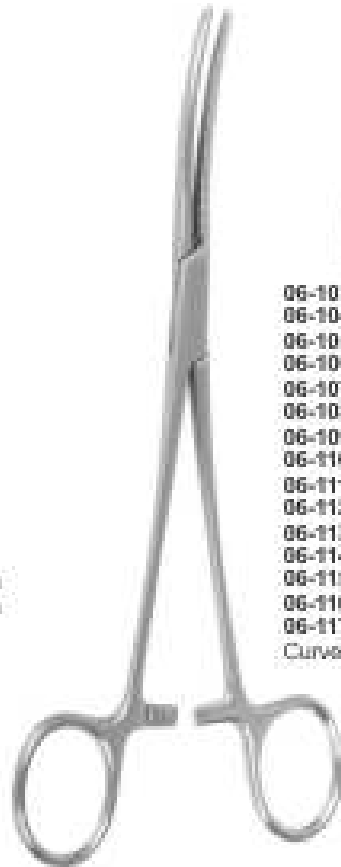
Arterienklemmen
Pincas Hemostatiques

Pinças Hemostáticas
Pinze Emastatiche



- 06-88 14cm
- 06-89 16cm
- 06-90 18.5cm
- 06-91 20cm
- 06-92 22.5cm
- 06-93 24cm
- 06-94 25.4cm
- 06-95 28cm
- 06-96 30.5cm
- 06-97 35.8cm
- 06-98 40.5cm
- 06-99 45.5cm
- 06-100 50.8cm
- 06-101 55.5cm
- 06-102 60cm
straight

Rochester-Pean Haemostatic Forceps
Straight



- 06-103 14cm
- 06-104 16cm
- 06-105 18.5cm
- 06-106 20cm
- 06-107 22.5cm
- 06-108 24cm
- 06-109 25.4cm
- 06-110 28cm
- 06-111 30.5cm
- 06-112 35.6cm
- 06-113 40.5cm
- 06-114 45.5cm
- 06-115 50.8cm
- 06-116 55.6cm
- 06-117 60cm
Curved

Rochester-Pean Haemostatic
Forceps Curved



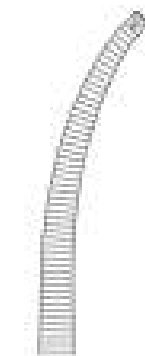
- 06-118
18.5cm
1x2 teeth

Mikulicz Haemostatic Tissue Forceps



- 06-119 16cm
- 06-120 18.5cm
- 06-121 20cm
- 06-122 22.5cm
- 06-123 24cm
- 06-124 26cm
Straight
1x2 teeth

Kocher-Ochsner Haemostatic
Forceps 1x2 teeth



- 06-125 16cm
- 06-126 18.5cm
- 06-127 20cm
- 06-128 22.5cm
- 06-129 24cm
- 06-130 26cm
Curved
1x2 teeth

Rochester-Ochsner
Haemostatic Forceps
1x2 teeth



- 06-131 14cm
- 06-132 15cm
- 06-133 16cm
- 06-134 18cm
- 06-135 20cm
- 06-136 22cm
- 06-137 24cm
- 06-138 26cm
- 06-139 28cm
- 06-140 25cm
- 06-141 14cm
- 06-142 15cm
- 06-143 16cm
- 06-144 18cm
- 06-145 20cm
- 06-146 22cm
- 06-147 24cm
- 06-148 26cm
- 06-149 28cm
- 06-150 25cm

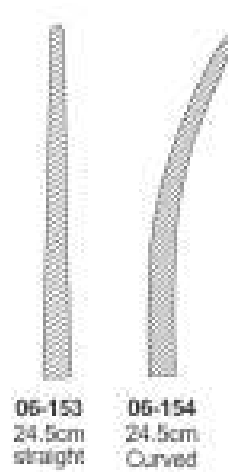
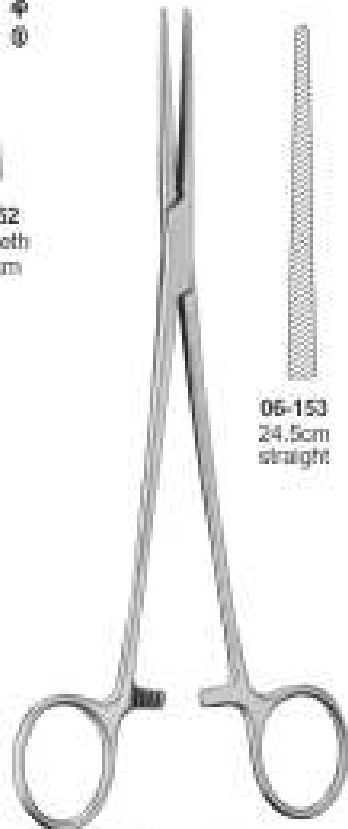
HAEMOSTATIC FORCEPS

Arterienklippen
Pinces Hemostatiques

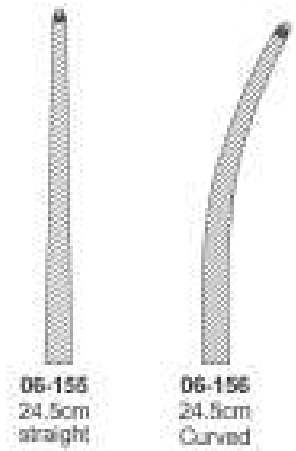
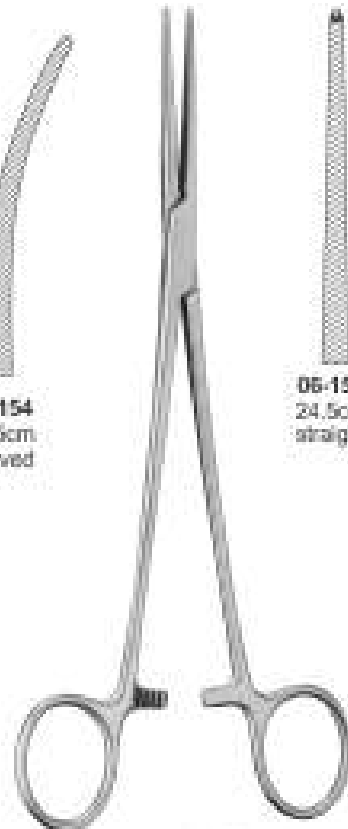
Pinzas Hemostaticas
Pinze Emostatiche



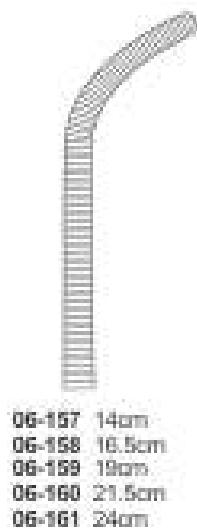
Haisted Haemostatic Forceps



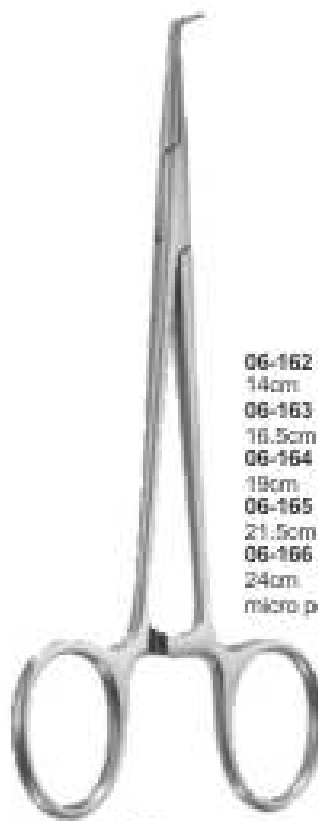
Bengolea Haemostatic Forceps



Bengolea Haemostatic Tissue Forceps
(rat tooth: 1x2 teeth)

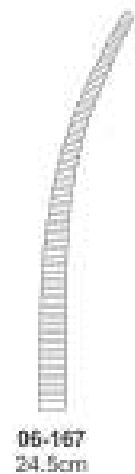
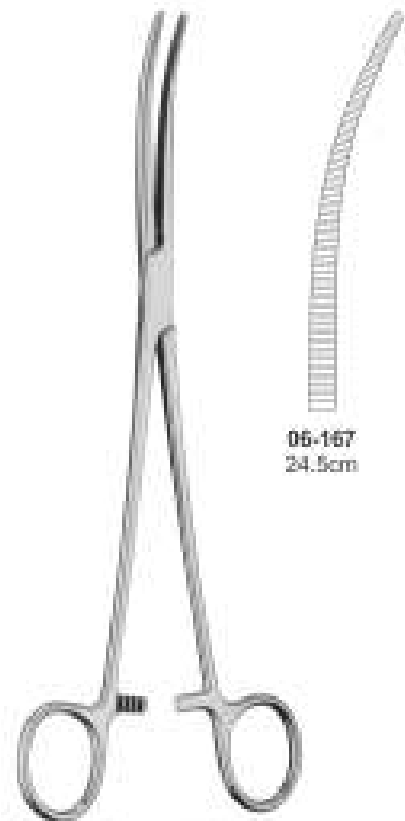


Mixer-O' Shaughnessy
Haemostatic Forceps



06-162
14cm
06-163
16.5cm
06-164
19cm
06-165
21.5cm
06-166
24cm
micro point

Mixer-O' Shaughnessy
Haemostatic Forceps



Crafoord Haemostatic Forceps

HAEMOSTATIC FORCEPS

Arterienklemmen

Pinças Hemostáticas

Pinces Hemostatiques

Pinze Emostatiche



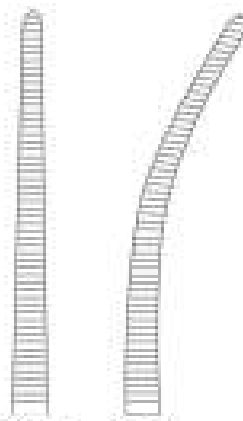
Herrick Haemostatic Forceps
06-168 23cm



Roberts Haemostatic Forceps

06-169
22cm
straight

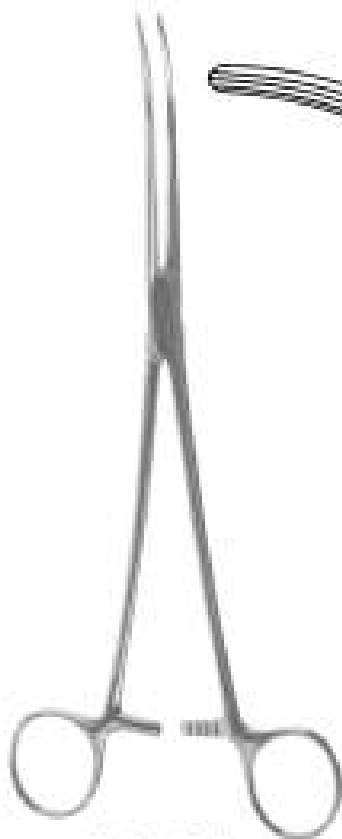
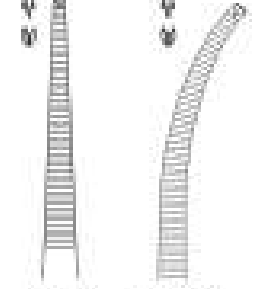
06-170
22cm
Curved



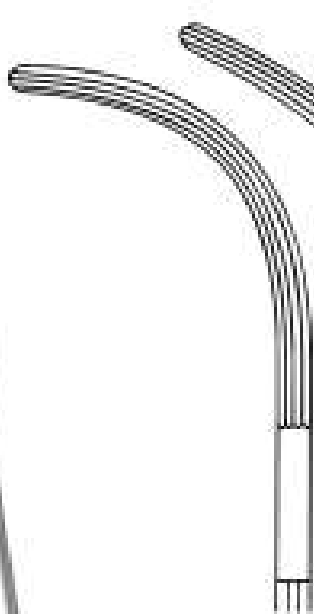
**Dixon-Lovelace
Haemostatic Tissue Forceps**

06-171
15.5cm
straight
(1x2teeth)

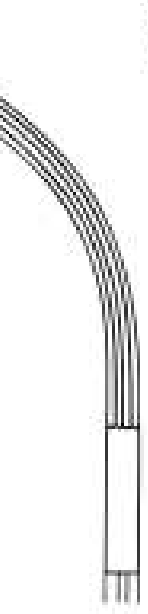
06-172
15.5cm
Curved
(1x2teeth)



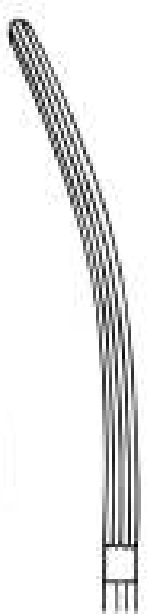
**Croftord-Sellers
Haemostatic Forceps**



06-173
22cm



06-174
23cm



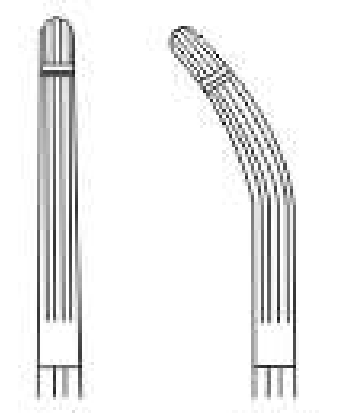
06-175
24cm



**Heaney / Ballantine
Haemostatic Forceps**

06-176
20cm
Straight,
Serrated

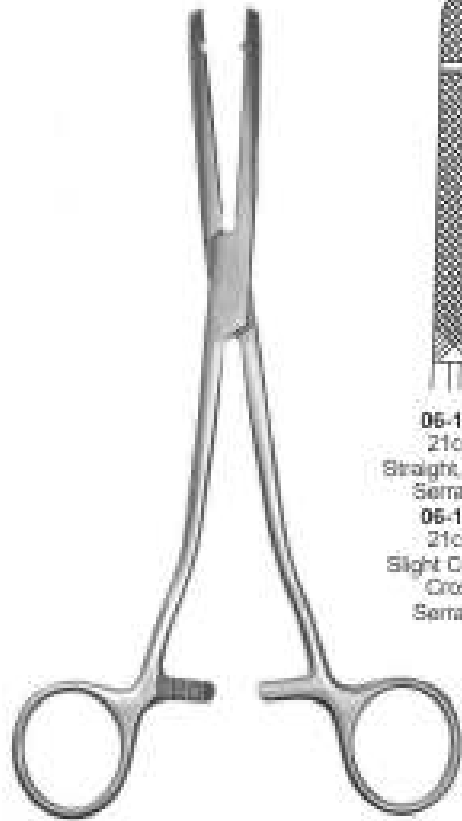
06-177
20cm
Slight Curve,
Serrated



HAEMOSTATIC FORCEPS

Arterienklemmen
Pinces Hemostatiques

Pinzas Hemostaticas
Pinze Emostatiche

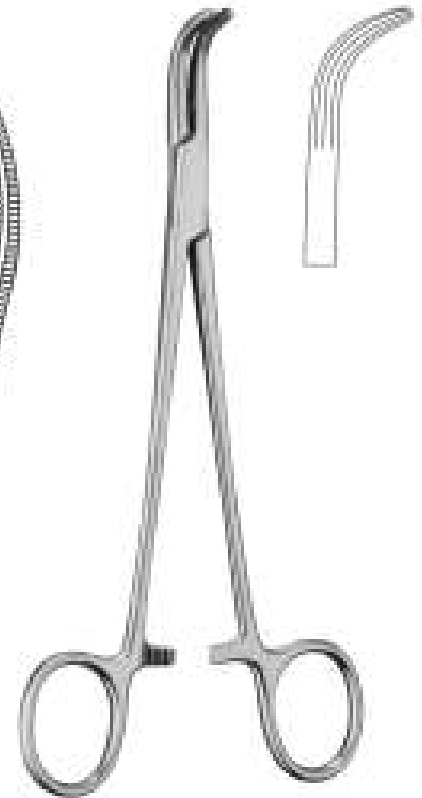


**Heaney / Rezak
Haemostatic Forceps**

06-178
21cm
Straight, Cross
Serrated
06-179
21cm
Slight Curved,
Cross
Serrated



Stille Haemostatic Forceps
06-180 23cm



Lower Haemostatic Forceps
06-181 18cm



**Lahey (Sweet)
Haemostatic Forceps**

06-182
19cm
06-183
22cm



**Desjardins Haemostatic
Forceps**
06-184 22cm



**Mixer Haemostatic
Gall Duct Forceps**

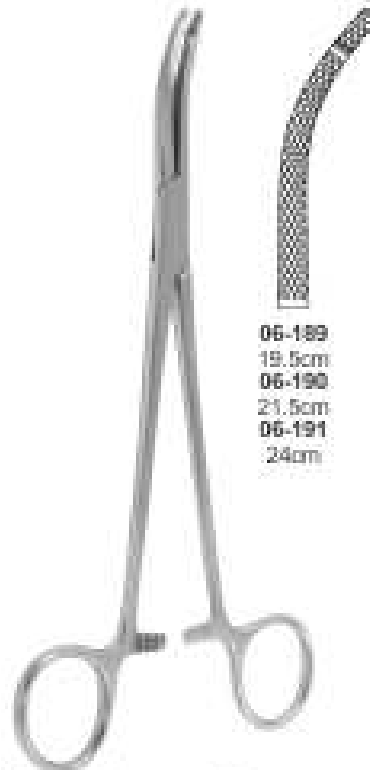
06-185
22cm

06-186
25cm



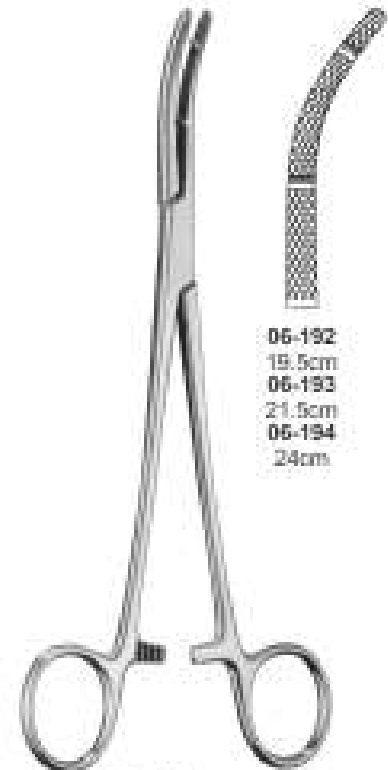
Mixer Forceps,
06-188 18.4cm
Fully curved,
original model

Mixer Forceps, Lee Modif
06-187 13.3cm
Curved jaws and angled
shanks, delicate



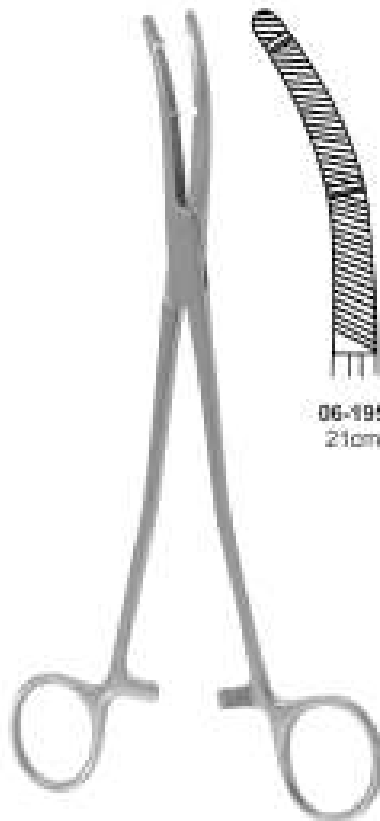
06-189
19.5cm
06-190
21.5cm
06-191
24cm

Heaney Haemostatic Forceps



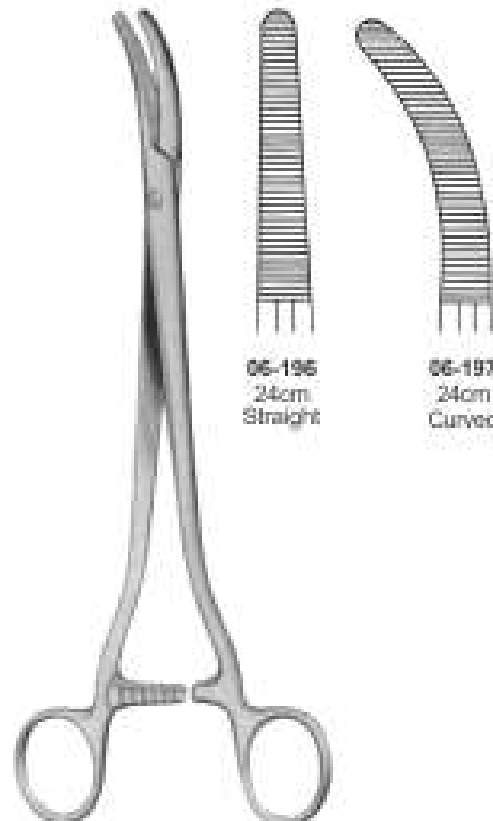
06-192
19.5cm
06-193
21.5cm
06-194
24cm

**Heaney Modif. Haemostatic
Forceps**



06-195
21cm

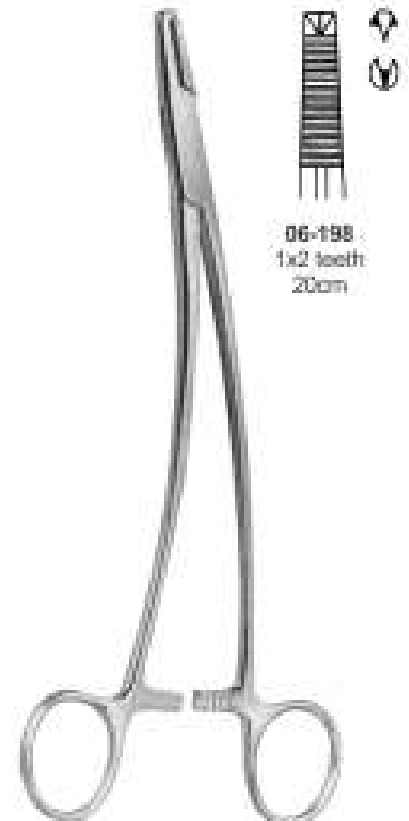
**Heaney-Kanter
Haemostatic Forceps**



06-196
24cm
Straight

06-197
24cm
Curved

**Segond-Landau
Haemostatic Forceps**



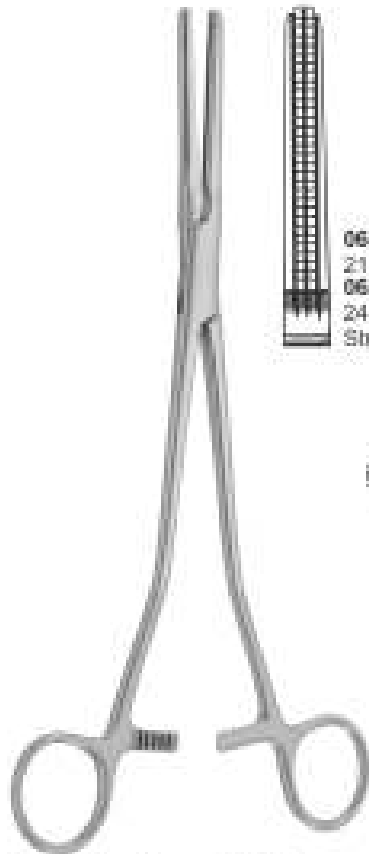
06-198
1x2 teeth
20cm

**Schindler Haemostatic Tissue
Forceps**

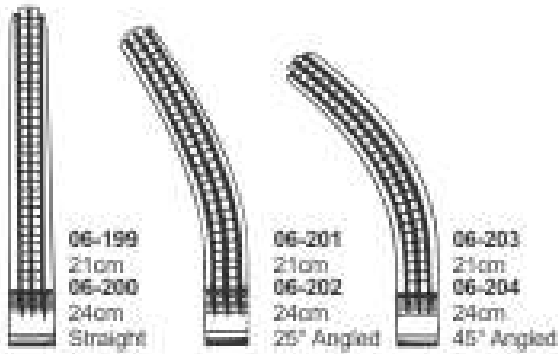
HAEMOSTATIC FORCEPS

Arterienklemmen
Pincas Hemostatiques

Pinzas Hemostaticas
Pinze Emostatiche

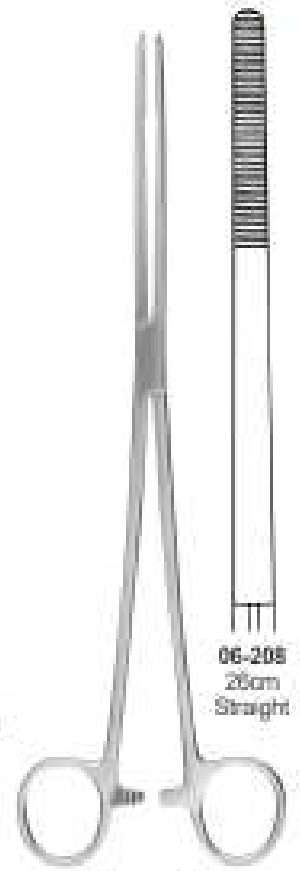


Parametrium Haemostatic Forceps



Bozemann Haemostatic Forceps

06-207
25cm
Curved
Serrated



Bozemann Haemostatic Forceps

06-208
26cm
Straight

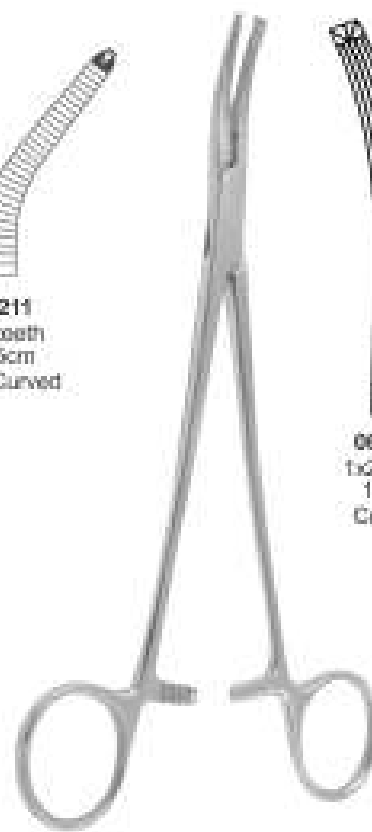
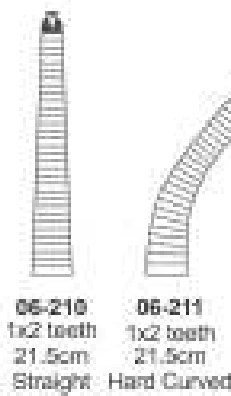


Westermark Haemostatic Forceps

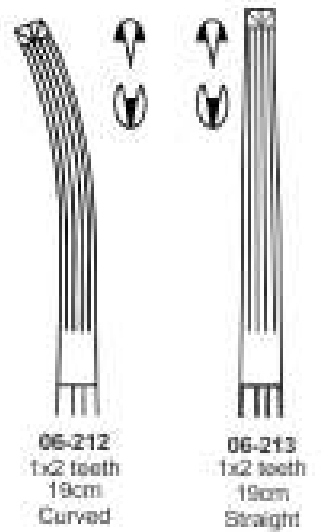
06-209
23cm
Straight

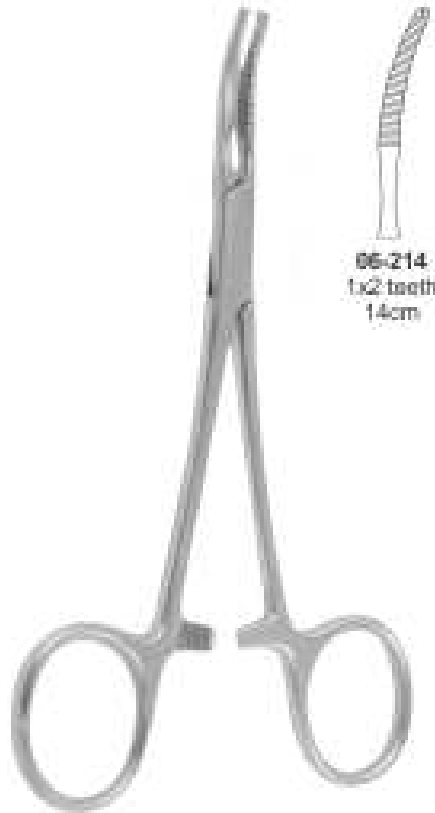


Phaneuf Haemostatic Tissue Forceps



Long Haemostatic Tissue Forceps





Baby-Mikulicz Haemostatic
Tissue Forceps



Mikulicz Haemostatic Tissue Forceps



Mikulicz Haemostatic Tissue Forceps



Mikulicz Haemostatic Tissue Forceps



Mikulicz Haemostatic Tissue Forceps



Faure Haemostatic Tissue Forceps

HAEMOSTATIC FORCEPS

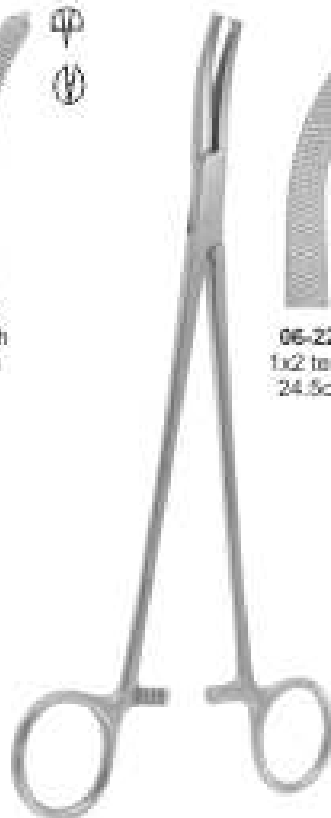
Arterienklemmen
Pincas Hemostatiquas

Pinças Hemostáticas
Pinze Emostatiche



06-220
1x2 teeth
23.5cm

Wertheim Haemostatic
Tissue Forceps



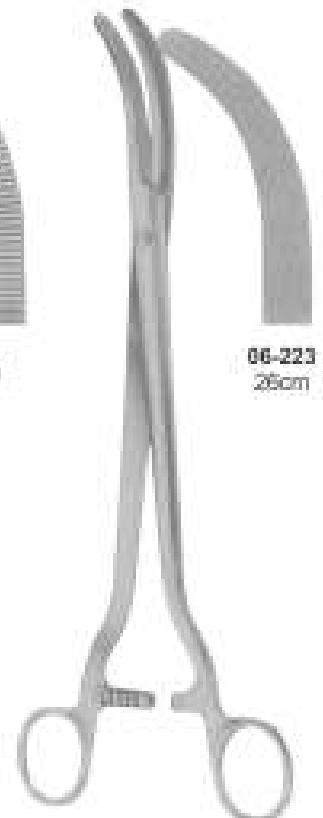
06-221
1x2 teeth
24.5cm

Wertheim Haemostatic
Tissue Forceps



06-222
25.5cm

Wertheim Hysterectomy
Forceps

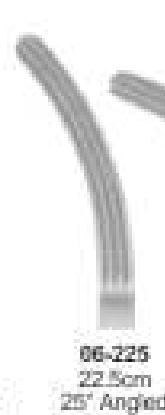
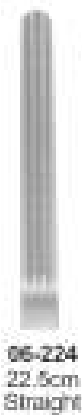


06-223
26cm

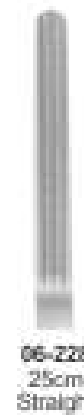
Wertheim Parametrium
Clamp



Heaney Atraumata
Hysterectomy Forceps



Wertheim Parametrium Clamps



HAEMOSTATIC FORCEPS

Arterienklemmen
Pinces Hemostatiques

Pinzas Hemostaticas
Pinze Emostatiche



Gemini Mixer Hemostatic Forceps
06-232 14cm
06-233 17.75cm
full curve, delicate



Dick Haemostatic Forceps



06-234 25.5cm
06-235 26.5cm
06-236 27.5cm



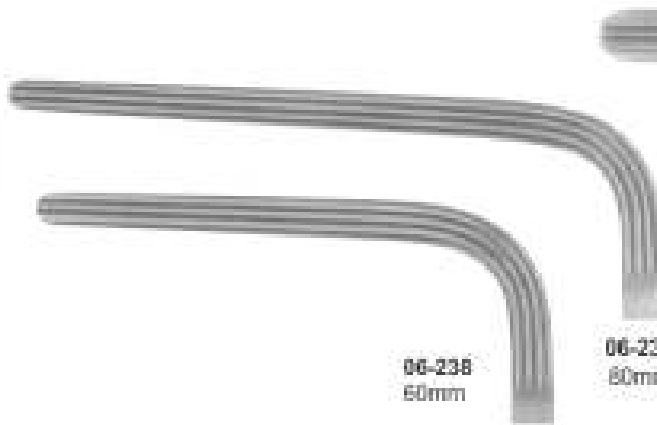
06-237
21.5cm



Wertheim-Cullen Haemostatic Forceps



Wertheim-Cullen Haemostatic Forceps
23cm



06-238
60mm

06-239
60mm



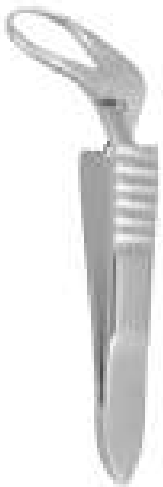
06-240
25cm



Wertheim Haemostatic Forceps

TOWEL FORCEPS

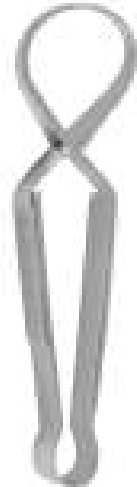
Tuchklemmen | Pinces à champs
Pinzas de campo | Pinze fissatele



Jones / Perforating Towel Forceps
06-241 9 cm
Slight Curve



Jones-Martin Towel Clamp sharp
06-242 8.5 cm



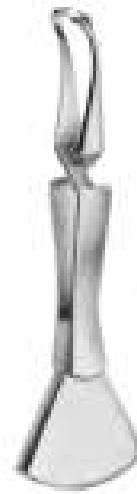
Engl. Modell Towel Forceps
06-243 9 cm



Schaedel Towel Forceps
06-244 9 cm



Thomson-Walker's Penile Clamps
06-245 9 cm
Cross-Action model.



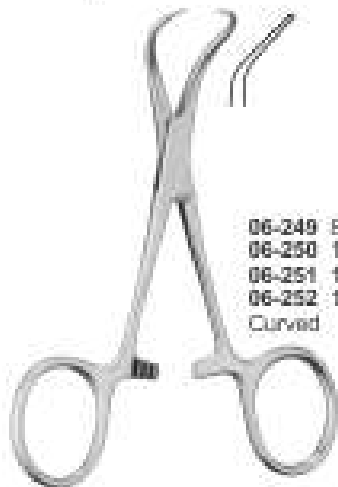
Doyen Towel Forceps
06-246 11cm



Doyen Towel Forceps
06-247 18 cm



Fricke Artery Forceps
06-248 13cm



Backhaus Towel Forceps

06-249 8cm
06-250 11cm
06-251 13cm
06-252 15cm
Curved



Backhaus Clip Towel Forceps
06-253 11cm
with clip for tubing or cable



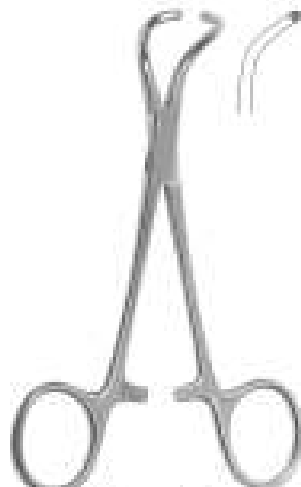
Roeder Towel Forceps
06-254 13cm
06-255 15cm
Curved, Serrated



Lorna Towel Forceps
06-256 9cm
06-257 11.4cm
06-258 13.5cm



Ball & Socket Towel Forceps
06-259 13cm
Non-perforating



Tohoku Towel Forceps
06-260 10cm
06-261 13cm
Non-Perforating



Non-Perforating Towel Forceps
06-262 11cm
06-263 13cm



Peers-Bertman Towel Forceps
06-264 14.5cm
Serrated

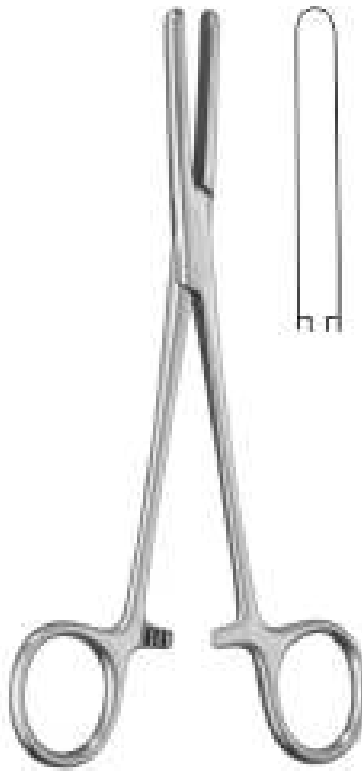
HAEMOSTATIC FORCEPS

Arterienklemmen
Pinces Hemostatiques

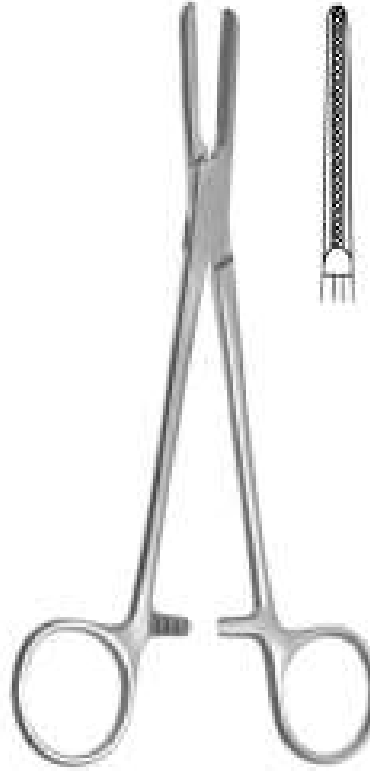
Pinzas Hemostaticas
Pinze Emostatiche



Bernhard Towel Forceps
06-265 16.5cm



Presbyterian Tubing Clamp
06-266 16.5cm
06-267 18cm
Straight, Smooth



Tubing Clamp
06-268 18cm
06-269 20cm
Cross Serrated

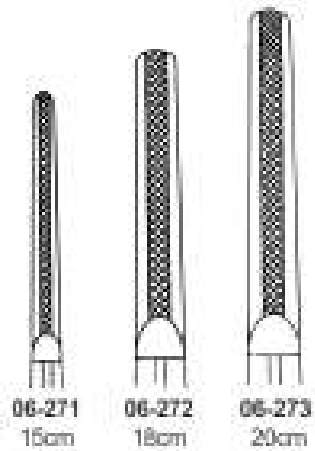


Klinikum Berlin Tubing Clamp

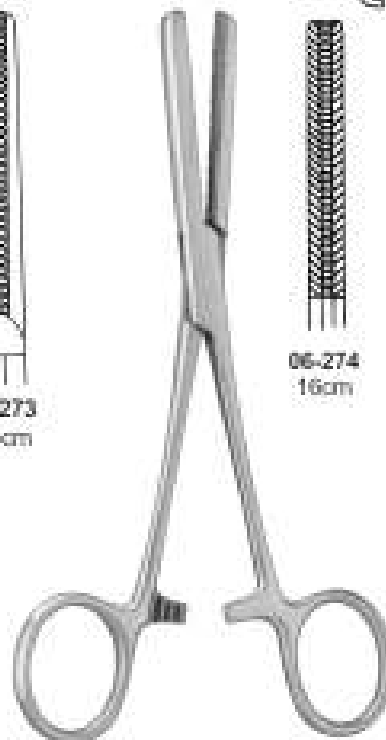
06-270
14.5cm
with long
ratchet



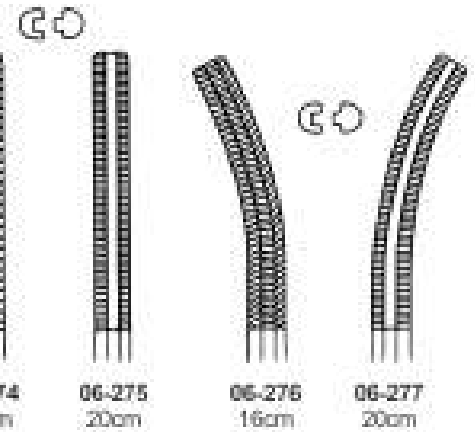
Tubing Clamp with Protector
Cross Serrated



06-271 15cm
06-272 18cm
06-273 20cm



Fergusson Tubing Clamp



06-274 16cm
06-275 20cm
06-276 16cm
06-277 20cm

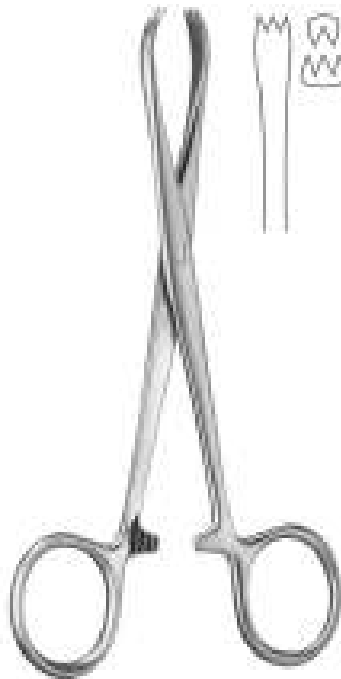
HAEMOSTATIC FORCEPS

Arterienklemmen
Pincas Hemostatiques

Pinças Hemostáticas
Pinze Emostatiche



Tuffier Haemostatic Forceps
06-278 13cm



Chaput Haemostatic Forceps
06-279 13cm



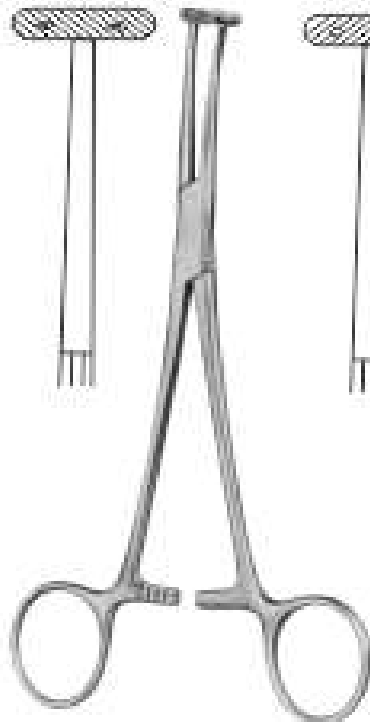
Pratt Haemostatic Forceps
06-280 15cm



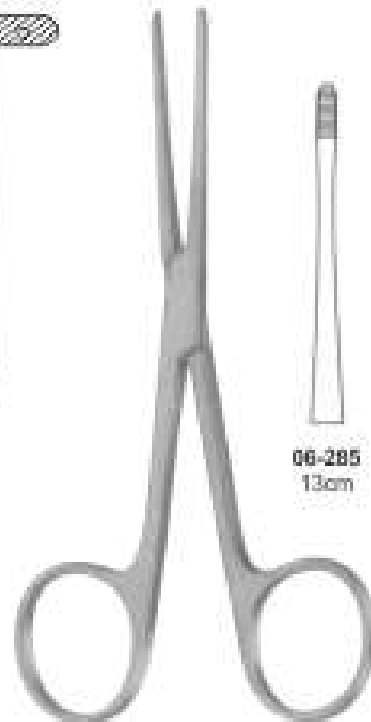
Pennington / Sizing Haemostatic Forceps
06-281 15.5cm
06-282 20cm
Straight



Martel Haemostatic Forceps
06-283 14cm



Willet-Martel Haemostatic Forceps
06-284 19cm



Lister Sinus Forceps



06-285
13cm

06-286
15.5cm

06-287
17.5cm

HAEMOSTATIC FORCEPS

Arterienklemmen
Pinces Hemostatiques

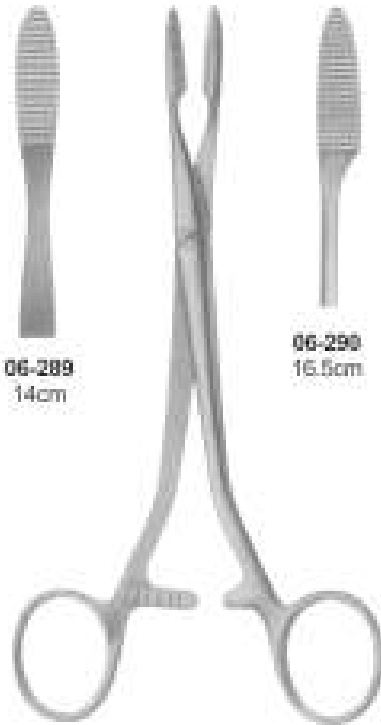
Pinzas Hemostaticas
Pinze Emostatiche



06-288
12.5cm



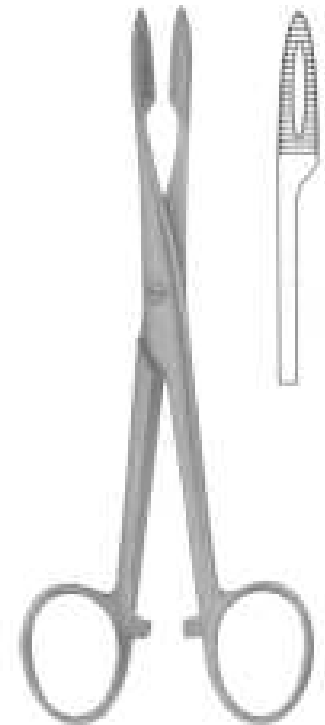
06-289
14cm



06-290
16.5cm



06-291
18.5cm

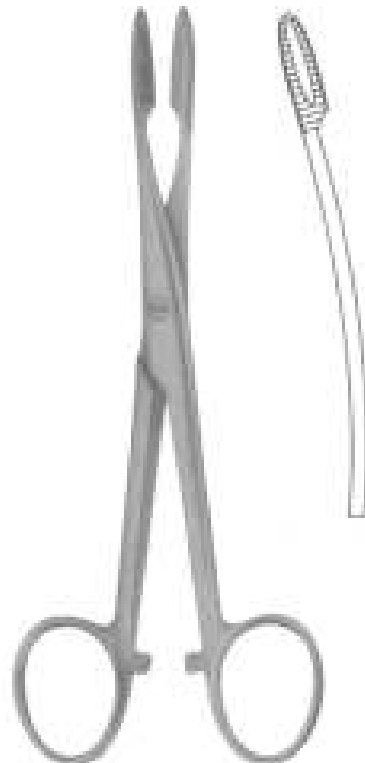


Collin Dressing
Haemostatic Forceps

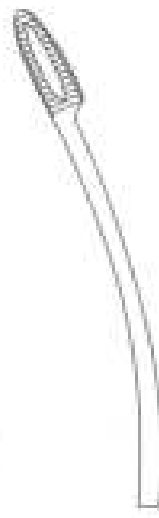
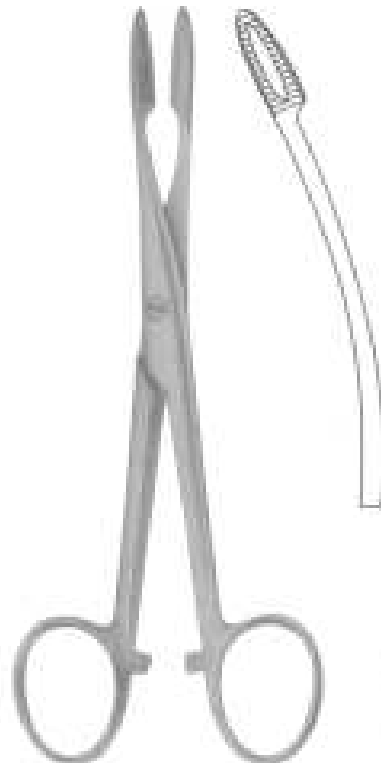
Colling Dressing
Haemostatic Forceps

Gross Maier Dressing Forceps
06-292 14.5cm straight
Without Ratchet

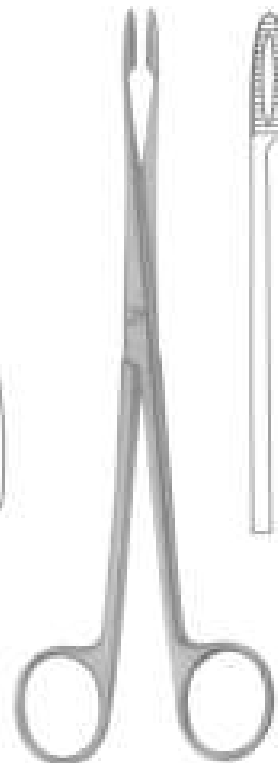
Gross Maier Dressing Forceps
06-293 14.5cm straight
With Ratchet



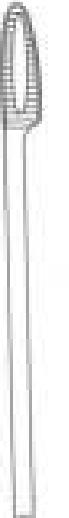
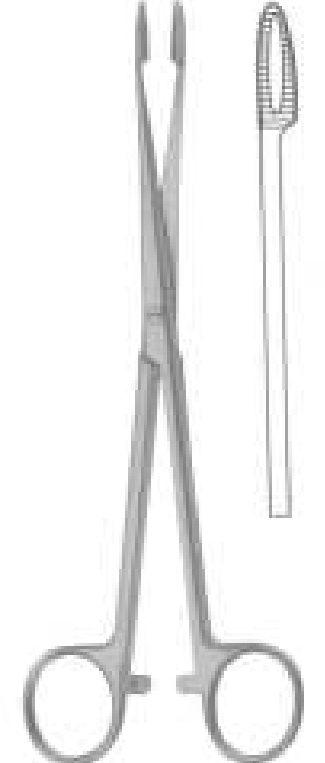
Gross Maier Dressing Forceps
06-294 14.5cm, curved
With Ratchet



Gross Maier Dressing Forceps
06-295 14.5cm, curved
With Ratchet



Gross Maier Dressing
Sponge & Dressing Forceps
06-296 20.5cm, straight
Without Ratchet

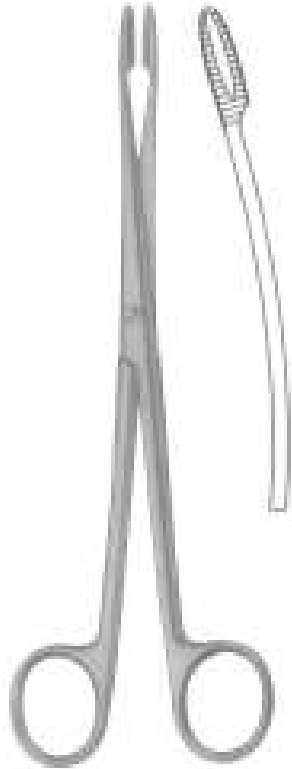


Gross Maier Dressing
Sponge & Dressing Forceps
06-297 17.8cm, straight
With Ratchet

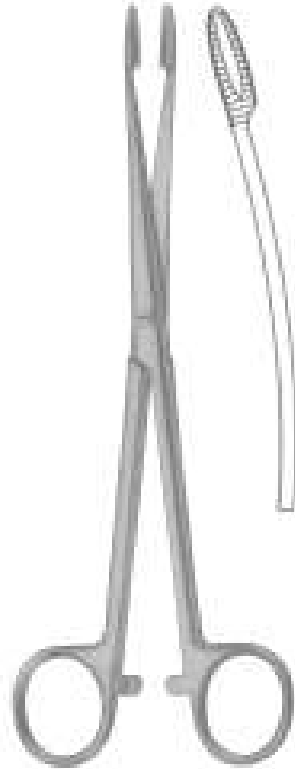
HAEMOSTATIC FORCEPS

Arterienklemmen
Pinces Hemostatiques

Pinzas Hemostaticas
Pinze Emostatiche



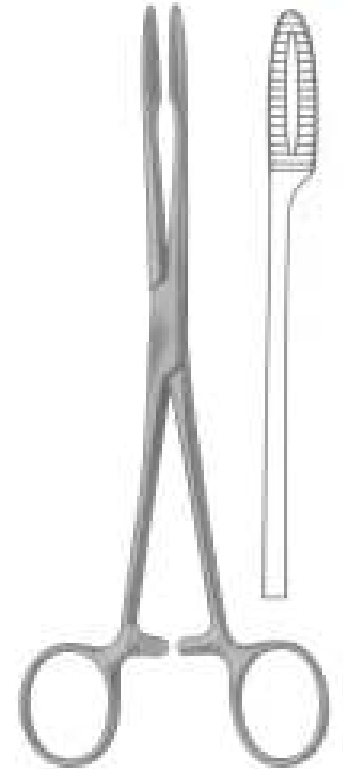
**Gross Maier Dressing
Sponge & Dressing Forceps**
06-298 20.5cm, curved
Without Ratchet
(bullet holding forceps)



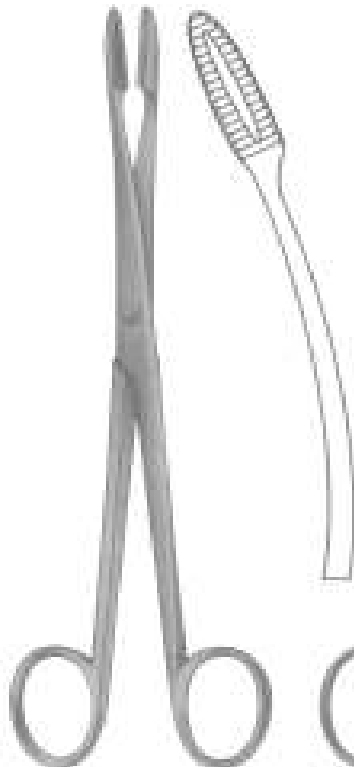
**Gross Maier Dressing
Sponge & Dressing Forceps**
06-299 17.8cm, curved
With Ratchet



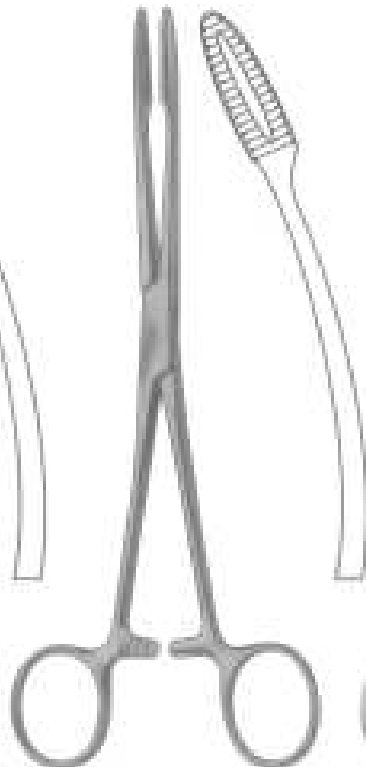
Gross Maier Dressing Forceps
06-300 26.5cm, straight
Without Ratchet
(bullet holding forceps)



Gross Maier Dressing Forceps
06-301 26.5cm, straight
With Ratchet
(bullet holding forceps)



Gross Maier Dressing Forceps
06-302 26.5cm, curved
Without Ratchet
(bullet holding forceps)

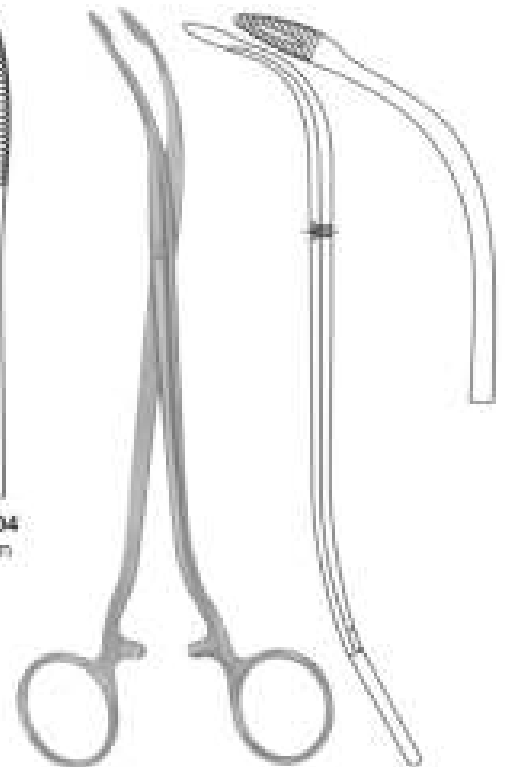


Gross Maier Dressing Forceps
06-303 26.5cm, curved
With Ratchet
(bullet holding forceps)

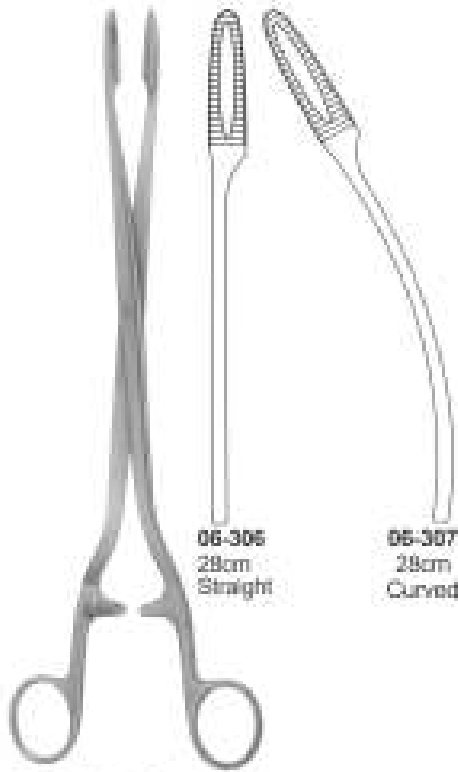


**Collin Sponge &
Dressing Forceps**

06-304
24cm



**Duplay Sponge &
Dressing Forceps**
06-305 15cm
Slight Curve



06-305
28cm
Straight

06-307
28cm
Curved

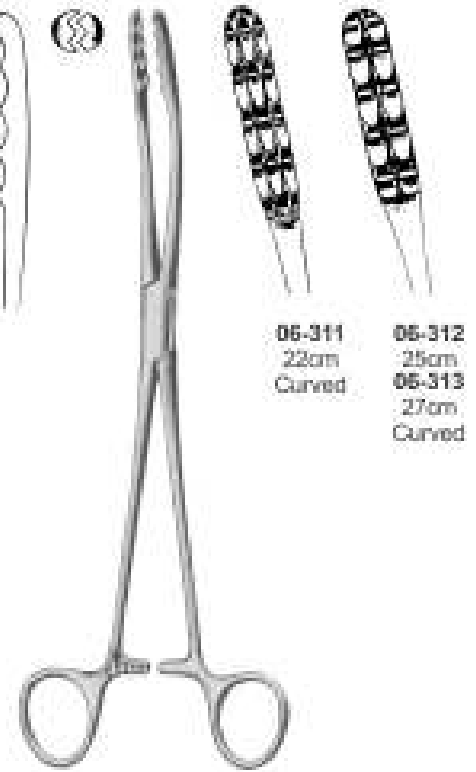
Sims-Maier Sponge & Dressing Forceps



06-308
22cm
Straight

06-309
25cm
06-310
17cm
Straight

Ulrich Sponge Forceps



06-311
22cm
Curved

06-312
25cm
06-313
27cm
Curved

Ulrich Sponge Forceps



06-314
22cm
Straight

06-315
22cm
Curved

Aesculap Sponge & Dressing Forceps



06-316
24cm
Straight

Fletcher Sponge Forceps



06-317
24cm
Slight
Curve

Fletcher Sponge Forceps



06-318
25cm
Straight

Pelkmann Sponge Forceps

HAEMOSTATIC FORCEPS

Arterienklemmen

Pinças Hemostáticas

Pinces Hemostatiques

Pinze Emostatiche



06-319
25cm
Curved

Peikmann Sponge
Forceps



06-320
24cm

Cheron Forceps
Handles Laterally
Angled



06-321
20.5cm
Straight

Duplay Sponge Forceps



06-322
20.5cm
Curved

Duplay Sponge Forceps

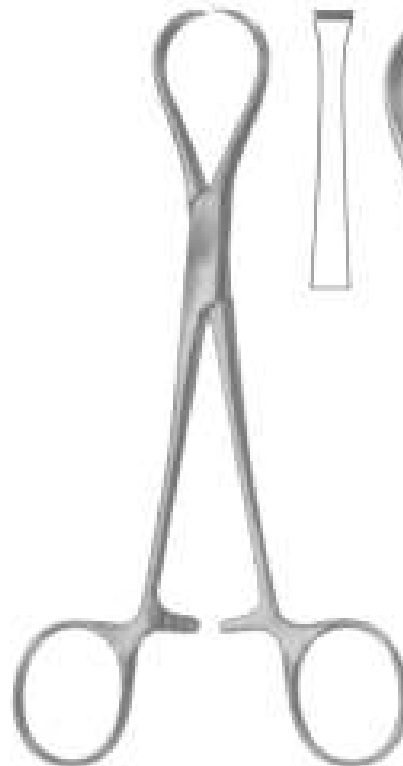


Haywood Smith
Sponge Forceps
06-323 25cm



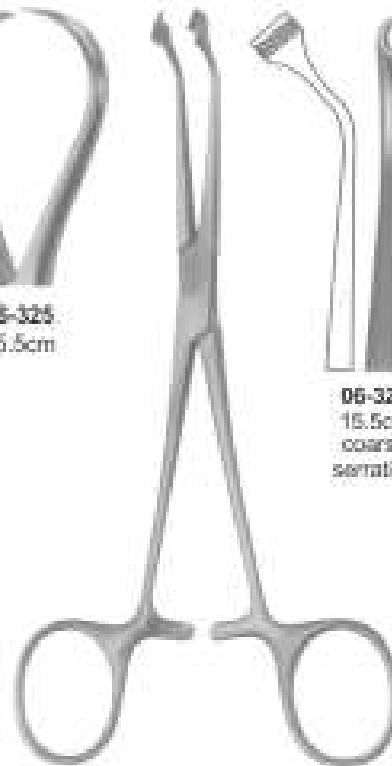
06-324
21cm

Emmet Sponge &
Dressing Forceps



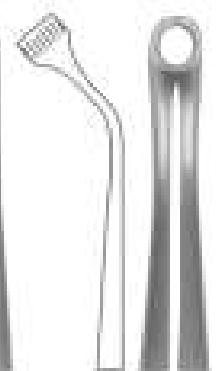
06-325
15.5cm

Tendon Seizing Forceps



06-326
15.5cm
coarse
serration

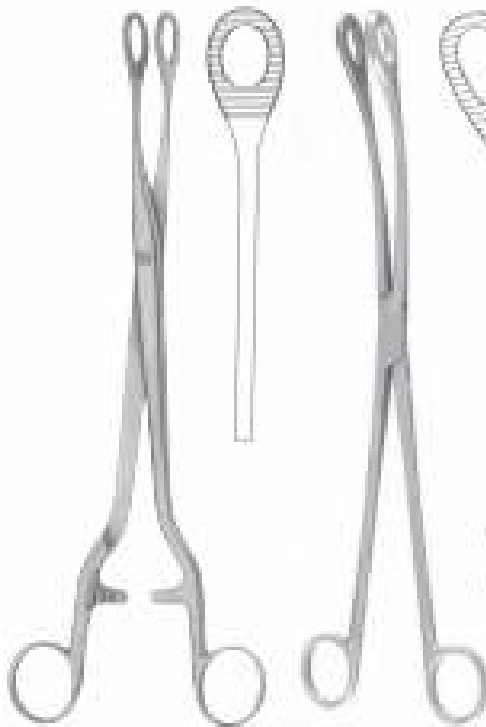
Herz Tendon Seizing Forceps



06-327
15.5cm
fine
serrations

Arterienklemmen
Pinces Hemostatiques

Pinzas Hemostaticas
Pinze Emostatiche



Noto Sponge & Dressing Forceps
06-328 28cm

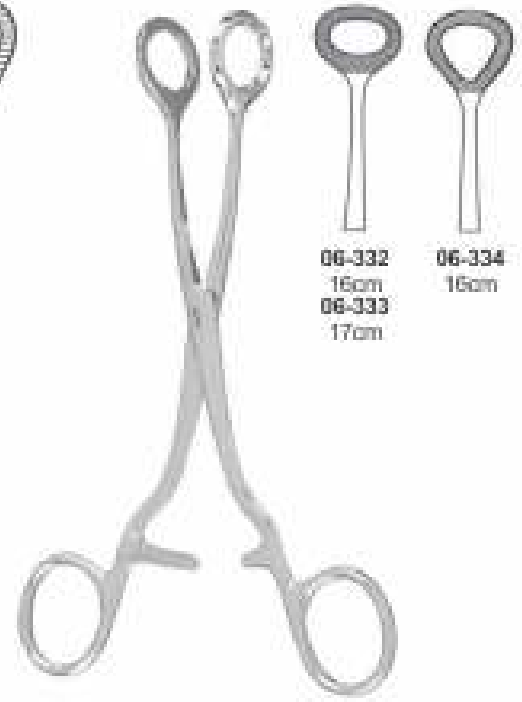
Kelly Sponge & Dressing Forceps

06-329
32cm
Curved



Heywood-Smith Sponge & Dressing Forceps
06-331 20cm

06-330
32cm
Straight



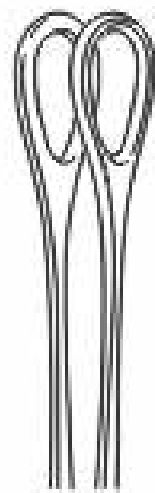
Collin Sponge & Dressing Forceps

06-332
16cm
06-333
17cm

06-334
16cm



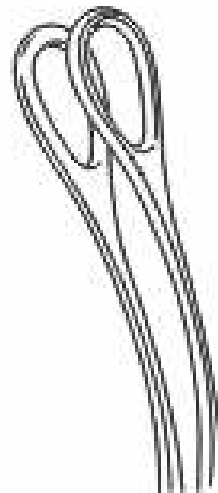
Foerster-Ballenger Sponge Forceps & (bullet holding forceps)



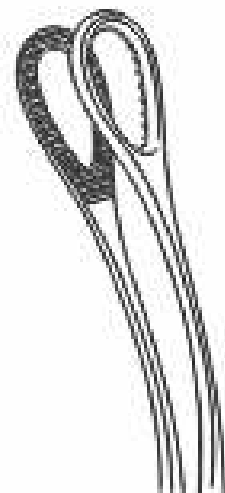
06-335 18cm
06-336 20cm
06-337 24cm
Straight Smooth



06-338 18cm
06-339 20cm
06-340 24cm
Straight Serrated



06-341 18cm
06-342 20cm
06-343 24cm
Curved Smooth

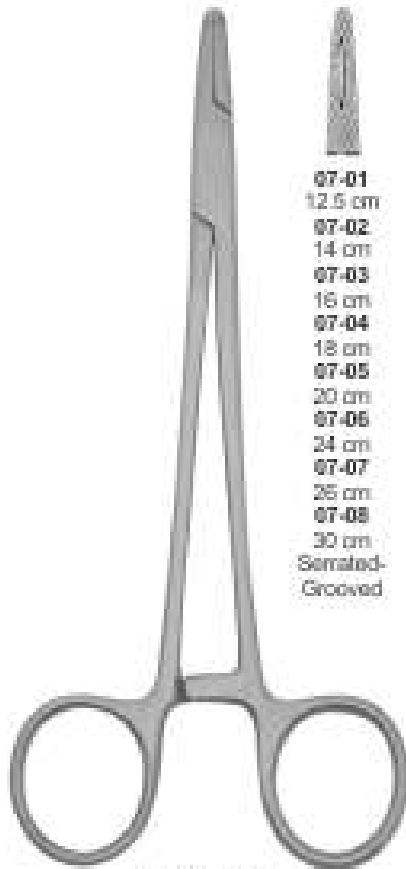


06-344 18cm
06-345 20cm
06-346 24cm
Curved Serrated

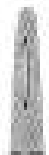
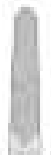
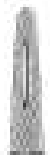


NEEDLE HOLDERS

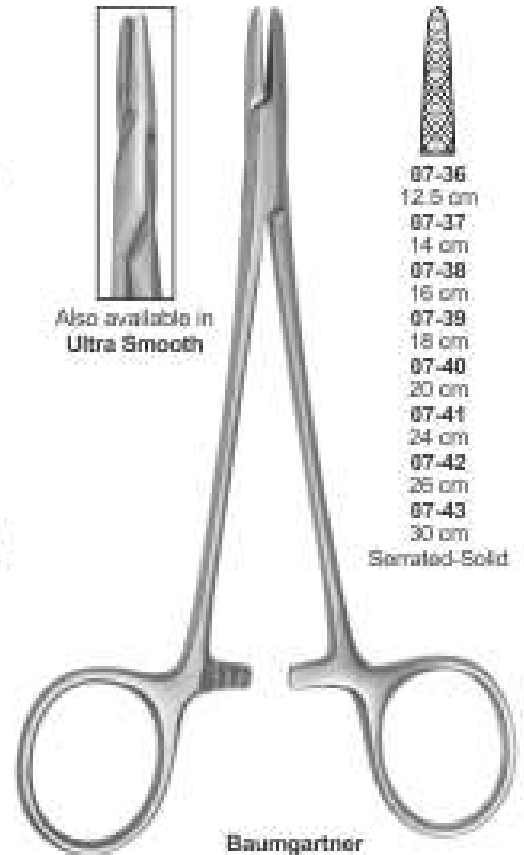
Nadelhalter
Prote-aguillas

Porta-agujas
Porta aghi




**Mayo-Hegar
Needle Holders**

				
07-01 12.5 cm	07-09 12.5 cm	07-17 16 cm	07-20 12.5 cm	07-28 12.5 cm
07-02 14 cm	07-10 14 cm	07-18 18 cm	07-21 14 cm	07-29 14 cm
07-03 16 cm	07-11 16 cm	07-19 20 cm	07-22 16 cm	07-30 16 cm
07-04 18 cm	07-12 18 cm	Serrated- Grooved left handed	07-23 18 cm	07-31 18 cm
07-05 20 cm	07-13 20 cm		07-24 20 cm	07-32 20 cm
07-06 24 cm	07-14 24 cm		07-25 24 cm	07-33 24 cm
07-07 26 cm	07-15 26 cm		07-26 26 cm	07-34 26 cm
07-08 30 cm	07-16 30 cm		07-27 30 cm	07-35 30 cm
Serrated- Grooved	Serrated		Serrated- Grooved Curved	Serrated Curved



**Baumgartner
Needle Holder**

Also available in
Ultra Smooth

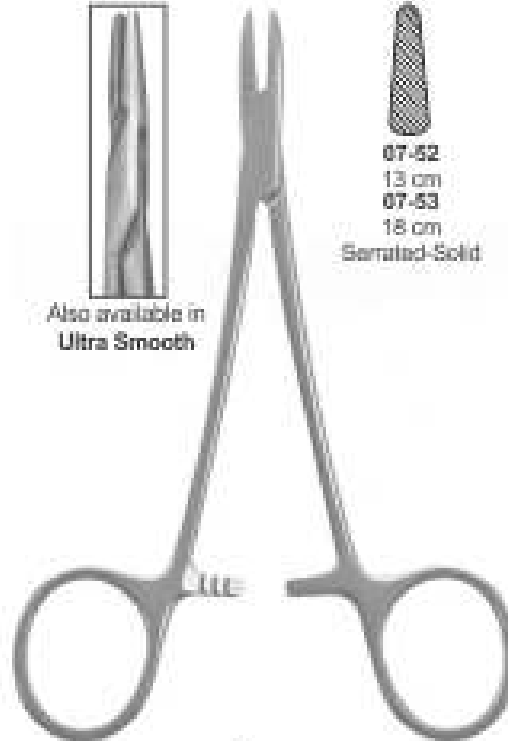

07-36 12.5 cm
07-37 14 cm
07-38 16 cm
07-39 18 cm
07-40 20 cm
07-41 24 cm
07-42 26 cm
07-43 30 cm
Serrated-Solid



**Webster
Needle Holder**

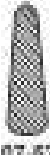
Also available in
Ultra Smooth

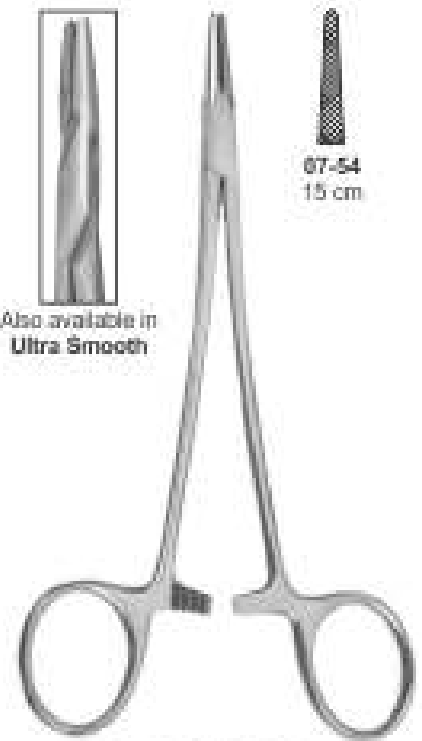

07-44 11.5 cm
07-45 12 cm
07-46 12.5 cm
07-47 13 cm
07-48 14 cm
07-49 15 cm
07-50 18 cm
07-51 20 cm
Smooth



**Brown
Needle Holder**

Also available in
Ultra Smooth


07-52 13 cm
07-53 18 cm
Serrated-Solid



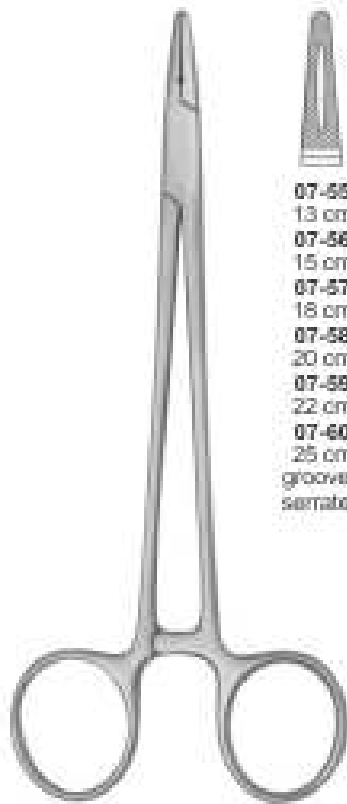
**Baby Crile-Wood
Needle Holder**

Also available in
Ultra Smooth


07-54 15 cm

NEEDLE HOLDERS

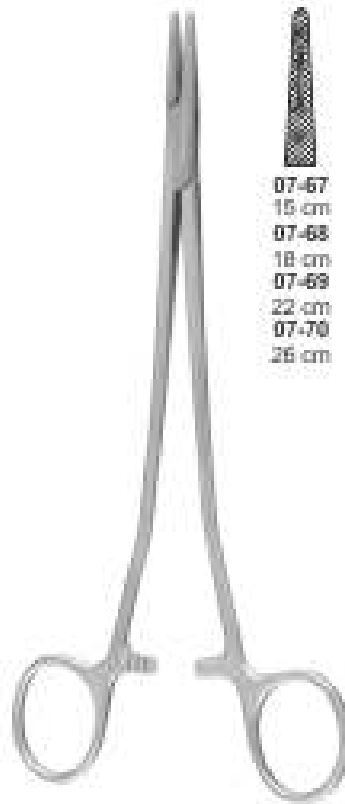
Needleholder | Porta-agujas
 Porte-aiguilles | Porta aghi



**Crisle-Wood
 Needle Holder**

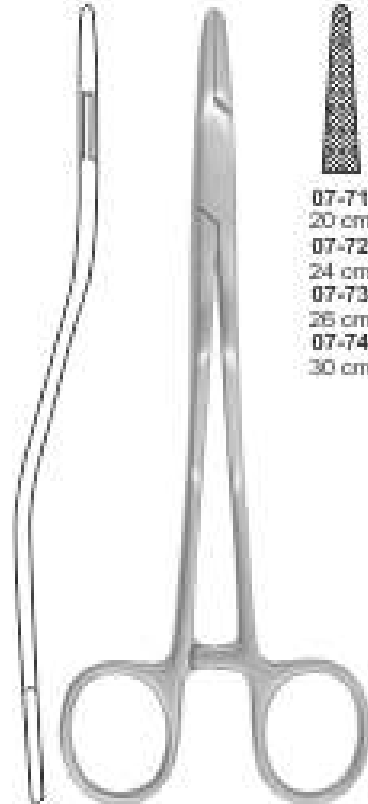
- 07-55 13 cm
- 07-56 15 cm
- 07-57 18 cm
- 07-58 20 cm
- 07-59 22 cm
- 07-60 25 cm
- grooved
- serrated

- 07-61 13 cm
- 07-62 15 cm
- 07-63 18 cm
- 07-64 20 cm
- 07-65 22 cm
- 07-66 25 cm
- solid
- serrated



Sargol Needle Holders

- 07-67 15 cm
- 07-68 18 cm
- 07-69 22 cm
- 07-70 26 cm



Bozemann Needle Holders

- 07-71 20 cm
- 07-72 24 cm
- 07-73 26 cm
- 07-74 30 cm



Jameson Needle Holders

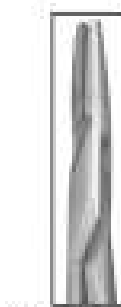
- 07-75 23 cm

Also available in
 Ultra Smooth

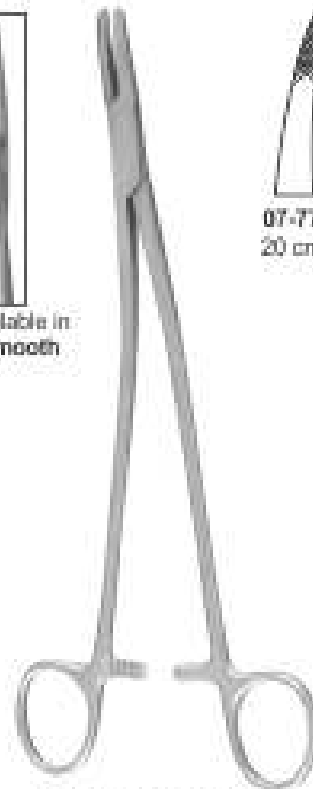


Finocchio Needle Holders

- 07-76 27 cm



Also available in
 Ultra Smooth



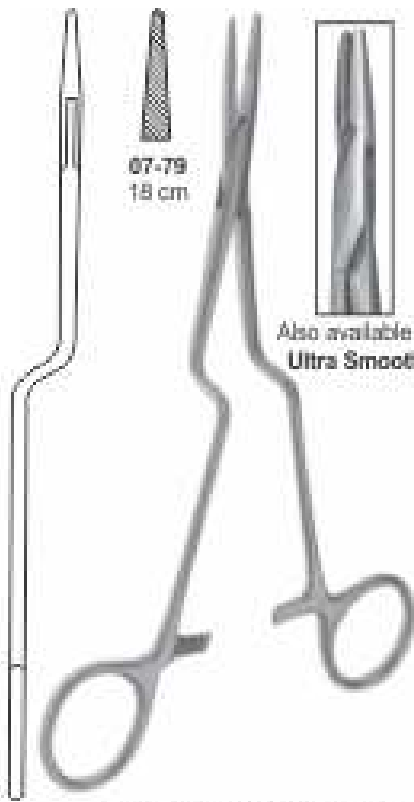
Stratte Needle Holders

- 07-77 20 cm

- 07-78 23 cm

NEEDLE HOLDERS

Nadelhalter	Porta-agujas
Prote-agulhas	Porta aghi



07-79
18 cm

Also available in
Ultra Smooth

Jacobson Needle Holders



07-80
20 cm
Box Joint

Also available in
Ultra Smooth

Thomson Walker
Needle Holders



07-81 18 cm
07-82 25 cm
Pound Action Joint

Naunton Morgan Needle Holders



07-83
17 cm

Mass. General Hospital
Needle Holders



07-84
18 cm

Adson Needle Holders



07-85
18 cm

New Orleans Needle Holders

NEEDLE HOLDERS

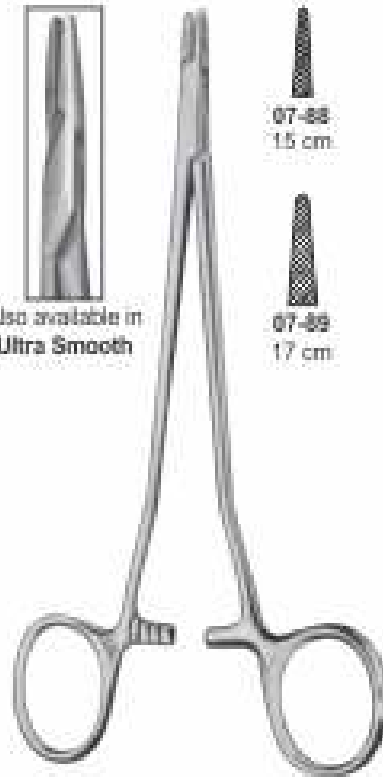
Nadelhalter | Porta-agujas
 Prote-agulhas | Porta aghi



07-86
20 cm
Cvd.

07-87
27 cm
Cvd.

Heaney Needle Holders

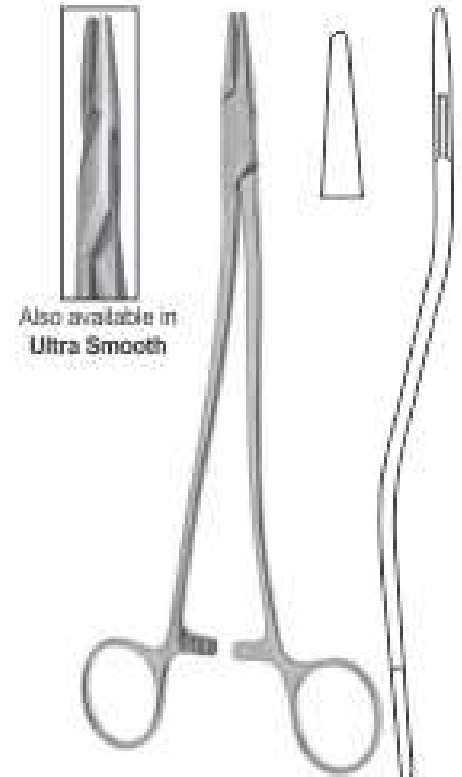


07-88
15 cm

07-89
17 cm

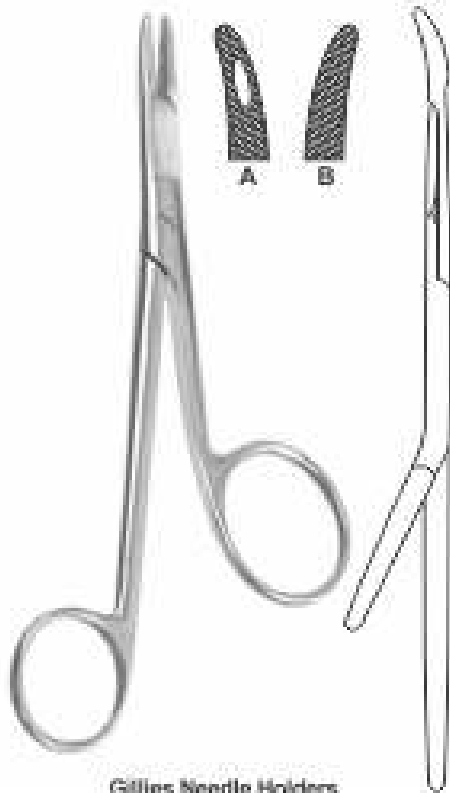
Also available in
Ultra Smooth

Senning Needle Holders
(Schwed. Model)



Also available in
Ultra Smooth

Werheim Needle Holders
07-90 20 cm
07-91 24 cm



A

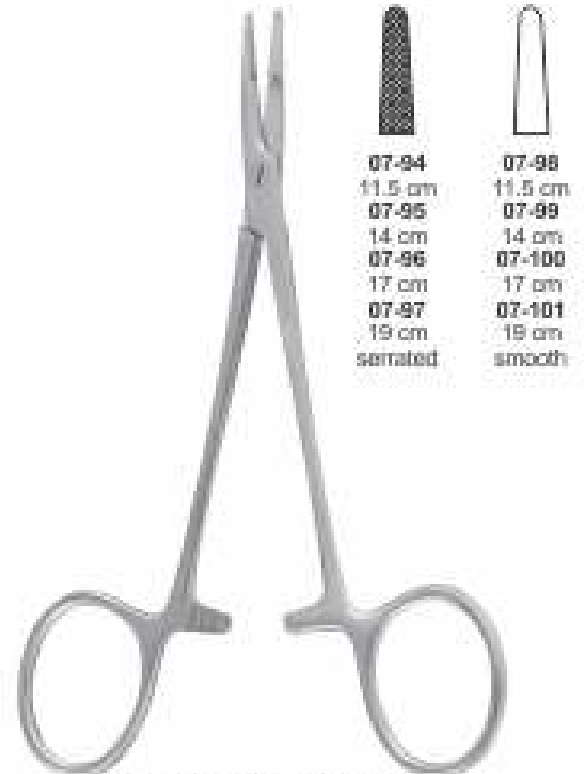
B

Gillies Needle Holders
07-92 16 cm



07-93
27 cm
Serrated

Masson-Luethy
Needle Holders



07-94
11.5 cm
07-95
14 cm
07-96
17 cm
07-97
19 cm
serrated

07-98
11.5 cm
07-99
14 cm
07-100
17 cm
07-101
19 cm
smooth

Olsen-Hegar Needle Holders

NEEDLE HOLDERS

Nadelhalter	Porta-agujas
Prote-agulhas	Porta aghi



07-102
13 cm
serrated

07-103
13 cm
smooth

Halsey Needle Holders

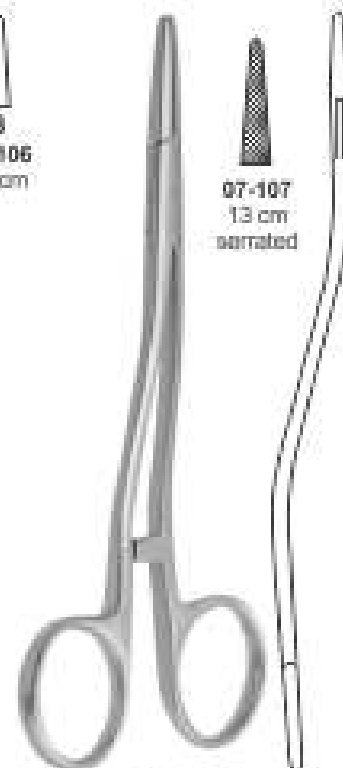


A
07-104
12 cm

B
07-105
12 cm

B
07-106
12 cm

Derf Needle Holders



07-107
13 cm
serrated

Kilner Needle Holders



07-108
13 cm

Neivert Needle Holders



07-109
12.5 cm

Collier Needle Holders



07-110
12.5 cm

Doyen Needle Holders

NEEDLE HOLDERS

Needleholder | Porta-agujas
 Prote-agulhas | Porta aghi



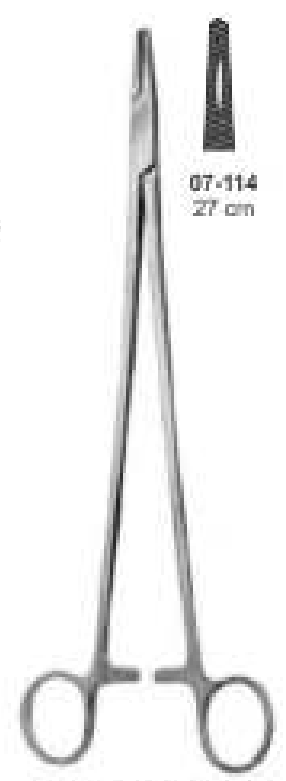
**Crite-Murray
Needle Holders**



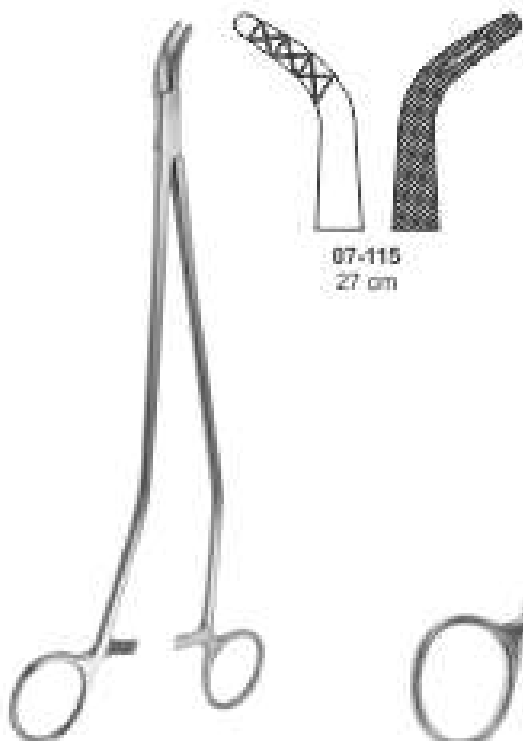
**Metzenbaum
Needle Holders**



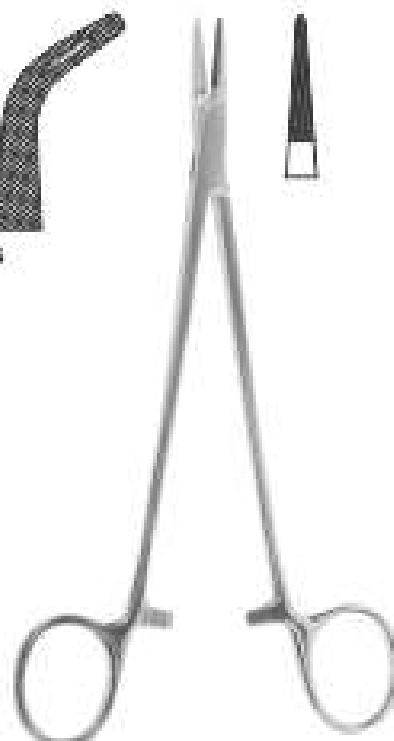
**Wangensteen
Needle Holders**



Masson Needle Holder



Johnson Needle Holders



De Bakay Needle Holders

07-116 18 cm
 07-117 20 cm
 07-118 22 cm
 07-119 25 cm



Intracardiac Needle Holders

07-120 18 cm
 07-121 20 cm
 07-122 22 cm
 07-123 25 cm

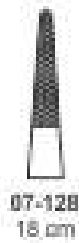
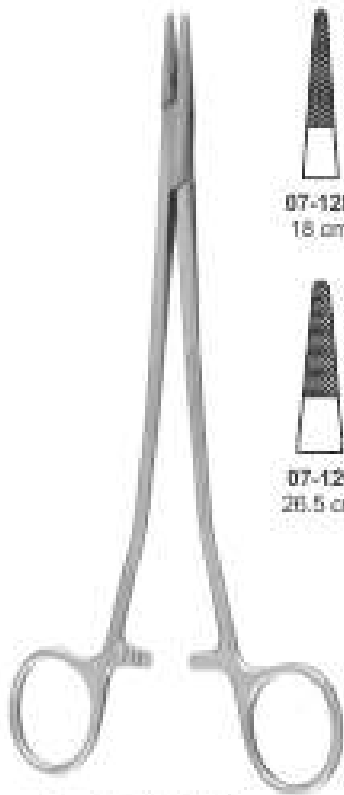


Microvascular Needle Holders

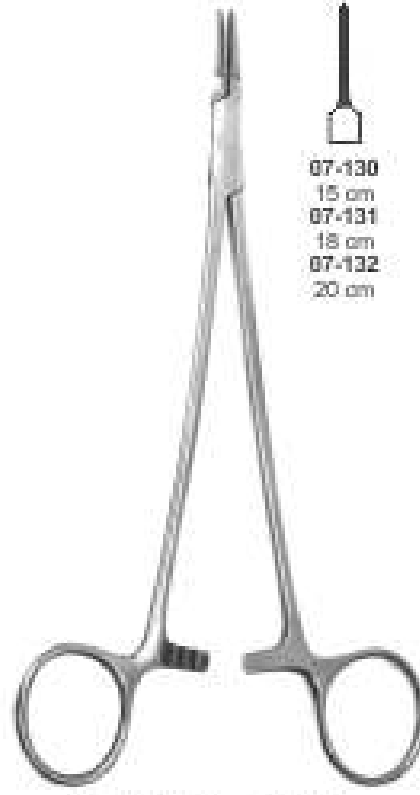
07-124 18 cm
 07-125 20 cm
 07-126 22 cm
 07-127 25 cm

NEEDLE HOLDERS

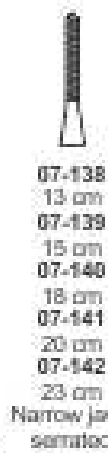
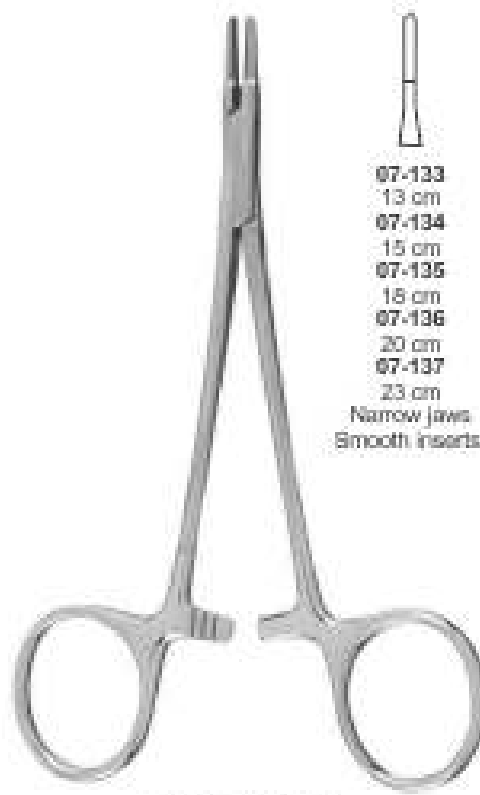
Nadelhalter | *Porta-agujas*
Prote-agulhas | *Porta aghi*



Sarot Needle Holders



Micro Ryder Needle Holders



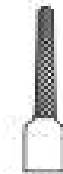
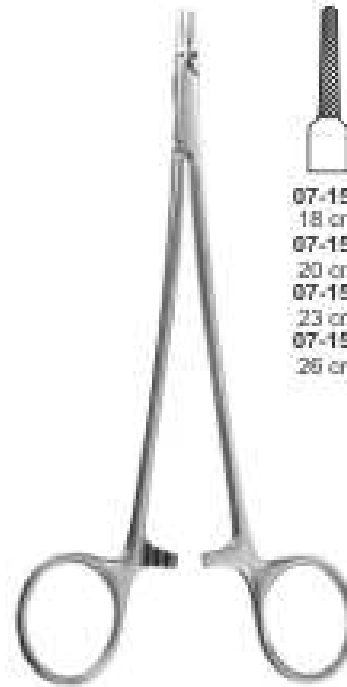
Ryder Needle Holders
Narrow jaws.



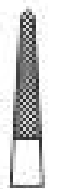
French-Eye Needle Holder
07-143 16 cm
07-144 18 cm
07-145 20 cm
07-146 22 cm
07-147 25 cm
Narrow Tip



French-Eye Needle Holder
07-148 16 cm
07-149 18 cm
07-150 20 cm
07-151 22 cm



**Cooly Intracardiac
Needle Holders**
Straight, narrow jaw.



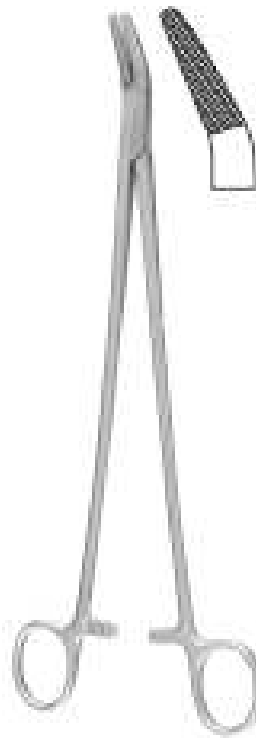
**Debakey Cardiovascular
Needle Holders**
Delicate patterns.
Straight jaw, serrated.

NEEDLE HOLDERS

Nadelhalter | Porta-agujas
 Prote-ajullies | Porta aghi



Finochietto Needle Holders
 07-160 13 cm
 07-161 16 cm
 07-162 19 cm
 07-163 21 cm



Finochietto Needle Holders
 07-164 13 cm Angled
 07-165 16 cm Angled
 07-166 19 cm Angled



07-167
 20 cm
 Curved

Finochietto Needle Holders



07-168
 14 cm
 07-169
 17 cm
 07-170
 20 cm

Mathieu Needle Holders



07-171
 14 cm
 07-172
 16.5 cm
 07-173
 20 cm
 Narrow Jaws

Mathieu Needle Holders



07-174
 18 cm
 07-175
 23 cm

**Mayo Rochester
 Needle Holders**
 button release, screw joint.



07-176
 15 cm
 07-177
 18 cm
 07-178
 20 cm
 lined with
 copper.

Macphail Needle Holders



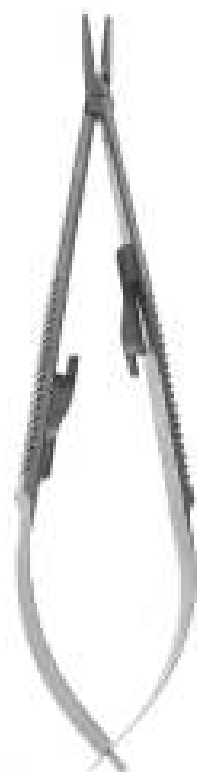
07-179
 15 cm

Crile Needle Holders

Nadelhalter | Porta-agujas
 Prote-agulillas | Porta aghi



07-180
13.5 cm

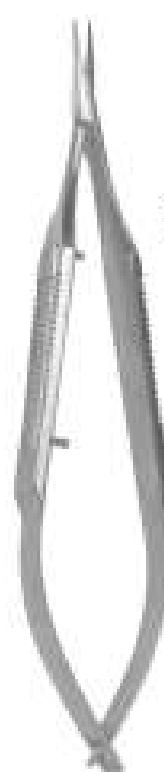


07-181
13 cm
with lock
straight

07-182
13 cm
with lock
curved

07-183
13 cm
without lock
straight

07-184
13 cm
without lock
curved



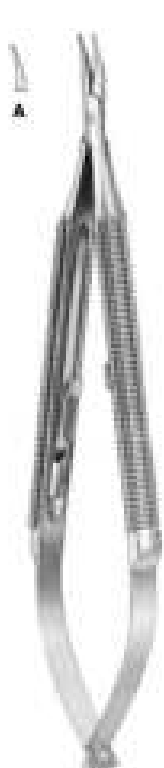
07-185
10 cm
07-186
14 cm
Straight, Smooth
with lock Straight

07-187
10 cm
07-188
14 cm
Curved, Smooth
with lock curved

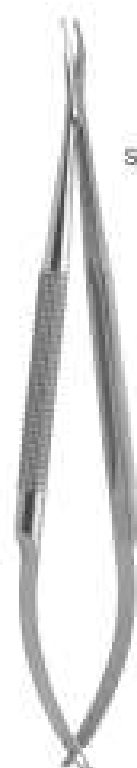
Toennis Needle Holders

Castroviejo Needle Holders

Troutman Needle Holders



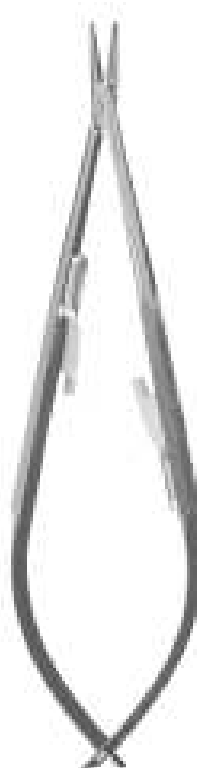
Barraquer Micro Needle Holders
07-189 11cm
07-190 12cm



Barraquer Needle Holders

07-191
13 cm
Straight, Smooth
without lock
Straight

07-192
13 cm
Curved, Smooth
without lock
curved



Castroviejo Needle Holders

07-193
14 cm
Straight
Smooth
with lock

07-194
14 cm
Straight
Smooth
without lock

07-195
14 cm
Curved
Smooth
with lock

07-196
14 cm
Curved
Smooth
without lock

07-197
18 cm
Straight
Smooth
with lock

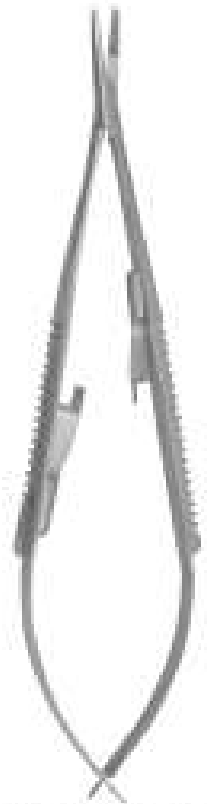
07-198
18 cm
Straight
Smooth
without lock

07-199
18 cm
Curved
Smooth
with lock

07-200
18 cm
Curved
Smooth
without lock

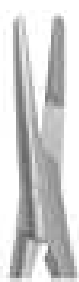
NEEDLE HOLDERS

Nadelhalter | Porta-agujas
 Prote-agulles | Porta aghi



07-201
 13 cm
 07-202
 15 cm

Gastroviejo Olsen Hegar /
 Needle Holders / Scissors



07-203
 12 cm

Boynton Needle Holders



07-204
 15 cm
 Str.

Arruga Needle Holders



07-205
 16 cm
 Cvd.

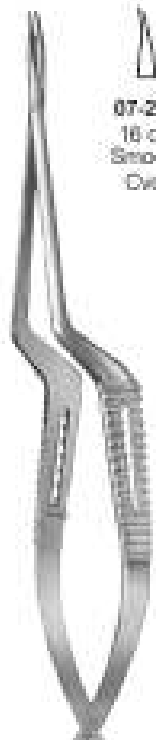


07-206
 19 cm
 07-207
 23 cm
 Smooth
 Str.

Micro Needle Holders

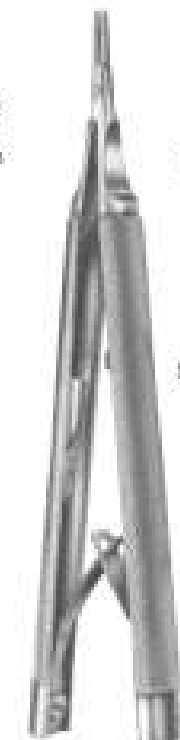


07-208
 19 cm
 07-209
 23 cm
 Smooth
 Cvd.



07-210
 18 cm
 Smooth
 Cvd.

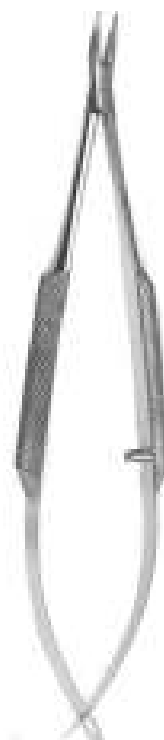
Micro Needle
 Holders



Gastroviejo Needle
 Holders

07-211
 12 cm
 Smooth Str
 with lock

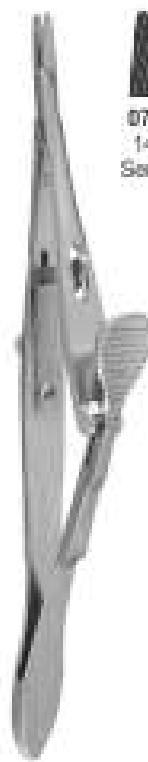
07-212
 12 cm
 Smooth Cvd
 with lock



Barraquer-Trounman
 Needle Holders

07-213
 10 cm
 07-214
 11.5 cm
 Smooth
 Str.

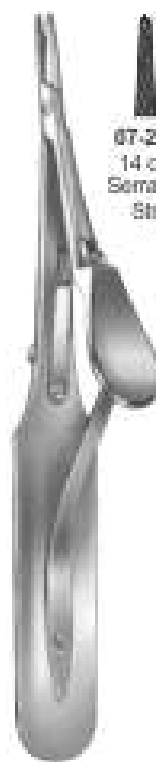
07-215
 10 cm
 07-216
 11.5 cm
 Smooth
 Cvd.



Kalt Needle Holders



07-217
 14 cm
 Serrated



Arruga Needle Holders

07-218
 14 cm
 Serrated
 Str.

07-219
 14 cm
 Serrated
 Cvd.



07-220 14 cm
07-221 18 cm
07-222 20 cm
07-223 23 cm
07-224 25 cm

**Microvascular
Needle Holders T.C.**



07-225
15 cm
07-226
18 cm
07-227
20 cm

**Micro Ryder Needle
Holders T.C.**



07-228
13 cm
07-229
15 cm
07-230
18 cm
07-231
20 cm
07-232
22 cm
07-233
25 cm

**Crile-Wood Needle
Holders T.C.**



07-234
18 cm
07-235
20 cm
07-236
22 cm
07-237
25 cm

Intracardiac Needle Holders T.C.

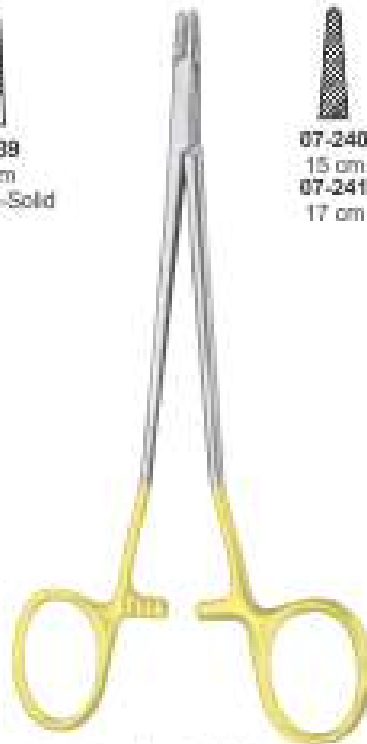


07-238
18 cm

**New Orleans Needle
Holders T.C.**



07-239
18 cm
Serrated-Solid



07-240
15 cm
07-241
17 cm

**Senning Needle Holders T.C.
(Schwed. Model)**

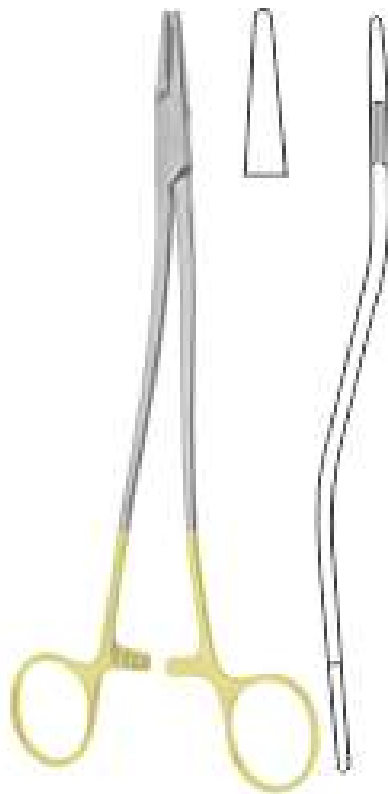


07-242
15 cm
Serrated-Solid

Carroll Needle Holders T.C.

NEEDLE HOLDERS T.C.

Needleholder | Porta-agujas
 Prote-ajujles | Porta aghi



Wertheim Needle Holders T.C
 07-243 20 cm
 07-244 24 cm



Kilner Needle Holders T.C

07-245
13 cm



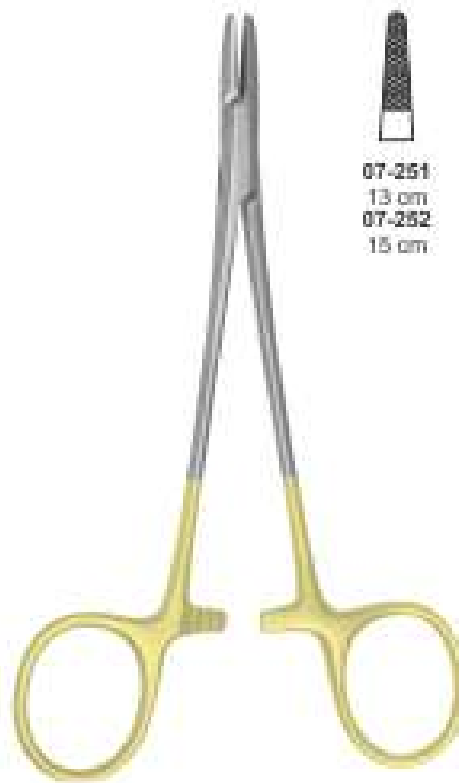
Jacobson Needle Holders T.C

07-246
18 cm



Bozemann Needle Holders T.C

07-247
20 cm
 07-248
24 cm
 07-249
26 cm
 07-250
30 cm



Baumgartner Needle Holders T.C

07-251
13 cm
 07-252
15 cm



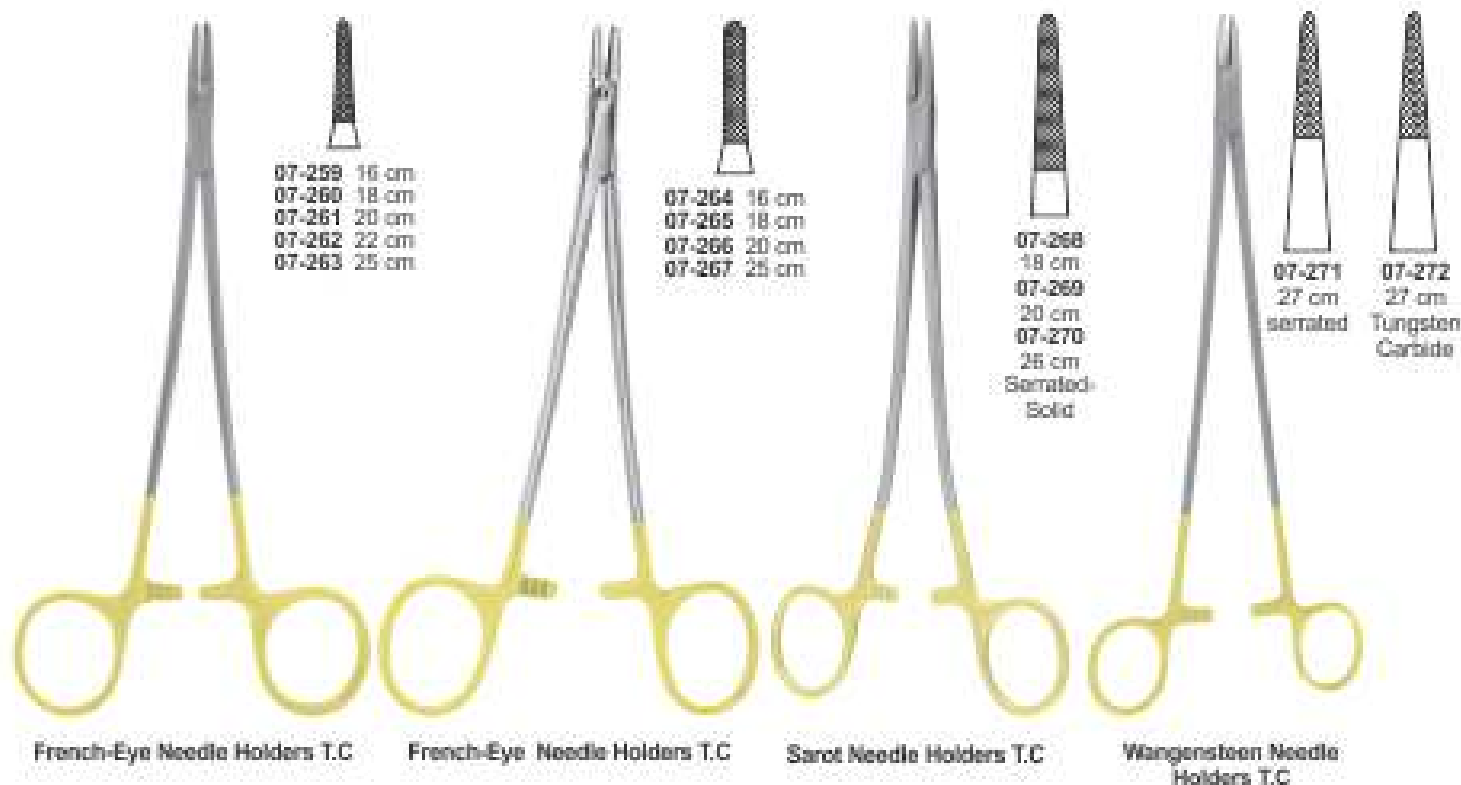
Olsen-Hegar Needle Holders T.C

07-253 14 cm	07-256 14 cm
07-254 17 cm	07-257 17 cm
07-255 19 cm Serrated-Solid	07-258 19 cm Serrated-Solid

NEEDLE HOLDERS T.C.

Nadelhalter
Prote-agulhas

Porta-agulhas
Porta aghi



NEEDLE HOLDERS T.C.



Nadelhalter | Porta-agujas
 Prote-agulles | Porta aghi



07-298
 20 cm
 Curved



07-299
 18 cm



07-300 20 cm
07-301 23 cm
07-302 25 cm
 Curved

07-303 20 cm
07-304 23 cm
07-305 25 cm
 Curved

Finochietto Needle Holders T.C

Rochester Needle Holders T.C

Stratte Needle Holders T.C



07-306
 16 cm



07-307 12.5 cm
 Smooth

07-308 12.5 cm
 Serrated-Solid

07-309 12.5 cm
 Tungsten Carbide
 Smooth

07-310 12.5 cm
 Tungsten Carbide
 Serrated-Solid




07-311
 14 cm
 Serrated-Delicate

Gillies Needle Holders T.C

Halsey Needle Holders T.C

Eufrate Pasque T.C
 Needle Holders



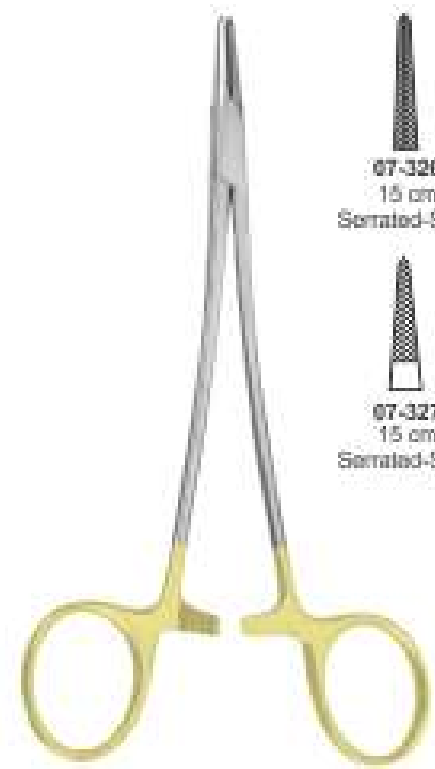
- | | |
|---|---|
|  |  |
| 07-312
12.5 cm | 07-317
12.5 cm |
| 07-313
15 cm | 07-318
15 cm |
| 07-314
18 cm | 07-319
18 cm |
| 07-315
20 cm | 07-320
20 cm |
| 07-316
23 cm | 07-321
23 cm |
- Smooth inserts.

Ryder Needle Holders T.C
Narrow jaws.



- | |
|---|
|  |
| 07-322
18 cm |
| 07-323
20 cm |
| 07-324
23 cm |
| 07-325
26 cm |

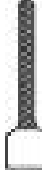
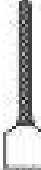
Cooley Intracardiac Needle Holders T.C
Narrow Jaw.



- | |
|---|
|  |
| 07-326
15 cm
Serrated-Solid |
|  |
| 07-327
15 cm
Serrated-Solid |

Baby Crile-Wood Needle Holders T.C



- | | |
|---|---|
|  |  |
| 07-328
13 cm | 07-334
13 cm |
| 07-329
15 cm | 07-335
16 cm |
| 07-330
18 cm | 07-336
18 cm |
| 07-331
20 cm | 07-337
20 cm |
| 07-332
23 cm | 07-338
23 cm |
| 07-333
26 cm | Serrated-Micro |
- Serrated-Solid

Ryder French-Eye/Standard/Micro Needle Holders T.C



- | |
|---|
|  |
| 07-339
12.5 cm
Tungsten Carbide
Serrated-Solid |

Converse Needle Holders



- | |
|---|
|  |
| 07-340
12 cm
Tungsten Carbide
Serrated-Solid |

Derf Needle Holders T.C

NEEDLE HOLDERS T.C.

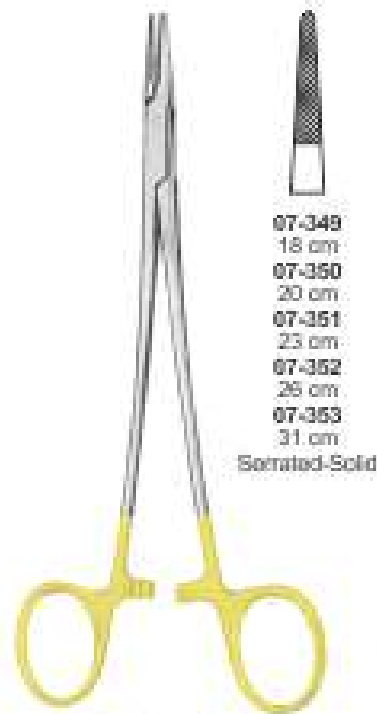
Nadelhalter | Porta-agujas
 Prote-agulhas | Porta aghi



De Bakay Needle Holders T.C
 07-341 18 cm
 07-342 20 cm
 07-343 22 cm
 07-344 25 cm



Debakay Cardiovascular Needle Holders T.C
 Delicate patterns, serrated.



Debakay-Vascular/Extra Light Needle Holders T.C

- 07-345 18 cm
 - 07-346 23 cm
 - 07-347 25 cm
 - 07-348 30 cm
 - 07-349 18 cm
 - 07-350 20 cm
 - 07-351 23 cm
 - 07-352 26 cm
 - 07-353 31 cm
- Serrated-Solid



Gillies Slim T.C. Needle Holders with Scissors

07-354
15cm



Wire Twisters Needle Holders T.C

07-355
15 cm
Delicate.

07-356 15 cm
 07-357 18 cm
 07-358 20 cm
 Heavy



Sternum Needle Holders T.C

07-359
18 cm
Wire Twister



Cooley-Baumgarten Wire Twister Needle Holders T.C
 Extra heavy needle holder designed for twisting of wire and placement of retention suture. Heavy, blunt jaws.

07-360
20 cm

NEEDLE HOLDERS T.C.

Nadelhafter | Porta-agujas
 Prote-aguilles | Porta aghi



07-361
12.5 cm

**Rubio Wire Twister
Needle Holders T.C**



07-362
12.5 cm

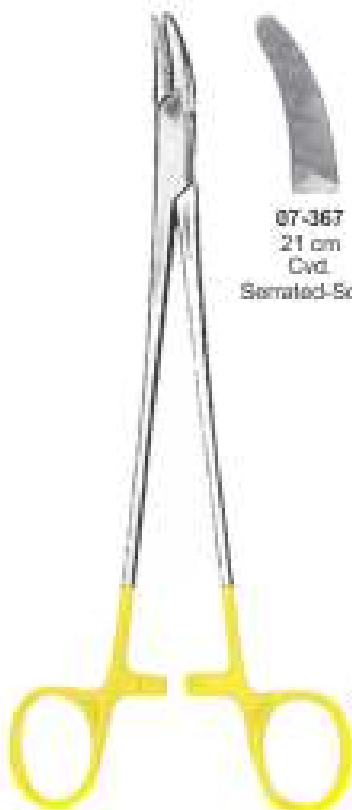
Neivert Needle Holders T.C



07-363
13 cm
Smooth
07-364
15 cm
Smooth

07-365
13 cm
07-366
15 cm

Webster Needle Holders T.C



07-367
21 cm
Cvd.
Serrated-Solid

07-369
26 cm
Cvd.
Tungsten
Carbide
Serrated-Solid

Heaney-Gyne Needle Holders T.C



07-368
24 cm
Cvd.
Tungsten
Carbide
Serrated-Solid

**Wire Tightening
Needle Holders T.C**
07-370 18 cm



07-371
20 cm
Straight

07-372
20 cm
Curved

Julian Needle Holders T.C

NEEDLE HOLDERS T.C.

Nadelhalter | Porta-agujas
 Prote-agulles | Porta aghi



07-373
27 cm

07-374
30 cm

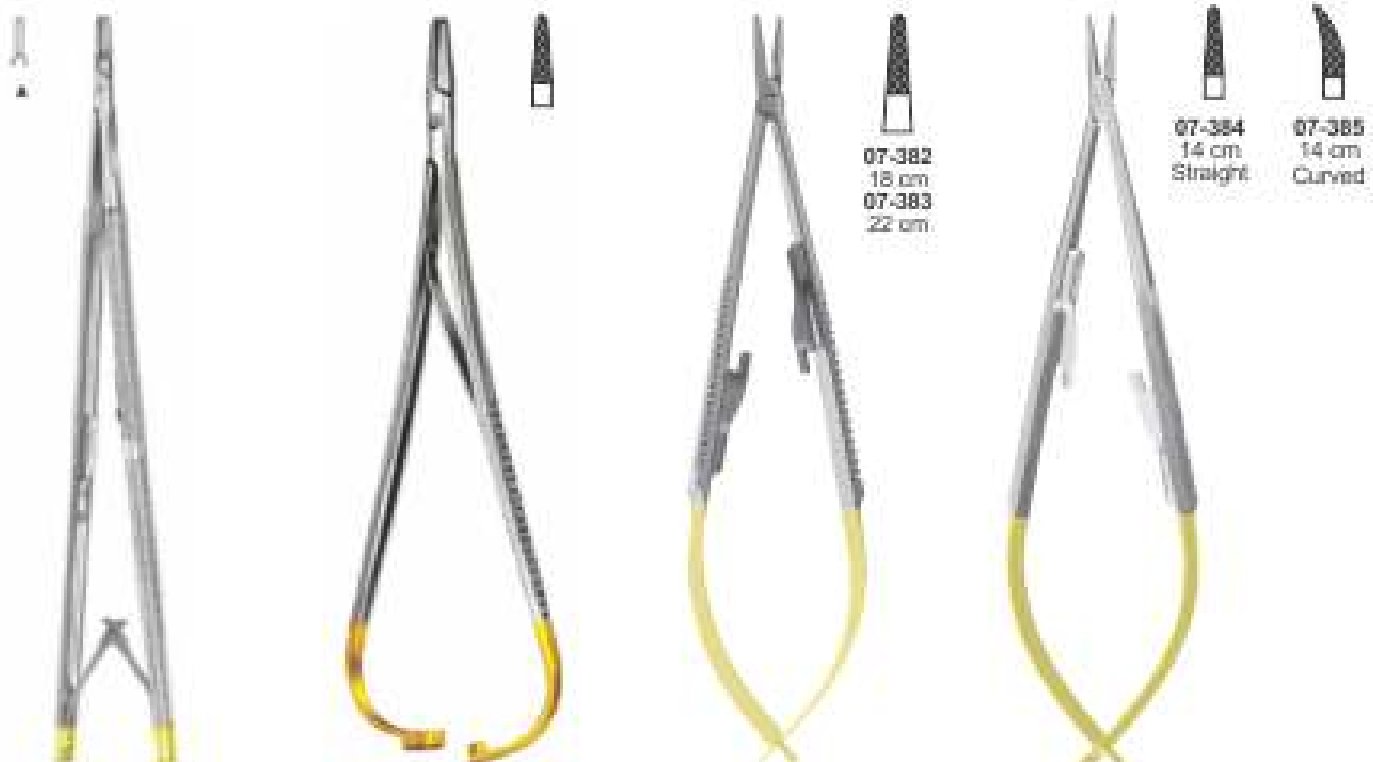
07-375
15 cm
07-376
17 cm
07-377
20 cm

07-378
20 cm
07-379
25 cm

Masson Needle Holders T.C O'Brien Needle Holders T.C

Martin Needle Holder mini profile elastic type

Thomson-Walker Needle Holders T.C



07-382
18 cm
07-383
22 cm

07-384
14 cm
Straight

07-385
14 cm
Curved

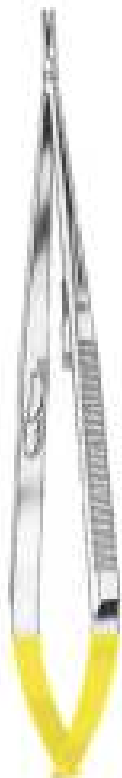
Hopp-Scheidt
07-380
Micro Needle Holder smooth jaw
18 cm,

Lichtenberg
07-381 - 20 cm
Needle Holder lightweight model
standard profile

Castroviejo Needle Holders T.C

Castroviejo Needle Holders T.C

Nadelhafter | *Porta-agujas*
Prote-aguilles | *Porta aghi*

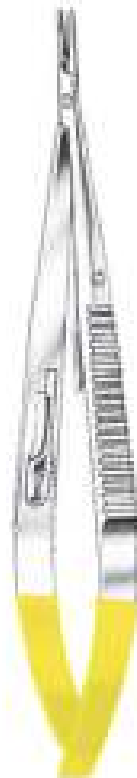


07-386
18 cm
Smooth

07-388
21 cm
Smooth

07-387
21 cm
Smooth

07-389
21 cm
Serrated-Solid



07-390
14 cm
Straight
Smooth
fine tip

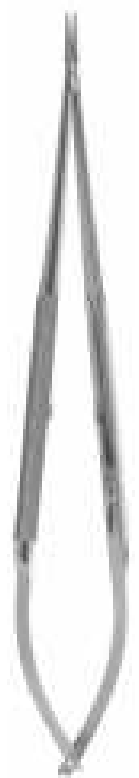
07-394
14 cm
07-395
18 cm
Straight
Serrated-Solid
fine tip

07-391
14 cm
Curved
Smooth
fine tip

07-396
14 cm
07-397
18 cm
Curved
Serrated-Solid
fine tip

07-392
14 cm
Straight
Serrated-Solid
fine tip

07-393
14 cm
Straight
Smooth
regular tip



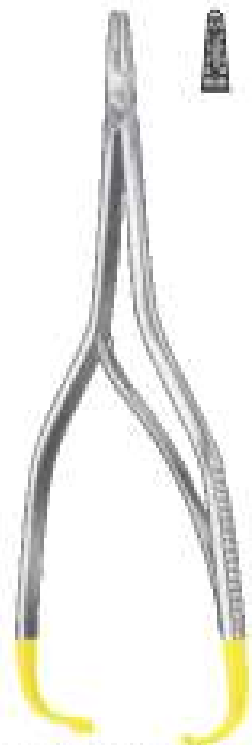
Micro Needle Holder
07-398 16 cm
07-399 18 cm
07-400 21 cm
07-401 23 cm

**Jacobson
Needle Holders T.C**

**Castroviejo
Needle Holders T.C**



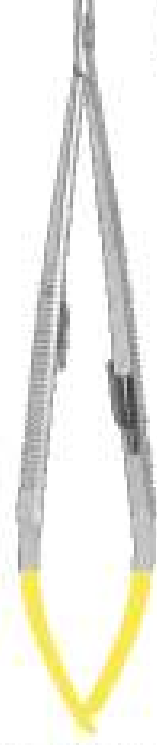
Toennis Needle Holders T.C
07-402 18.5 cm



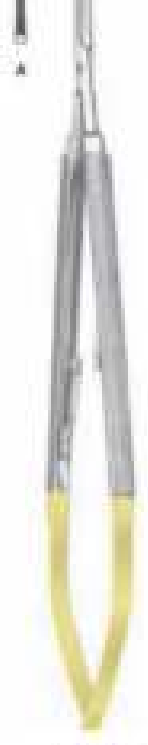
Boynton Needle Holders T.C
07-403 12 cm



Arruga Needle Holders T.C
07-404 16 cm Str.
07-405 16 cm Cvd.



**Spencer Coronary
Needle Holders T.C**
07-406 18 cm



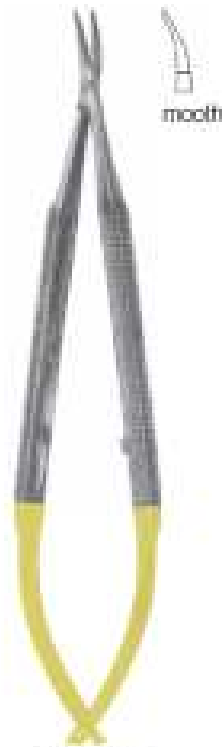
**Jaboma
07-407
Micro Needle Holder**
18 cm

NEEDLE HOLDERS T.C.

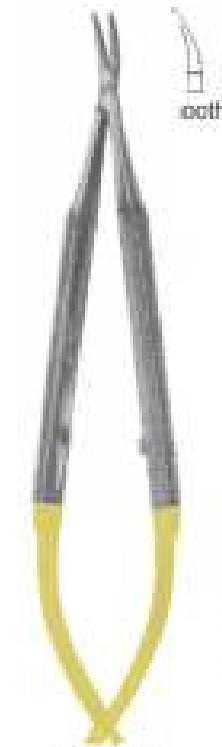
Nadelhalter | Porta-agujas
 Prote-aguilles | Porta aghi



Castroviejo Micro Needle Holder
 07-408 14.5 cm
 07-409 18 cm
 07-410 21.5 cm



Barraquer Micro Needle Holder
 07-411 13 cm



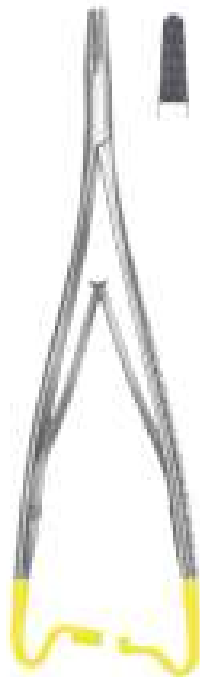
Barraquer Micro Needle Holder
 07-412 13 cm



Mathieu Needle Holder
 07-413 14 cm
 07-414 17 cm
 07-415 20 cm



Mathieu Needle Holder
 07-416 14 cm
 07-417 17 cm
 07-418 20 cm



Mathieu Needle Holder
 07-419 17 cm
 07-420 20 cm
 07-421 23 cm
 standard profile with interior ratchet



Castroviejo Micro Needle Holder
 07-422 12.5 cm



Kalt Needle Holders T.C
 07-423 14 cm Str.



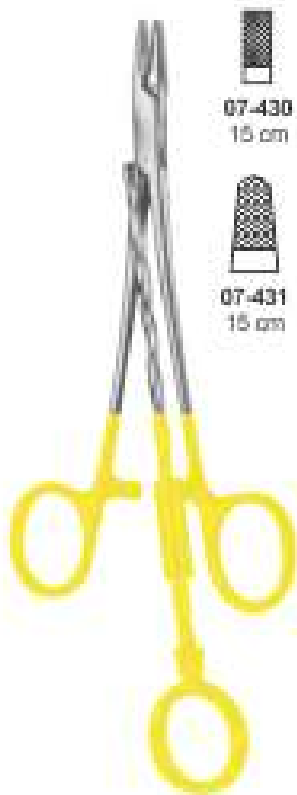
Mathieu-Ryder Needle Holders T.C

07-424 17 cm
 07-425 20 cm
 07-426 24 cm



Mathieu-Ryder Vascular Needle Holders T.C

07-427 17 cm
 07-428 20 cm
 07-429 24 cm



07-430
15 cm

07-432
17 cm

07-431
15 cm

Corwin Needle Holders T.C



07-433
20 cm

Lichtenberg Needle Holders T.C



Langenbeck
Needle
Holders T.C
07-434
15 cm
07-435
18 cm
07-436
20 cm

Langenbeck-
Delicate
Needle
Holders T.C
07-437
18 cm
07-438
20 cm
07-439
23 cm

Langenbeck-
Ryder
Needle
Holders T.C
07-440
18 cm
07-441
20 cm
07-442
23 cm



07-443
20 cm



07-444
23 cm

Zwiefel Needle Holders T.C



07-445
18.5 cm

Eiselsberg-Matheu
Needle Holders T.C

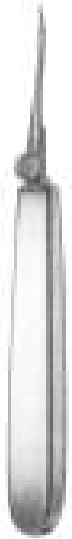


07-446
20 cm

Luetthy-Beck
Needle Holders T.C

Reverdin nadeln
aguja de reverdin

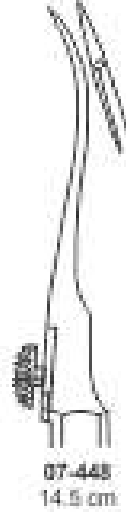
Aguilles de reverdin
aghi di reverdin



Reverdin Needle
short



07-447
14.5 cm



07-448
14.5 cm



07-449
14.5cm



07-450
14.5cm



21cm



2
07-451



1
07-452



4
07-453



3
07-454



Reverdin Needle
19.5 cm



07-455
19.5cm
07-456
23cm



07-457
19.5cm
07-458
23cm



07-459
19.5cm
07-460
23cm



07-461
19.5cm
07-462
23cm



Reverdin Needle
23 cm



07-463
25cm



07-464
23cm
07-465
28cm



König
07-466
20 cm

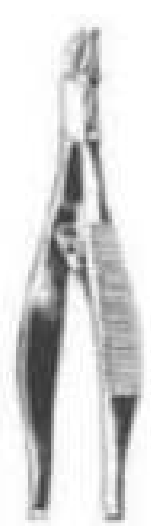


Payr
07-467
22 cm



König Ligature
Conductor

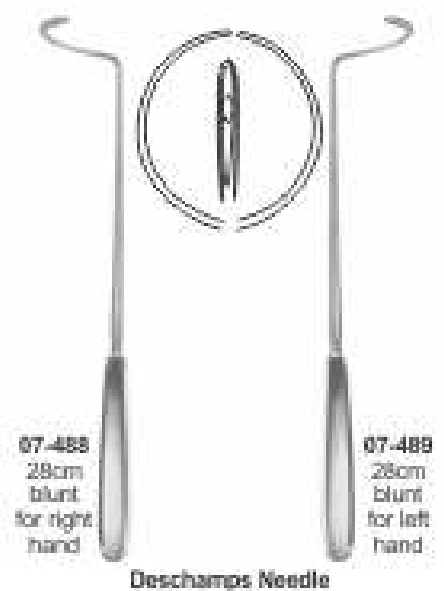
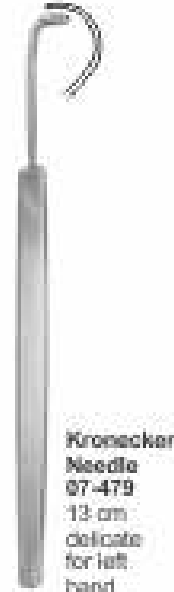
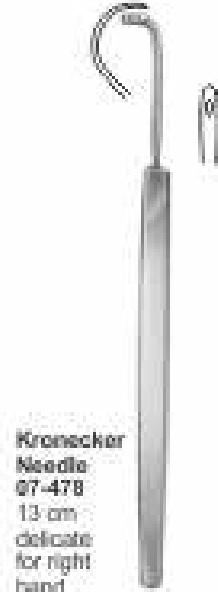
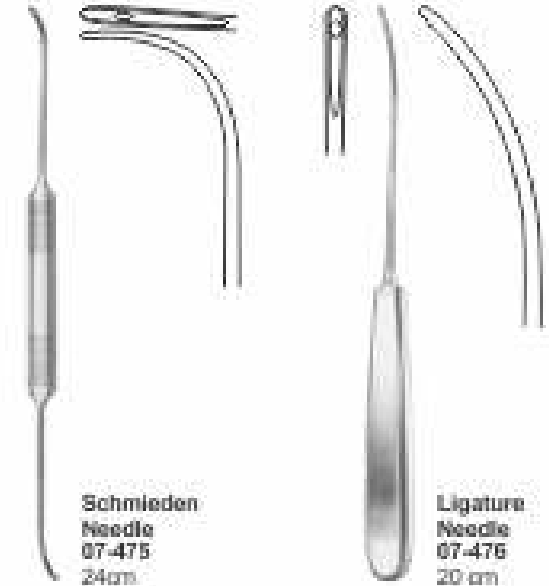
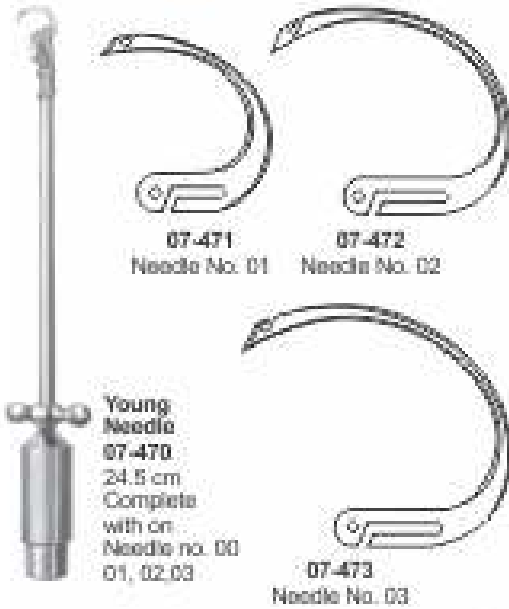
07-468
19.5cm
/ 3 mm



Michel
07-469

Reverdin nađeln
agujas de reverdin

Aguilles de reverdin
aghi di reverdin



LIGATURE NEEDLES

Unterbindungsnadeln
agujas para ligaduras

Agiulles à ligatures
aghi di legatura



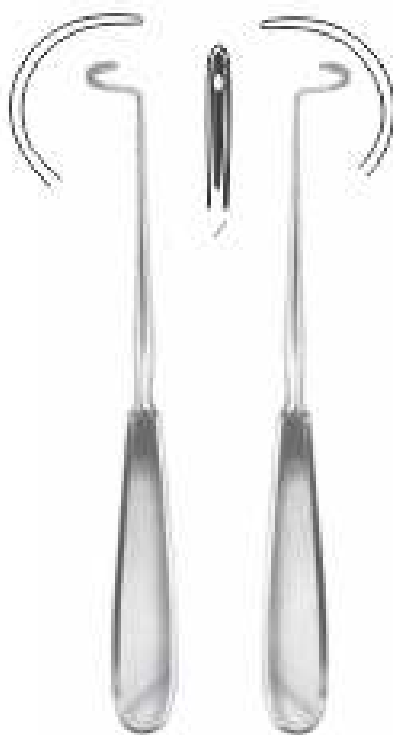
Deschamps Needle
07-490 20cm sharp for right hand
07-491 20cm sharp for left hand



Deschamps Needle
07-492 20cm blunt for right hand
07-493 20cm blunt for left hand



Deschamps Needle
07-494 21cm blunt for right hand
07-495 21cm blunt for left hand



Deschamps Needle
07-496 20cm blunt for right hand
07-497 20cm blunt for left hand



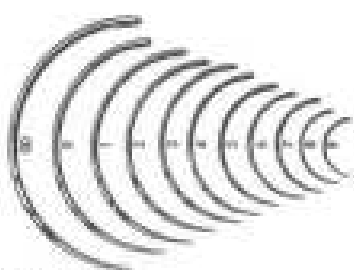
Deschamps Needle
07-498 20cm sharp for right hand
07-499 20cm sharp for left hand



Deschamps Needle
07-500 20cm blunt for right hand
07-501 20cm blunt for left hand

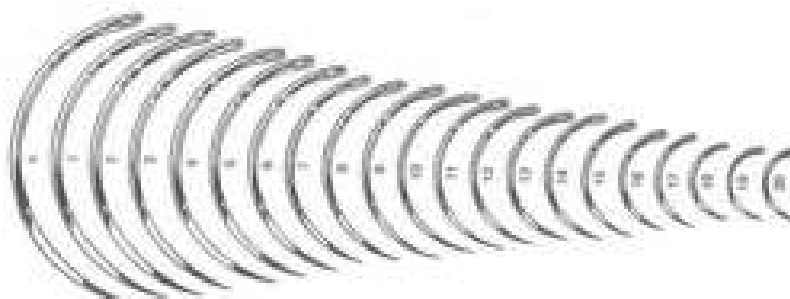
Reverdin needle
aguja de reverdin

Aguilles de reverdin
aghi di reverdin

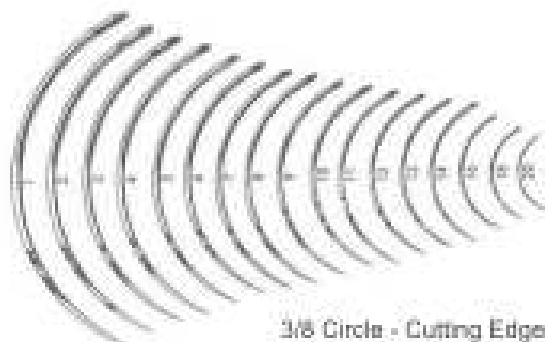


SURGEONS NEEDLES

- 07-502 Fistula Needle, 1/2 Circle, Cutting Edge, #00
- 07-503 Fistula Needle, 1/2 Circle, Cutting Edge, #0
- 07-504 Fistula Needle, 1/2 Circle, Cutting Edge, #1
- 07-505 Fistula Needle, 1/2 Circle, Cutting Edge, #2
- 07-506 Fistula Needle, 1/2 Circle, Cutting Edge, #3
- 07-507 Fistula Needle, 1/2 Circle, Cutting Edge, #4
- 07-508 Fistula Needle, 1/2 Circle, Cutting Edge, #5
- 07-509 Fistula Needle, 1/2 Circle, Cutting Edge, #6
- 07-510 Fistula Needle, 1/2 Circle, Cutting Edge, #7
- 07-511 Fistula Needle, 1/2 Circle, Cutting Edge, #8
- 07-512 Fistula Needle, 1/2 Circle, Cutting Edge, #9



- 07-513 Regular Surgeons Needle, 1/2 Circle, Cutting Edge, #0
- 07-514 Regular Surgeons Needle, 1/2 Circle, Cutting Edge, #1
- 07-515 Regular Surgeons Needle, 1/2 Circle, Cutting Edge, #2
- 07-516 Regular Surgeons Needle, 1/2 Circle, Cutting Edge, #3
- 07-517 Regular Surgeons Needle, 1/2 Circle, Cutting Edge, #4
- 07-518 Regular Surgeons Needle, 1/2 Circle, Cutting Edge, #5
- 07-519 Regular Surgeons Needle, 1/2 Circle, Cutting Edge, #6
- 07-520 Regular Surgeons Needle, 1/2 Circle, Cutting Edge, #7
- 07-521 Regular Surgeons Needle, 1/2 Circle, Cutting Edge, #8
- 07-522 Regular Surgeons Needle, 1/2 Circle, Cutting Edge, #9
- 07-523 Regular Surgeons Needle, 1/2 Circle, Cutting Edge, #10
- 07-524 Regular Surgeons Needle, 1/2 Circle, Cutting Edge, #11
- 07-525 Regular Surgeons Needle, 1/2 Circle, Cutting Edge, #12
- 07-526 Regular Surgeons Needle, 1/2 Circle, Cutting Edge, #13
- 07-527 Regular Surgeons Needle, 1/2 Circle, Cutting Edge, #14
- 07-528 Regular Surgeons Needle, 1/2 Circle, Cutting Edge, #15
- 07-529 Regular Surgeons Needle, 1/2 Circle, Cutting Edge, #16
- 07-530 Regular Surgeons Needle, 1/2 Circle, Cutting Edge, #17
- 07-531 Regular Surgeons Needle, 1/2 Circle, Cutting Edge, #18
- 07-532 Regular Surgeons Needle, 1/2 Circle, Cutting Edge, #19
- 07-533 Regular Surgeons Needle, 1/2 Circle, Cutting Edge, #20



3/8 Circle - Cutting Edge

SURGEONS NEEDLES

- 07-534 Regular Surgeons Needle, 3/8 Circle, Cutting Edge, #1
- 07-535 Regular Surgeons Needle, 3/8 Circle, Cutting Edge, #2
- 07-536 Regular Surgeons Needle, 3/8 Circle, Cutting Edge, #3
- 07-537 Regular Surgeons Needle, 3/8 Circle, Cutting Edge, #4
- 07-538 Regular Surgeons Needle, 3/8 Circle, Cutting Edge, #5
- 07-539 Regular Surgeons Needle, 3/8 Circle, Cutting Edge, #6
- 07-540 Regular Surgeons Needle, 3/8 Circle, Cutting Edge, #7
- 07-541 Regular Surgeons Needle, 3/8 Circle, Cutting Edge, #8
- 07-542 Regular Surgeons Needle, 3/8 Circle, Cutting Edge, #9
- 07-543 Regular Surgeons Needle, 3/8 Circle, Cutting Edge, #10
- 07-544 Regular Surgeons Needle, 3/8 Circle, Cutting Edge, #11
- 07-545 Regular Surgeons Needle, 3/8 Circle, Cutting Edge, #12
- 07-546 Regular Surgeons Needle, 3/8 Circle, Cutting Edge, #13
- 07-547 Regular Surgeons Needle, 3/8 Circle, Cutting Edge, #14
- 07-548 Regular Surgeons Needle, 3/8 Circle, Cutting Edge, #15
- 07-549 Regular Surgeons Needle, 3/8 Circle, Cutting Edge, #16
- 07-550 Regular Surgeons Needle, 3/8 Circle, Cutting Edge, #17
- 07-551 Regular Surgeons Needle, 3/8 Circle, Cutting Edge, #18
- 07-552 Regular Surgeons Needle, 3/8 Circle, Cutting Edge, #19
- 07-553 Regular Surgeons Needle, 3/8 Circle, Cutting Edge, #20

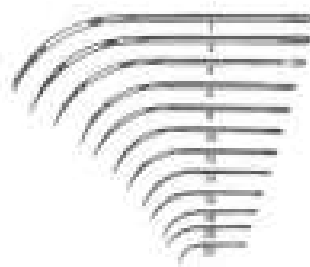
SURGEONS NEEDLES

- 07-554 Regular Surgeons Needles, 1/2 Curved, Cutting Edge, #0
- 07-555 Regular Surgeons Needles, 1/2 Curved, Cutting Edge, #1
- 07-556 Regular Surgeons Needles, 1/2 Curved, Cutting Edge, #2
- 07-557 Regular Surgeons Needles, 1/2 Curved, Cutting Edge, #4
- 07-558 Regular Surgeons Needles, 1/2 Curved, Cutting Edge, #6
- 07-559 Regular Surgeons Needles, 1/2 Curved, Cutting Edge, #8
- 07-560 Regular Surgeons Needles, 1/2 Curved, Cutting Edge, #10
- 07-561 Regular Surgeons Needles, 1/2 Curved, Cutting Edge, #12
- 07-562 Regular Surgeons Needles, 1/2 Curved, Cutting Edge, #14
- 07-563 Regular Surgeons Needles, 1/2 Curved, Cutting Edge, #16
- 07-564 Regular Surgeons Needles, 1/2 Curved, Cutting Edge, #20
- 07-565 Regular Surgeons Needles, 1/2 Curved, Cutting Edge, #22



Keith Abdominal Straight, Triangular Point

- 07-566 Keith Abdominal Needles, Straight, Triangular Point, 4"
- 07-567 Keith Abdominal Needles, Straight, Triangular Point, 3-1/2"
- 07-568 Keith Abdominal Needles, Straight, Triangular Point, 3"
- 07-569 Keith Abdominal Needles, Straight, Triangular Point, 2-7/8"
- 07-570 Keith Abdominal Needles, Straight, Triangular Point, 2-1/8"
- 07-571 Keith Abdominal Needles, Straight, Triangular Point, 2"
- 07-572 Keith Abdominal Needles, Straight, Triangular Point, 1-3/4"
- 07-573 Keith Abdominal Needles, Straight, Triangular Point, 1-1/2"



half Curved - Cutting Edge

*Reverdin needle
aguja de reverdin*

*Aguilles de reverdin
aghi di reverdin*

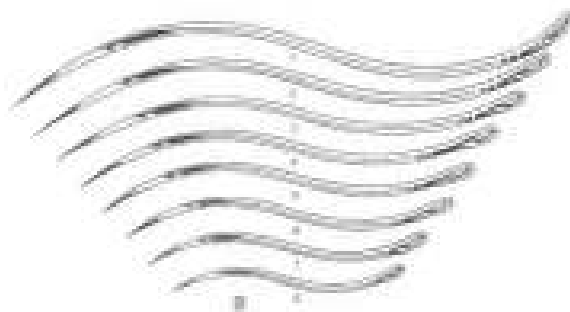


- 07-574 Regular Surgeons Needles, 1/2 Curved, Tapered Point, #2
- 07-575 Regular Surgeons Needles, 1/2 Curved, Tapered Point, #4
- 07-576 Regular Surgeons Needles, 1/2 Curved, Tapered Point, #6
- 07-577 Regular Surgeons Needles, 1/2 Curved, Tapered Point, #8
- 07-578 Regular Surgeons Needles, 1/2 Curved, Tapered Point, #10
- 07-579 Regular Surgeons Needles, 1/2 Curved, Tapered Point, #12
- 07-580 Regular Surgeons Needles, 1/2 Curved, Tapered Point, #14
- 07-581 Regular Surgeons Needles, 1/2 Curved, Tapered Point, #16
- 07-582 Regular Surgeons Needles, 1/2 Curved, Tapered Point, #18
- 07-583 Regular Surgeons Needles, 1/2 Curved, Tapered Point, #20
- 07-584 Regular Surgeons Needles, 1/2 Curved, Tapered Point, #22



SURGEONS NEEDLES 3/8 circle - cutting edge

- A** 07-585 Veterinary Needles, 3/8 Circle, Cutting Edge, #1
- 07-586 Veterinary Needles, 3/8 Circle, Cutting Edge, #2
- 07-587 Veterinary Needles, 3/8 Circle, Cutting Edge, #3
- 07-588 Veterinary Needles, 3/8 Circle, Cutting Edge, #4
- 07-589 Veterinary Needles, 3/8 Circle, Cutting Edge, #5
- 07-590 Veterinary Needles, 3/8 Circle, Cutting Edge, #6
- 07-591 Veterinary Needles, 3/8 Circle, Cutting Edge, #7
- 07-592 Veterinary Needles, 3/8 Circle, Cutting Edge, #8



double curved - cutting edge

- B** 07-593 Post Mortem Needles, Double Curve Cutting Edge, Size 1
- 07-594 Post Mortem Needles, Double Curve Cutting Edge, Size 2
- 07-595 Post Mortem Needles, Double Curve Cutting Edge, Size 3
- 07-596 Post Mortem Needles, Double Curve Cutting Edge, Size 4
- 07-597 Post Mortem Needles, Double Curve Cutting Edge, Size 5
- 07-598 Post Mortem Needles, Double Curve Cutting Edge, Size 6
- 07-599 Post Mortem Needles, Double Curve Cutting Edge, Size 7
- 07-600 Post Mortem Needles, Double Curve Cutting Edge, Size 8

SURGEONS NEEDLES

- A** 07-601 Martin Uterine Needles, 1/2 Curved Cutting Edge, #1
- 07-602 Martin Uterine Needles, 1/2 Curved Cutting Edge, #2
- 07-603 Martin Uterine Needles, 1/2 Curved Cutting Edge, #3
- 07-604 Martin Uterine Needles, 1/2 Curved Cutting Edge, #4
- 07-605 Martin Uterine Needles, 1/2 Curved Cutting Edge, #5
- 07-606 Martin Uterine Needles, 1/2 Curved Cutting Edge, #6
- 07-607 Martin Uterine Needles, 1/2 Curved Cutting Edge, #7
- 07-608 Martin Uterine Needles, 1/2 Curved Cutting Edge, #8
- B** 07-609 Lane Cleft Palate, 1/2 Circle, Cutting Edge, #1
- 07-610 Lane Cleft Palate, 1/2 Circle, Cutting Edge, #2
- 07-611 Lane Cleft Palate, 1/2 Circle, Cutting Edge, #3
- 07-612 Lane Cleft Palate, 1/2 Circle, Cutting Edge, #4
- 07-613 Lane Cleft Palate, 1/2 Circle, Cutting Edge, #5
- C** 07-614 Post Mortem Needles, Half Curved Cutting Edge, Size 1
- 07-615 Post Mortem Needles, Half Curved Cutting Edge, Size 2
- 07-616 Post Mortem Needles, Half Curved Cutting Edge, Size 3
- 07-617 Post Mortem Needles, Half Curved Cutting Edge, Size 4
- 07-618 Post Mortem Needles, Half Curved Cutting Edge, Size 5
- 07-619 Post Mortem Needles, Half Curved Cutting Edge, Size 6



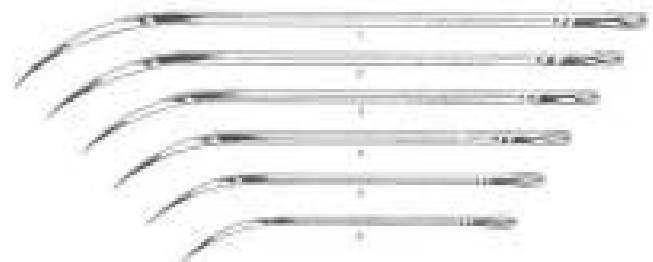
Martin, 1/2 Circle Cutting Edge

A



Left Cleft Palate, 1/2 Circle Cutting Edge

B



Post Mortem - Half Curved Cutting Edge

C

RETRACTORS INSTRUMENTS



HOKKLET & SKIN HOOKS



Wundhaken, Mikrohaken | Crachet, Micro crachetes
 Ganchito, Micro Ganchitos | Divaricatori, Micro Divaricatori



08-001
16 cm, 8 1/2"
large curve

08-002
16 cm, 6 1/2"
small curve

GUTHRIE HOOKLET



08-003
18 cm, 7"
Sharp

08-004
18 cm, 7"
sharp

GILLIES SKIN HOOK



08-005
16 cm, 6"
sharp

KILNER HOOK



08-006
18.5 cm, 7 1/2"
sharp

08-007
18.5 cm, 7 1/2"
sharp

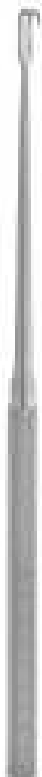
FISCH HOOKLET & Skin Hook



08-008
13 cm, 5"
08-009
18 cm, 7"
Blunt

08-010
13 cm, 5"
08-011
18 cm, 7"
Sharp

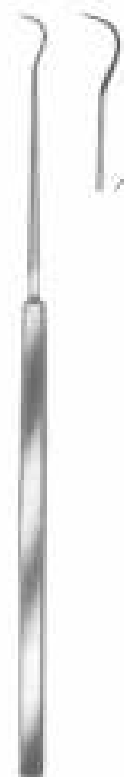
FRAZIER HOOKLET & Skin Hook



DOUBLE PRONG MICRO HOOK & Skin Hook
08-012
Sharp, 2mm, wide jaws,
14.5 cm, 6 1/2"



WIENER HOOK & Skin Hook
08-013
Sharp,
14 cm, 5 1/2"



TOENNIS HOOK & Skin Hook
08-014
15 cm, 6"
Sharp



08-015
2 sharp prong
13 cm, 5"
2.25mm diameter
3mm wide

08-016
4 sharp prong
13 cm, 5"
2mm diameter
5mm wide

08-017
4 blunt prong
13 cm, 5"
2mm diameter
5mm wide

ROLLET HOOK



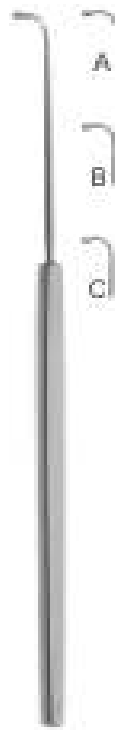
08-018
15 cm, 6", sharp
double prongs
2.5mm wide

08-019
15 cm, 6", blunt
double prongs
2.5mm wide

FREER SKIN HOOK



CRILE HOOKLET & SKIN HOOKS
08-020 20.4 cm, 8"



VON GRAEFE Strabismus & SKIN HOOKS
08-021 13.0 cm, 5" - A
08-022 14.0 cm, 5 1/2" - B
08-023 15.0 cm, 6" - C



WAGENER HOOKLET & SKIN HOOKS
08-024 14 cm, 5 1/2" - A
08-025 14 cm, 5 1/2" - B
08-026 14 cm, 5 1/2" - C
08-027 14 cm, 5 1/2" - D



DAY HOOKLET & SKIN HOOKS
08-028 16 cm, 6 1/2" - A
08-029 16 cm, 6 1/2" - B



LUCAE HOOKLET & SKIN HOOKS
08-030 14 cm, 5 1/2" - A
08-031 14 cm, 5 1/2" - B
08-032 14 cm, 5 1/2" - C



Converse Hook
08-033
12 cm, 5"



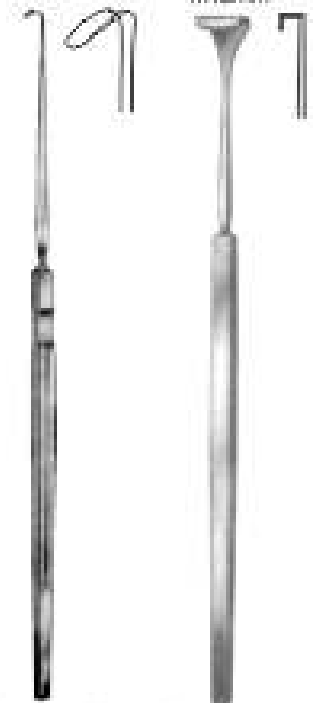
MANNERFELT-LANGENBECK HOOK
08-034 15 x 6 mm 15.5 cm, 6" Fig.1
08-035 20 x 6 mm 15.5 cm, 6" Fig.2
08-036 25 x 6 mm 15.5 cm, 6" Fig.3
08-037 30 x 8 mm 15.5 cm, 6" Fig.4



MANNERFELT HOOK
15.5 cm, 6"
large curve, single
hook



Brom Hooklet Retractors
08-041
17 cm, 6 3/4"



Hooklet Retractors
08-042
13 cm, 5"

HOOKLET, RETRACTORS

Wundhäkchen, Wundhaken
Ganchito, Separadores

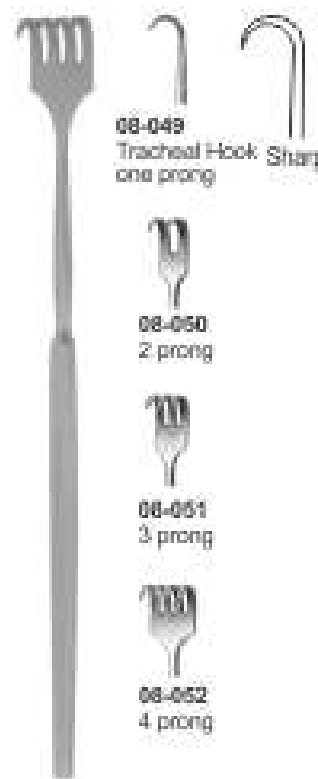
Crochet, Ecarteurs
Divaricatore, Divaricatori



Tracheal Retractor
18 cm



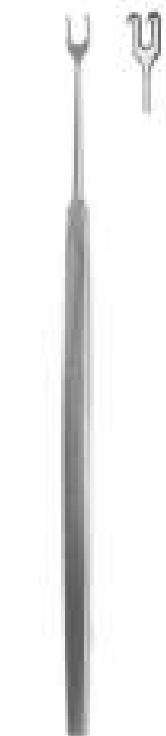
Tracheal Retractor
18 cm



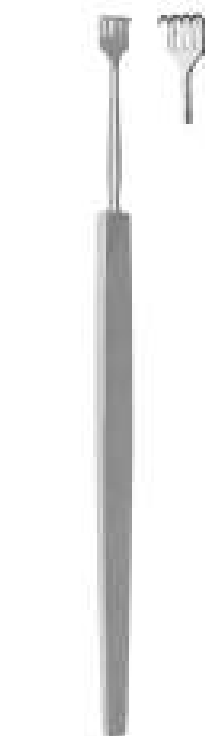
Trachea Retractor
18.5 cm Sharp



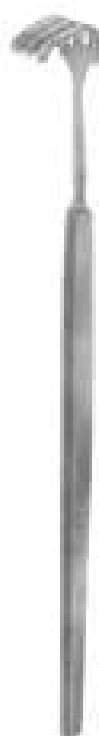
Tracheal Retractor
16.5 cm Blunt



Roller Hooklet
Retractors
08-057
12.5cm



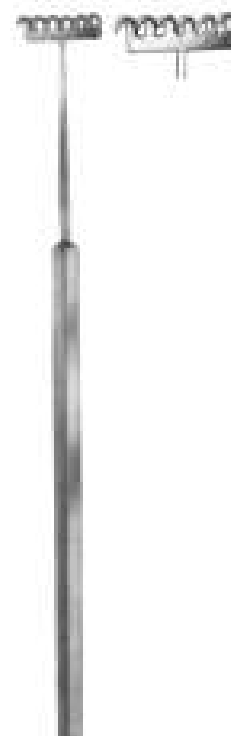
Roller (Blair)
Hooklet Retractors
08-058
13.5cm



Paul Hooklet
Retractors
08-059
12.5cm



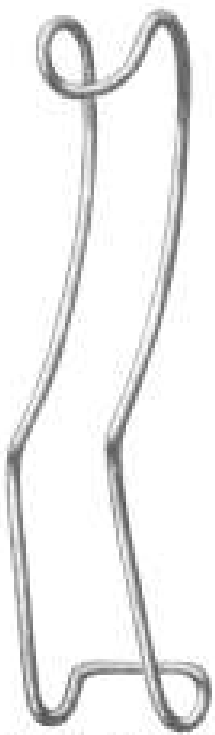
Paul Hooklet
Retractors
08-060
16cm



Miller Retractor
08-061
13.5cm
Sharp 6 prong



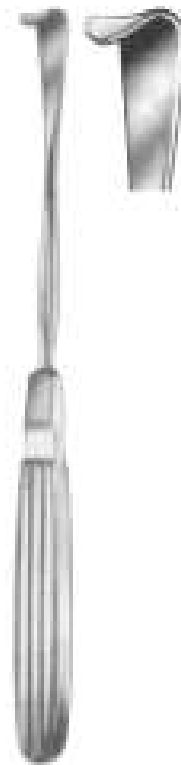
Miller Retractor
13.5 cm



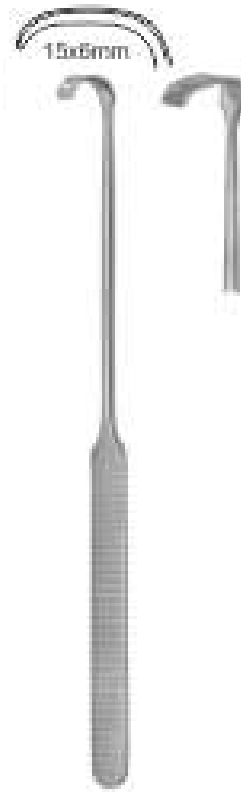
Sternberg Retractor
08-113 12 cm, 4 3/4"
08-114 14 cm, 5 1/2"
08-115 16 cm, 6 1/4"



Collin-Hartmann Retractor
08-116
38 x 28 / 32 x 21 mm 14 cm, 5 1/2"
08-117
52 x 34 / 36 x 27 mm 16 cm, 6 1/4"



Herzfeld Retractor
08-118
20 cm, 8"



Strandell-Stille Retractor
08-119
19 cm, 7 1/2"



Strandell-Stille Retractor
08-120
19 cm, 7 1/2"



Schoenborn Retractor
08-121
21 cm, 8 1/4"



König Retractor
17 cm, 6 3/4"



08-122
13 x 13 mm

08-123
12 x 16 mm

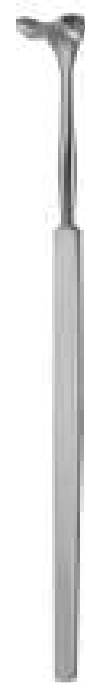


Senn-Green Retractor
15 cm, 6"

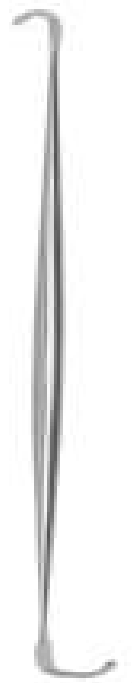


08-124
10 x 6 mm

08-125
20 x 6 mm



Cottle Retractor
08-126
15 cm, 6"
10 x 12 mm



Ragnell-Davis Retractor
08-127 8 x 4 mm
08-128 15 x 5.5 mm

RETRACTORS

Wundhaken | Ecarteurs
Separadores | Divaricatori



Fig.1
08-129
12 x 12 mm

Fig.2
08-130
12 x 14 mm

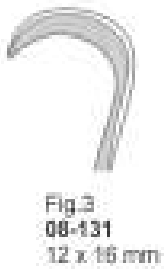


Fig.3
08-131
12 x 16 mm

Mannerfelt Hooklet Retractors
15.5cm



08-132
8 mm

08-133
10 mm

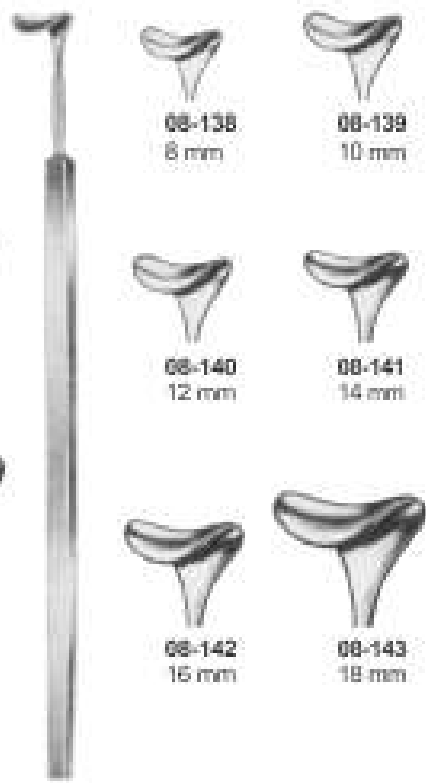
08-134
12 mm

08-135
14 mm

08-136
16 mm

08-137
18 mm

Cushing Hooklet Retractors
20cm



08-138
8 mm

08-139
10 mm

08-140
12 mm

08-141
14 mm

08-142
16 mm

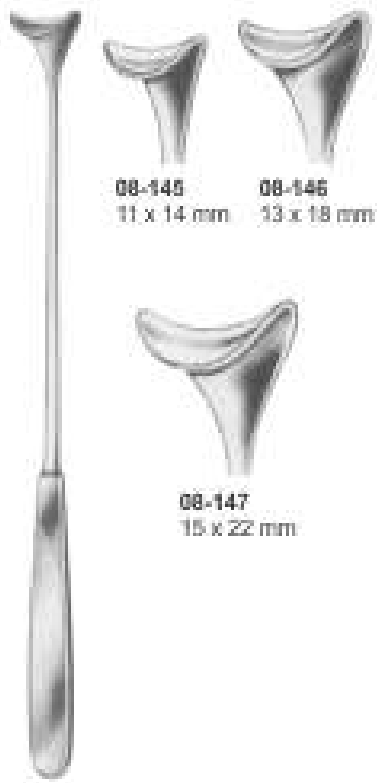
08-143
18 mm

Cushing Hooklet Retractors
24cm



08-144
10 x 10 mm

Cushing-Kocher Hooklet Retractors
18 cm.



08-145
11 x 14 mm

08-146
13 x 18 mm

08-147
15 x 22 mm

Cushing Hooklet Retractors
24cm



08-148
7 x 8 mm

08-149
9 x 10 mm

08-150
9 x 12 mm

08-151
11 x 14 mm

08-152
13 x 16 mm

08-153
13 x 18 mm

Desmarres Lid Retractors
16cm

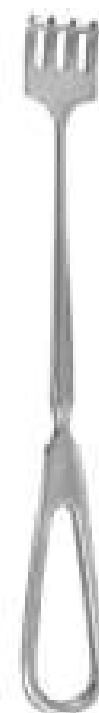
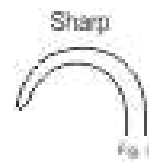
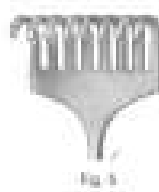


08-154 19 cm 19 x 12 mm
08-155 19 cm 21 x 15 mm
08-156 23 cm 35 x 18 mm
08-157 23 cm 50 x 20 mm
08-158 23 cm 60 x 25 mm
08-159 23 cm 75 x 30 mm
08-160 23 cm 75 x 40 mm

Kocher Retractor



Kocher Retractor
22 cm
08-161 40 x 10 mm
08-162 40 x 15 mm
08-163 40 x 20 mm



- 08-174 Blunt, 2 prongs.
- 08-175 Blunt, 3 prongs.
- 08-176 Blunt, 4 prongs.
- 08-177 Blunt, 5 prongs.
- 08-178 Blunt, 6 prongs.
- 08-179 Sharp, 2 prongs.
- 08-180 Sharp, 3 prongs.
- 08-181 Sharp, 4 prongs.
- 08-182 Sharp, 5 prongs.
- 08-183 Sharp, 6 prongs.

- Kocher Retractor**
- 08-164 22 cm, 8 1/4" 15 x 10 mm 2 prong Fig. 1
 - 08-165 22 cm, 8 1/4" 15 x 15 mm 3 prong Fig. 2
 - 08-166 22 cm, 8 1/4" 15 x 20 mm 4 prong Fig. 3
 - 08-167 22 cm, 8 1/4" 15 x 30 mm 6 prong Fig. 4
 - 08-168 22 cm, 8 1/4" 15 x 40 mm 8 prong Fig. 5

- Kocher Retractor**
- 08-169 22 cm, 8 1/4" 15 x 10 mm 2 prong Fig. 1
 - 08-170 22 cm, 8 1/4" 15 x 15 mm 3 prong Fig. 2
 - 08-171 22 cm, 8 1/4" 15 x 20 mm 4 prong Fig. 3
 - 08-172 22 cm, 8 1/4" 15 x 30 mm 6 prong Fig. 4
 - 08-173 22 cm, 8 1/4" 15 x 40 mm 8 prong Fig. 5

Volkmann Retractors
Long Pattern
22.2 cm, 8 1/4"



Koerte Retractor
08-195 28cm
25 x 40 mm
semi-sharp

- Kocher Retractor**
- 08-184 22 cm, 8 1/4" 15 x 10 mm 2 prong Fig. 1
 - 08-185 22 cm, 8 1/4" 15 x 15 mm 3 prong Fig. 2
 - 08-186 22 cm, 8 1/4" 15 x 20 mm 4 prong Fig. 3
 - 08-187 22 cm, 8 1/4" 15 x 30 mm 6 prong Fig. 4
 - 08-188 22 cm, 8 1/4" 15 x 40 mm 8 prong Fig. 5

- Kocher Retractor**
- 08-189 22 cm, 8 1/4" 15 x 10 mm 2 prong Fig. 1
 - 08-190 22 cm, 8 1/4" 15 x 15 mm 3 prong Fig. 2
 - 08-191 22 cm, 8 1/4" 15 x 20 mm 4 prong Fig. 3
 - 08-192 22 cm, 8 1/4" 15 x 30 mm 6 prong Fig. 4
 - 08-193 22 cm, 8 1/4" 15 x 40 mm 8 prong Fig. 5

Koerte-Wagner Retractor
08-194 28cm
Sharp

RETRACTORS

Wundhaken | Ecarteurs
 Separadores | Divaricatori



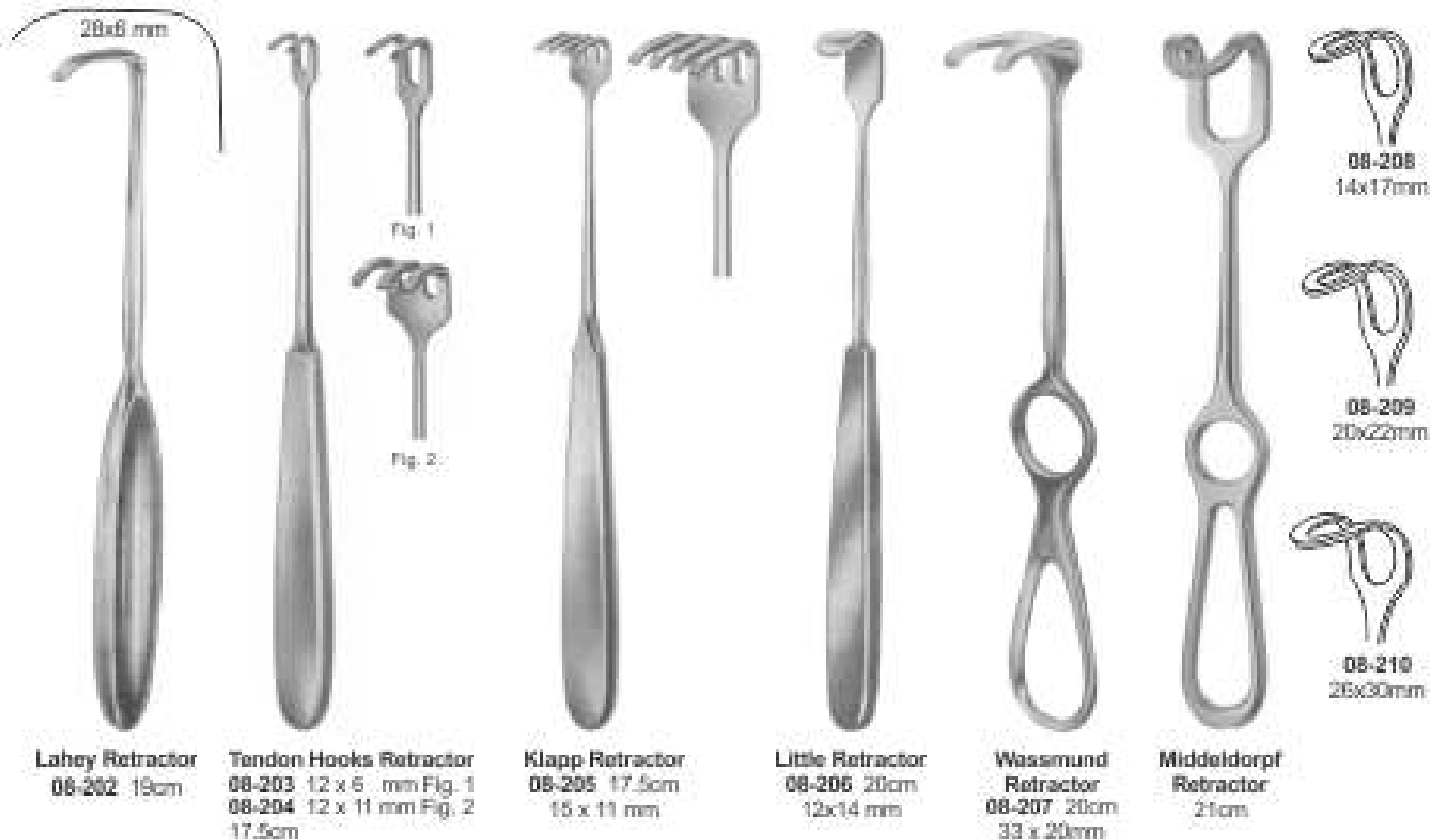
Koerte Retractor
 08-196 24 cm
 25 x 40 mm
 blunt

Koerte Retractor
 08-197 24cm
 26 x 40 mm
 sharp

Koerte I
 08-198
 Bl

Oiler Retractor
 08-200 18.5cm

Lahey Goller Retractor
 08-201 20.4cm
 Right angle blade, length
 1 inch. With lip.



Lahey Retractor
 08-202 19cm

Tendon Hooks Retractor
 08-203 12 x 6 mm Fig. 1
 08-204 12 x 11 mm Fig. 2
 17.5cm

Klapp Retractor
 08-205 17.5cm
 15 x 11 mm

Little Retractor
 08-206 20cm
 12x14 mm

Wassmund Retractor
 08-207 20cm
 33 x 20mm

Middeldorpf Retractor
 21cm

08-208
 14x17mm

08-209
 20x22mm

08-210
 26x30mm

RETRACTORS

Wundhaken | Ecarteurs
Separadores | Divaricatori



Kocher Retractor
28 cm, 11"



08-211



08-212



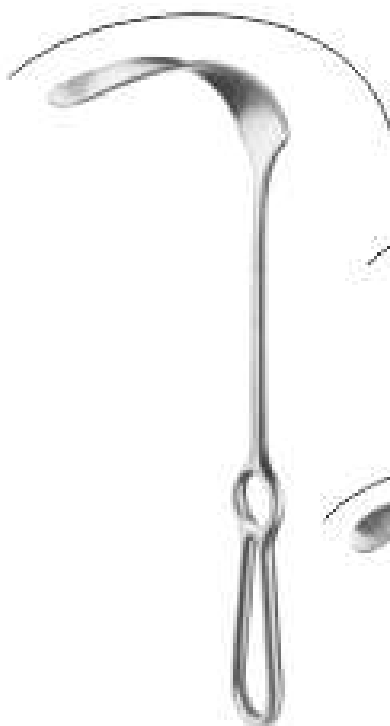
08-213



08-214



Kocher Retractor
08-215
22.5 cm 8 3/4"
70 x 25 mm



Kocher-Wagner Retractor
28 cm, 11"



08-216
22 x 15 mm



08-217
38 x 20 mm



08-218
67 x 25 mm



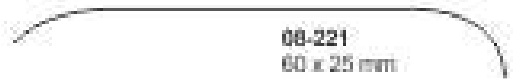
Kocher Retractor
23 cm, 9"



08-219
40 x 18 mm



08-220
60 x 20 mm



08-221
60 x 25 mm



08-222
75 x 30 mm



08-223
75 x 40 mm

RETRACTORS

Wundhaken | Ecarteurs
Separadores | Divaricatori



Kocher-Langenbeck Retractor
21.5 cm, 8 1/2"



08-224
25 x 6 mm



08-225
35 x 8 mm



08-226
35 x 11 mm



08-227
35 x 15 mm



08-228
40 x 11 mm



08-229
55 x 11 mm



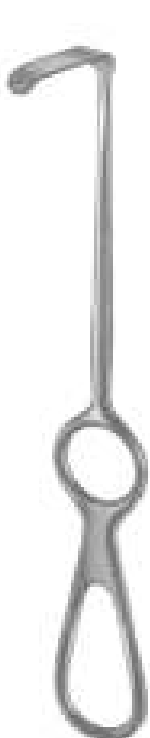
08-230
70 x 14 mm



08-231
80 x 12 mm



08-232
80 x 16 mm



Langenbeck Retractor
24 cm, 8 1/4"



08-233
35 x 7 mm



08-234
35 x 15 mm



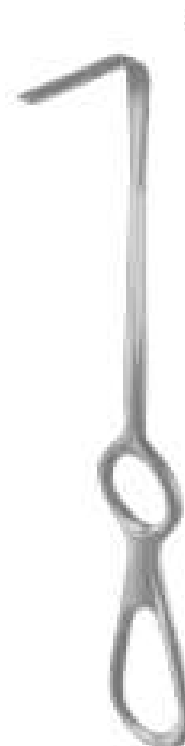
08-235
35 x 11 mm



08-236
35 x 20 mm



Langenbeck Retractor 08-237
21.5 cm 8 1/2"
Handle vertical to the blade



Langenbeck Retractor 08-238
21 cm 8 1/8"
38 x 9 mm



Casper Retractor
21 cm, 8 1/8"

RETRACTORS

Wundhaken | Ecarteurs
Separadores | Divaricatori



**Langenbeck
Retractor**
20.4 cm, 8"



08-241
20 x 7 mm



08-242
30 x 7 mm



08-243
30 x 11 mm



08-244
30 x 15 mm



08-245
30 x 20 mm



08-246
44 x 10 mm



08-247
44 x 15 mm



08-248
45 x 20 mm



08-249
50 x 20 mm



08-250
60 x 20 mm



**Meyering Finger
Retractor**
18 cm, 7"



08-251
long blunt blade,
6 x 17 mm



08-254
long toothed blade,
5 x 16mm



08-252
short toothed blade,
3 x 6 mm



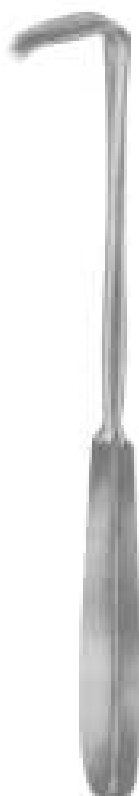
08-255
short blunt blade,
3 x 10mm



08-253
curved blunt blade,
3 x 8mm
Saddle-Shaped



08-256
curved three prong
sharp blade,
10 x 4mm



**Langenbeck
Retractor**
22 cm, 8 1/2"



08-257
25 x 6 mm



08-260
35 x 15 mm



08-264
25 x 6 mm



08-267
35 x 15 mm



08-258
35 x 8 mm



08-261
41 x 11 mm



08-265
35 x 8 mm



08-268
41 x 11 mm



08-259
35 x 11 mm



08-262
55 x 11 mm



08-266
35 x 11 mm



08-269
55 x 11 mm



08-263
70 x 14 mm



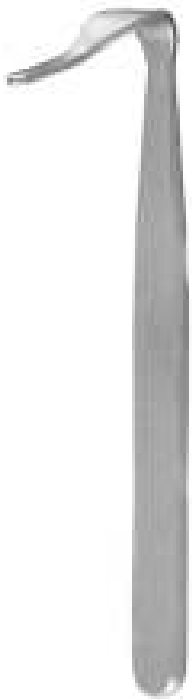
**Langenbeck
Retractor**
22 cm, 8 1/2"



08-270
70 x 14 mm

RETRACTORS

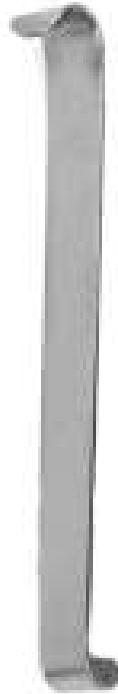
Wundhaken | Ecarteurs
Separadores | Divaricatori



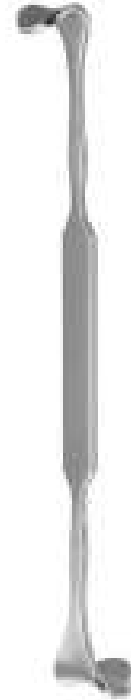
Blount Knee Retractor
08-271
17.5 cm, 6 1/2"
42 x 4 mm



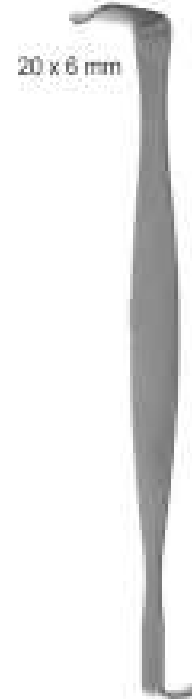
Taylor Spinal Retractors
08-272 16.5 cm, 6 1/2"
75 x 30 mm / 100 x 30 mm



Luer Retractor
08-273 11 cm, 4 1/2"
10 x 8 mm / 12 x 11 mm



Rose Retractor
08-274 13 cm, 5"
12 x 12 mm /
12 x 15 mm



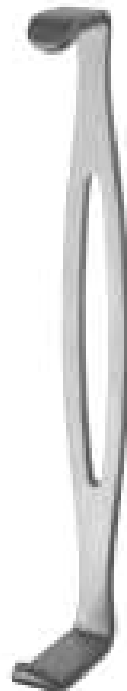
20 x 6 mm

12 x 4 mm

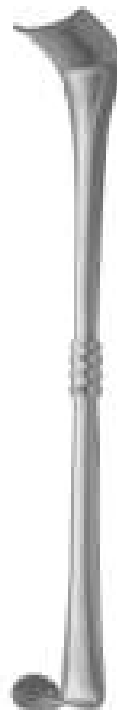
Crile Retractor
08-275 11 cm, 4 1/2"
12 x 4 mm /
20 x 6 mm



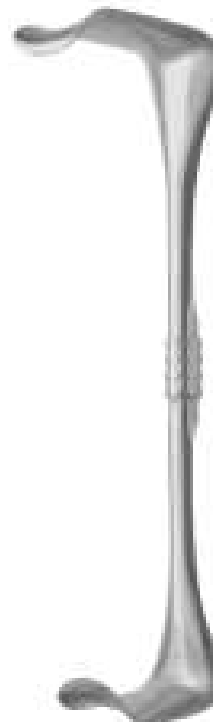
Mathieu Retractor
Set 2 pcs.
08-276 20 cm, 8"
47 x 13 / 46 x 26 mm
08-277 20 cm, 8"
42 x 13 / 42 x 26 mm



Us-Army Retractor
Set 2 pcs.
08-278 21.5 cm, 8 1/2"
28 x 15 / 42 x 15 mm
08-279 21.5 cm, 8 1/2"
25 x 15 / 38 x 15 mm



Richardson Eastman Retractor
08-280
26 cm, 10 1/4"
small



Richardson Eastman Retractor
08-281
28 cm, 11"



Sofield Retractor
08-282
set of 6 pcs.



Roux Retractor
Set 3 pcs. consisting of
08-283 14 cm, 5 1/2" 24 x 20 / 30 x 28 mm
08-284 15 cm, 6" 29 x 26 / 36 x 36 mm
08-285 17 cm, 6 1/2" 33 x 29 / 38 x 43 mm



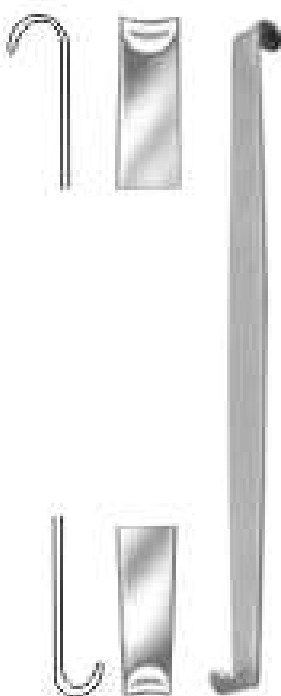
Baby-Roux Retractor
08-286 13 cm, 5" 15 x 15 mm / 18 x 21 mm



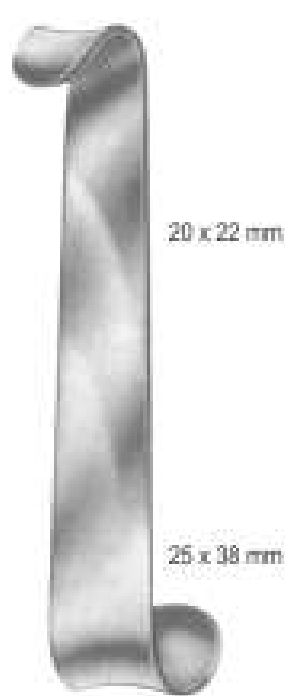
28 x 23 mm
43 x 23 mm
Roux Retractor
08-287 16.5 cm, 6 1/2" 28 x 23 mm / 43 x 23 mm



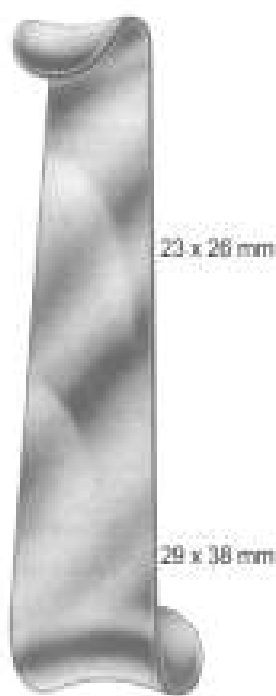
28 x 27 mm
45 x 27 mm
Roux Retractor
08-288 18.5 cm, 7 1/4" 28 x 27 mm / 45 x 27 mm



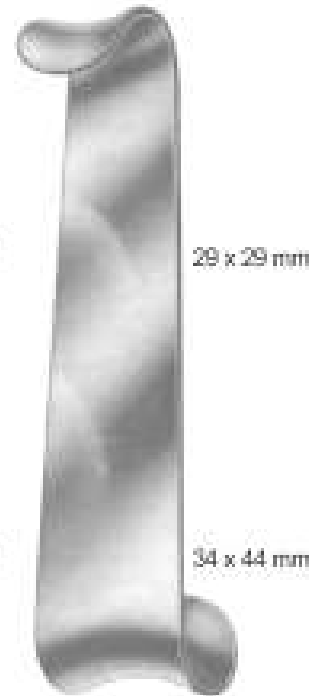
Mini-Roux Retractor
08-289 14 cm, 5 1/2"



20 x 22 mm
25 x 38 mm
Roux-Magnus Retractor
08-290 15 cm, 6" 20 x 22 mm / 25 x 38 mm



23 x 26 mm
29 x 38 mm
Roux-Magnus Retractor
08-291 16 cm, 6 1/4" 23 x 26 mm / 29 x 38 mm



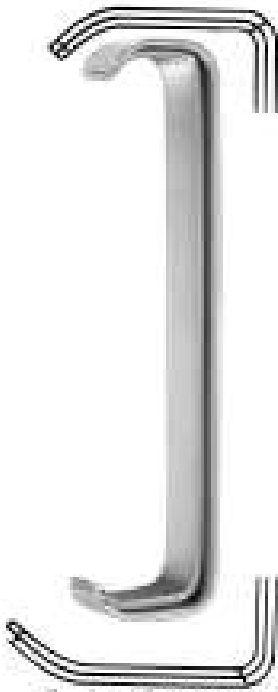
29 x 29 mm
34 x 44 mm
Roux-Magnus Retractor
08-292 17 cm, 6 3/4" 29 x 29 mm / 34 x 44 mm



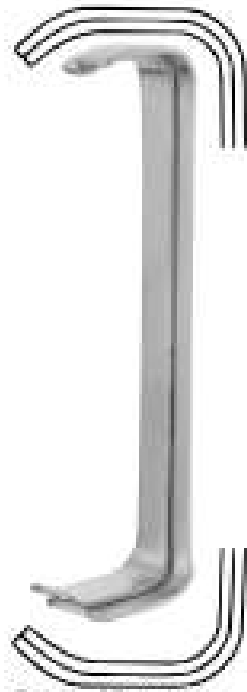
08-293
Baby (7x100mm)
08-294
Infant (10x120mm)
08-295
Adult (13x125mm)
08-296
Adult (15x150mm)
08-297
Extra Large (20x180mm)
Farabeuf Retractor

RETRACTORS

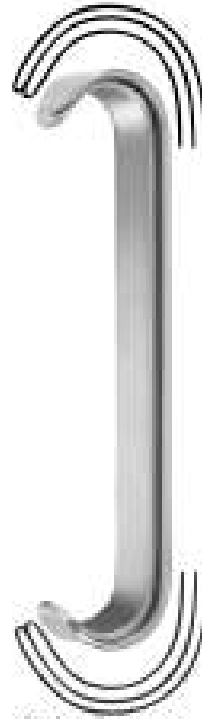
Wundhaken | Ecarteurs
Separadores | Divaricatori



Farabeuf Retractor
Set 2 Pcs.
08-298 13 cm, 5"
30 x 10 / 34 x 13 mm
08-299 13 cm, 5"
26 x 10 / 30 x 13 mm



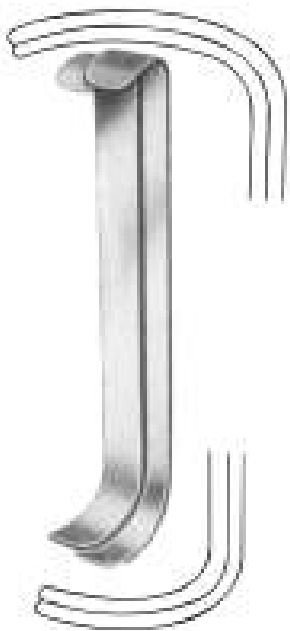
Farabeuf Retractor
Set 2 Pcs.
08-300 15 cm, 6"
27 x 16 / 30 x 16 mm
08-301 15 cm, 6"
23 x 16 / 26 x 16 mm



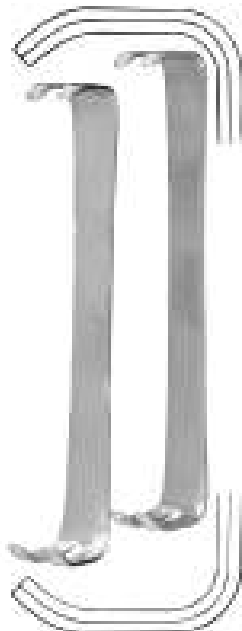
Parker Retractor
Set 2 pcs.
08-302 13.5 cm, 5 1/4"
22 x 15 mm / 22 x 15 mm
08-303
18.4 cm 7 1/4"



Parker Retractor
08-304 13.5 cm, 5 1/4"
18 x 15 mm / 19 x 15 mm



Collin Retractor
Set 2 pcs.
08-305 16.5 cm, 6 1/2"
25 x 12 / 35 x 16 mm
08-306 16.5 cm, 6 1/2"
28 x 12 / 30 x 16 mm



Mayo-Collin Retractor
Set 2 pcs.
08-307 15 cm, 6"
28 x 18 / 25 x 18 mm



Parker-Langenbeck Retractor
Set of 2 Pcs.
08-308 25 x 15 mm fig. 2
08-309 21 x 15 mm fig. 1
08-310 40 x 15 mm fig. 1
08-311 46 x 15 mm fig. 2



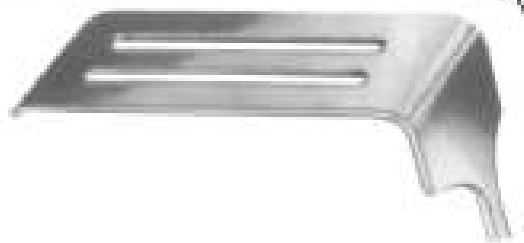
Parker-Mott Retractor
08-312
18 cm 6 1/4"
68 x 24 / 74 x 24 mm

08-313
115 x 65 mm



Coryllos Retractor
22.5 cm, 8 7/8"

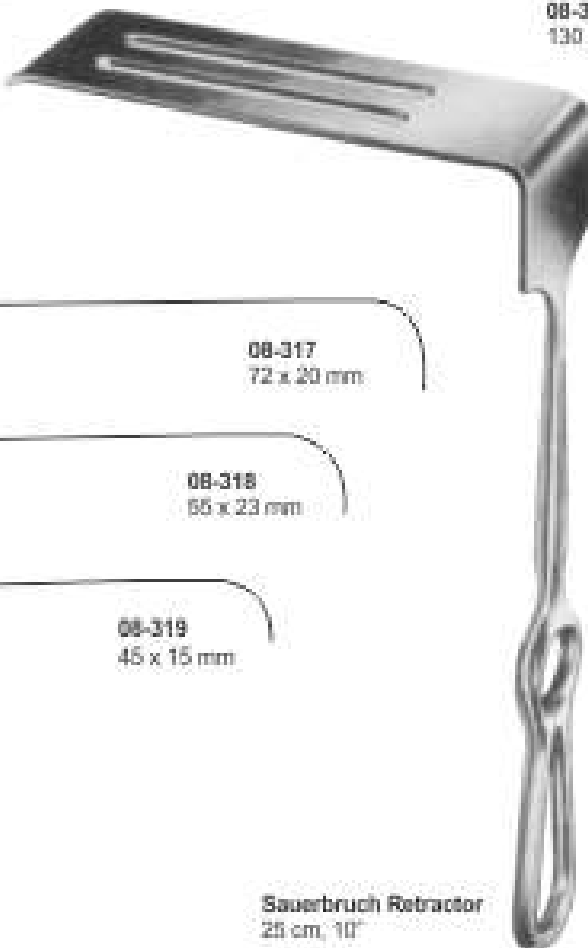
08-314
115 x 38 mm



08-315
82 x 22 mm



08-316
130 x 38 mm



08-317
72 x 20 mm



08-318
65 x 23 mm



08-319
45 x 15 mm



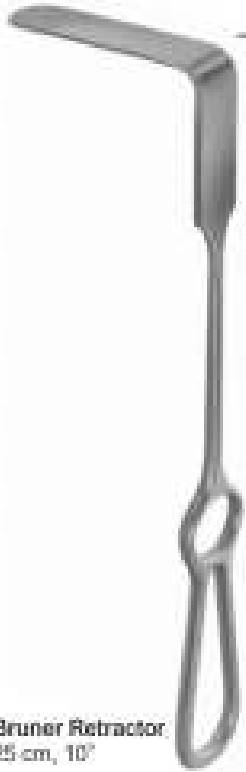
Sauerbruch Retractor
25 cm, 10"



Davidson Retractor
08-320 16 cm, 6 1/4" 75 x 50 mm
08-321 16 cm, 6 1/4" 75 x 90 mm

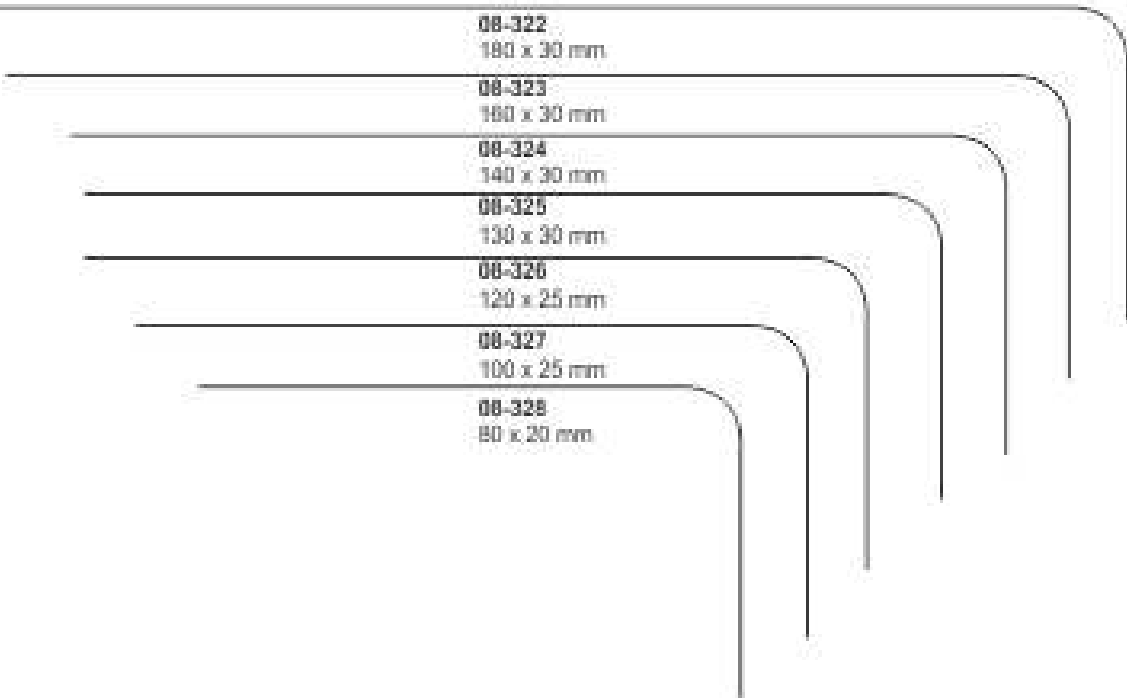
RETRACTORS

Wundhaken | Ecarteurs
 Separadores | Divaricatori



Bruner Retractor
 25 cm, 10"

- 08-322**
180 x 30 mm
- 08-323**
160 x 30 mm
- 08-324**
140 x 30 mm
- 08-325**
130 x 30 mm
- 08-326**
120 x 25 mm
- 08-327**
100 x 25 mm
- 08-328**
80 x 20 mm



- 190 x 30 mm
- 160 x 30 mm
- 140 x 25 mm
- 120 x 25 mm
- 100 x 20 mm
- 80 x 20 mm



Bruner Retractor
 24 cm, 9 1/2"

- 08-329** 80 x 20 mm
- 08-330** 100 x 20 mm
- 08-331** 120 x 25 mm
- 08-332** 140 x 25 mm
- 08-333** 160 x 30 mm
- 08-334** 180 x 30 mm



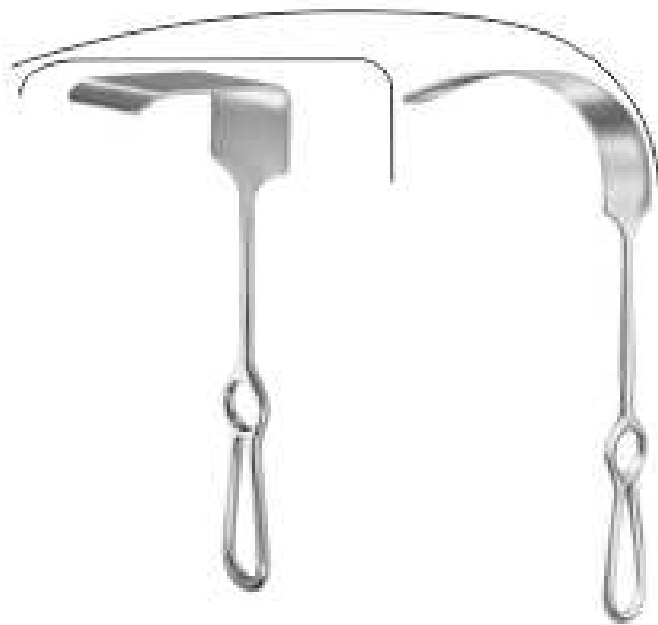
Bruner Retractor
 24 cm, 9 1/2"

- 08-335** 80 x 20 mm
- 08-336** 100 x 20 mm
- 08-337** 120 x 25 mm
- 08-338** 140 x 25 mm
- 08-339** 160 x 30 mm
- 08-340** 180 x 30 mm



RETRACTORS

Wundhaken | Ecarteurs
Separadores | Divaricatori



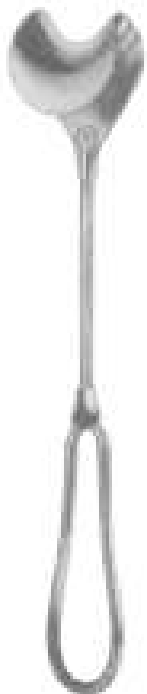
Mikulicz Retractor
26 cm, 10 1/2"
08-351
85 x 50 mm

Kelly Retractor
27 cm, 10 1/2"
08-352
190 x 38 mm
08-353
190 x 57 mm



Mikulicz Retractor
26 cm, 10 1/2"
08-354
95 x 35 mm

Mikulicz Retractor
26 cm, 10 1/2"
08-355
120 x 50 mm
08-356
150 x 50 mm



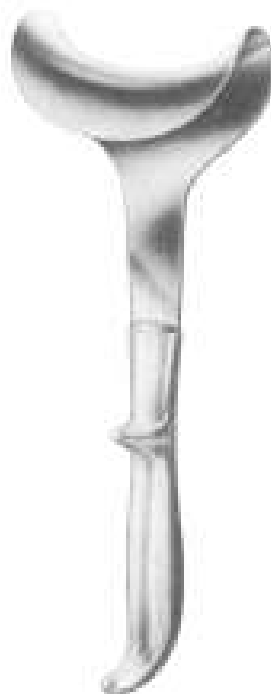
Cheek And Lip Retractor
19 cm, 7 1/2"
08-357
Movable



Tuffier Retractor
23 cm, 9"
08-358 55 x 63 mm



Bennet Retractor
08-359
24cm.



Doyen Retractor
26 cm, 10"
08-360 50 x 85 mm



Fritch Retractor
08-361
2.75 x 2 mm



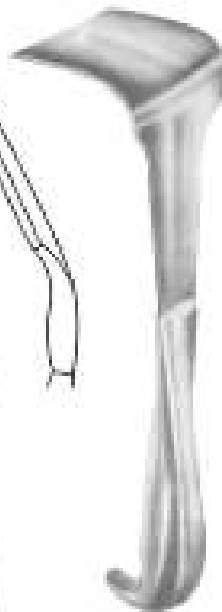
Fritch Retractor
24 cm, 9 1/2"
08-362 35 x 40 mm



Fritsch Retractor
08-363 24 cm, 9 1/2" 30 x 30 mm
08-364 24 cm, 9 1/2" 32 x 40 mm
08-365 24 cm, 9 1/2" 40 x 50 mm
08-366 24 cm, 9 1/2" 40 x 60 mm
08-367 24 cm, 9 1/2" 45 x 75 mm
08-368 24 cm, 9 1/2" 65 x 85 mm



Mikulicz Retractor
08-369
 29 cm 11.5"



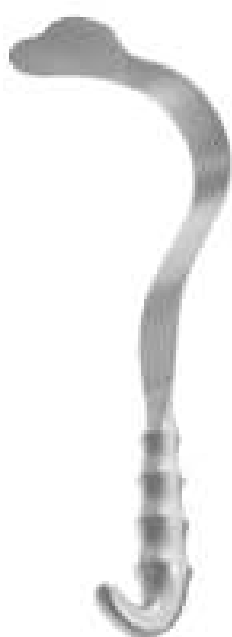
Tuffier Retractor
08-370 23 cm 9"
 64 x 60mm



Harrington Retractor
08-371 32 cm, 12 1/2"
 127 x 40 mm
08-372 127 x 62 mm



Harrington Extra Deep Retractor
08-373 30cm 11 3/4"
 Hollow handle, 5.7cm width x 20.5cm 8" depth blade



Harrington Splanchnic Retractor
08-374 31.5cm 12 1/2"
 Hollow handle, 3.8cm 1 1/2" width x 12.0cm 4 3/4" depth blade



Debaque-Cooly Retractor
08-375 31.0cm 12 1/4"
 Hollow handle, 5.7cm 2 1/4" width x 19.4cm 7 1/4" depth blade



Meyering Retractor
08-376
 22.5 cm, 9"
 75 x 25mm



08-377
 50 x 16mm



08-378
 75 x 15mm

Goelst Retractor
08-379
 19 cm 7 1/2"
 Double Ended

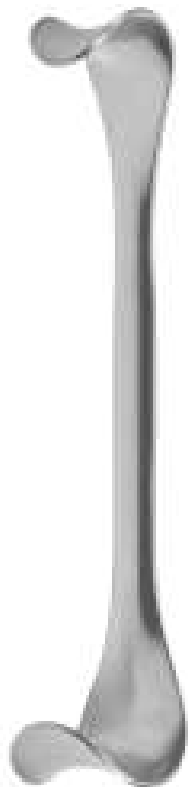
RETRACTORS, VEIN HOOKS

Wundhaken, Venenhäkchen

Ecarteurs, Ecarteurs sous

Separadores, Ganchitas Para venas

Divaricatori, Divaricatori per ueni



08-380



30 x 30 mm



40 x 40 mm



Kaye-Millard Retractor
08-381
8 cm, 3 1/4"



Richardson/Kelly Retractor
08-382
24 cm, 9 1/2"



08-382
5 x 31mm



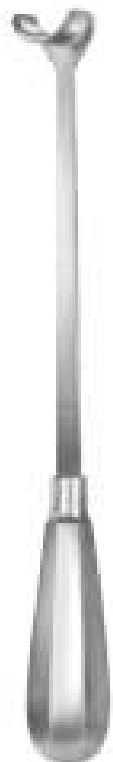
08-383
19 x 51mm



08-384
38 x 51mm



08-385
64 x 76mm



Ross Retractor
25.5 cm, 10"



08-386
Fig.01



08-387
Fig.02



08-388
Fig.03



08-389
Fig.04



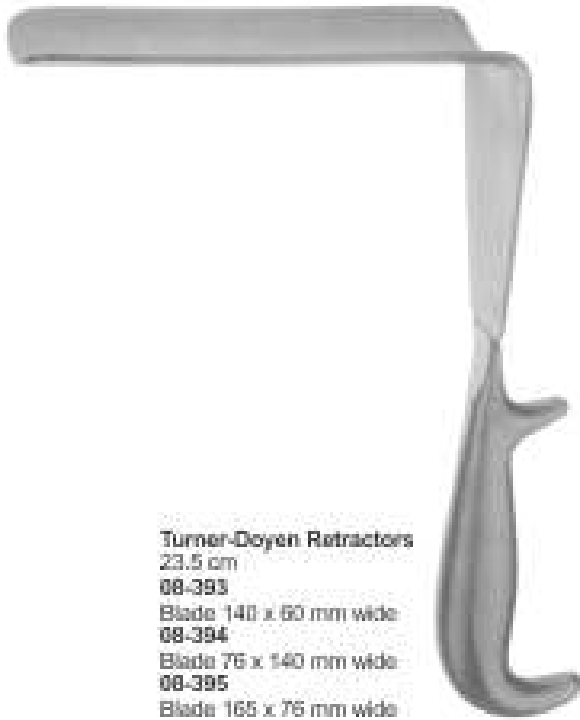
08-390
Fig.05



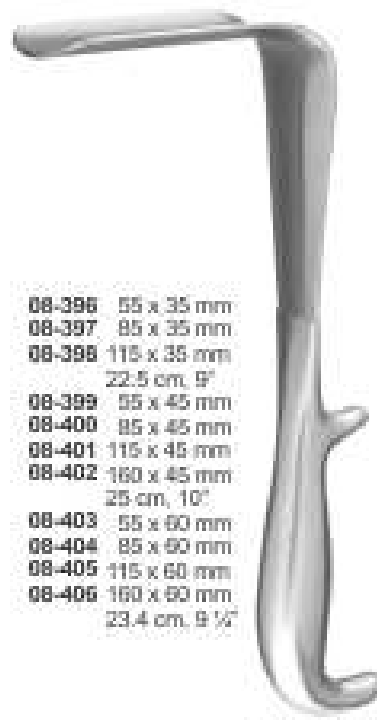
08-391
Fig.06



Weinberg Vagotomy Retractor (Joe's Hoe)
08-392 20 cm, 8"
Blade 102 x 165 mm wide



Turner-Doyen Retractors
23.5 cm
08-393
Blade 140 x 60 mm wide
08-394
Blade 76 x 140 mm wide
08-395
Blade 165 x 76 mm wide



08-396 55 x 35 mm
08-397 85 x 35 mm
08-398 115 x 35 mm
22.5 cm, 9"
08-399 55 x 45 mm
08-400 85 x 45 mm
08-401 115 x 45 mm
08-402 160 x 45 mm
25 cm, 10"
08-403 55 x 60 mm
08-404 85 x 60 mm
08-405 115 x 60 mm
08-406 160 x 60 mm
23.4 cm, 9 1/2"

Doyen Vaginal Retractors



08-407 23cm
Small Blade 70x19mm wide
08-408 25cm
Medium Blade 82x29mm wide
08-409 28cm
Large Blade 22x64mm
08-410 28cm
Large Blade 38x89mm

Sawyer Retractors



08-411 23cm
Blade 60x24mm wide
08-412 25cm
Blade 75x35mm wide

Ferguson-Moon Rectal Retractors



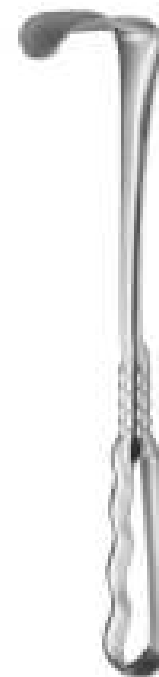
08-413 23cm
Blade 64x24mm wide
08-414 23cm
Blade 76x32mm wide
08-415 25cm
Blade 76x35mm wide

Hill Ferguson Rectal Retractors



08-416 24cm
50x40mm wide
08-417 24cm
65x50mm wide
08-418 25cm
75x55mm wide
08-419 25cm
90x75mm wide

Kelly Retractors



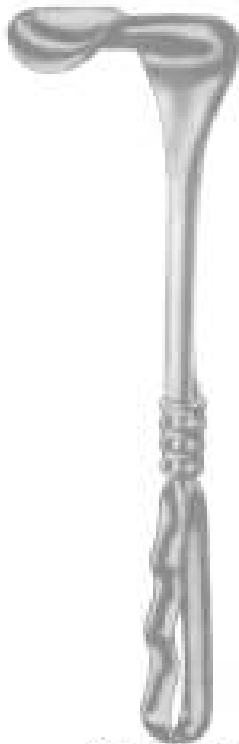
Richardson Retractors



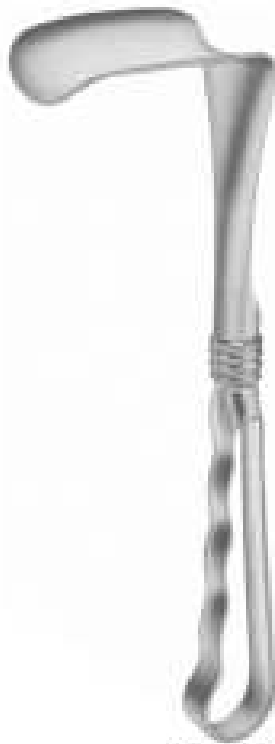
08-420 24cm
Blade 29x20mm wide
08-421 24cm
Blade 36x28mm wide
08-422 24cm
Blade 44x28mm wide
08-423 25cm
Blade 52x22mm wide
08-424 25cm
Blade 70x52mm wide

RETRACTORS

Wundhaken | Ecarteurs
 Separadores | Divaricatori



Kelly Retractor
 08-425 25cm
 55x50mm



Kelly Retractor
 26cm



08-426
 70 X 65 mm



08-427
 64 X 64 mm



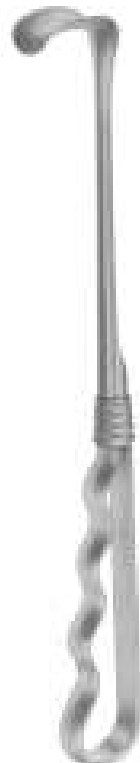
Morris Retractor
 24.5 cm 9 1/2"

08-428 70x40mm
 08-429 70x50mm
 08-430 70x65mm



Richardson Retractor
 08-431 24cm

47 x 21 mm



Richardson Retractor
 24.0 cm 9.5"



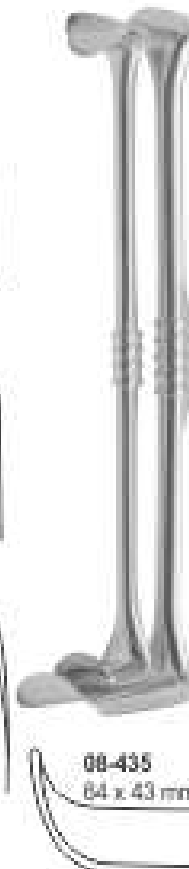
08-432
 21 x 20 mm



08-433
 30 x 29 mm



08-434
 37 x 37 mm

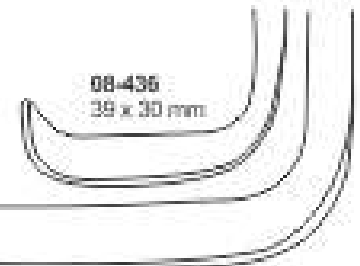


Richardson-Eastman Retractor
 26.0 cm 10", Set of 2 piece



38 x 37 mm

22 x 21 mm



08-436
 39 x 30 mm

08-435
 64 x 43 mm

RETRACTORS

Wundhaken | Ecarteurs
Separadores | Divaricatori



Malleable Retractor

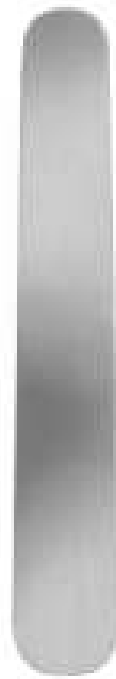
Item	Description	Tip
08-437	20 cm	12 mm
08-438	20 cm	17 mm
08-439	20 cm	25 mm
08-440	33 cm	25 mm
08-441	33 cm	32 mm
08-442	33 cm	40 mm
08-443	33 cm	50 mm



Ribbon Retractor
08-444
20 cm, 8"
Width 4 cm



Ribbon Retractor
08-445
20 cm, 8"
Width 2.5 cm



Tuffler / Haberer Retractor
08-446 20 cm, 8"
17 x 25 mm
08-447 28 cm,
11" 25 x 30 mm
08-448 30 cm,
11 1/2" 37 x 45 mm
malleable



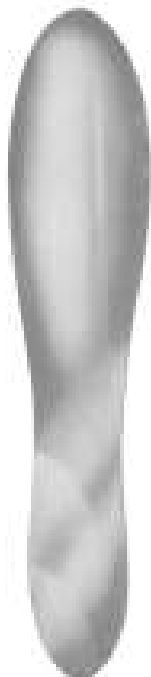
Bruening Spatula
08-449
19 cm



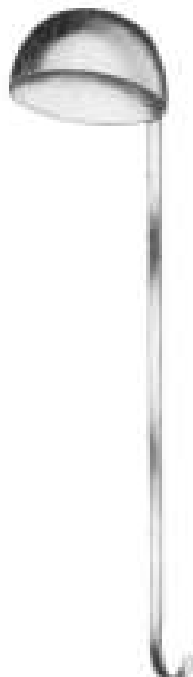
Flexival Abdominal Spatula
08-450 300x20mm
08-451 300x25mm
08-452 300x30mm
08-453 300x35mm
08-454 300x40mm
08-455 300x45mm
08-456 300x50mm



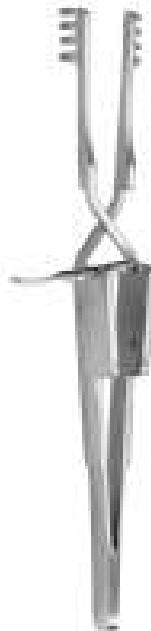
Reverdin Retractor
08-457
28cm
46x50mm



Reverdin Retractor
08-458
29cm



Blood Scoop
08-459
15cm



Heiss Retractor
08-460 10cm
Sharp 4:4
08-461 10cm
Blunt 4:4



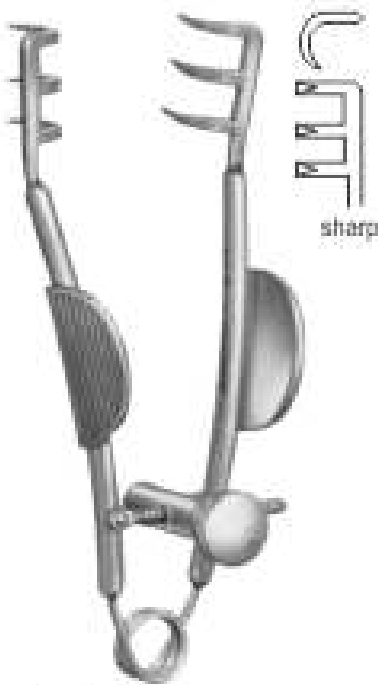
Finsen Retractor
08-462 7 cm, 2 3/4"
3 x 4 teeth, sharp
08-463 7 cm, 2 3/4"
3 x 4 teeth, Blunt



Finsen Retractor
08-464 5 cm, 2"
2 x 3-teeth sharp/blunt
08-465 7 cm, 2 3/4"
2 x 3-teeth sharp/blunt

RETRACTORS

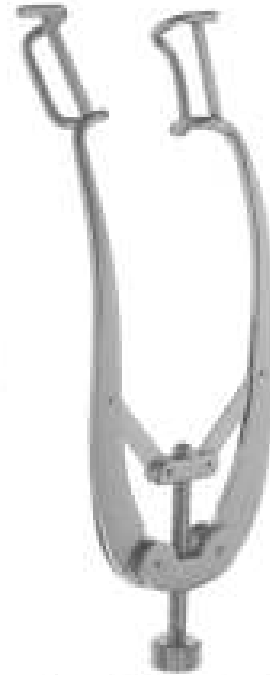
Wundhaken | Ecarteurs
Separadores | Divaricatori



Buckley Retractor
08-466 6cm



Lancaster Eye Speculum
08-467 8.3cm
blades 15 X 5 mm



Castrovisjo Eye Speculum
08-468 9.5cm
medium blades
15 X 5 mm O.D.



ALM Retractor
08-469 7 cm, 2 1/2"
4 x 4 teeth sharp/blunt
08-470 10 cm, 4"
4 x 4 teeth sharp/blunt



Wire Retaining Retractor
08-471 8.5 cm, 3 1/2" 3 x 3 Prong
08-472 8.5 cm, 3 1/2" 1 x 1 Prong Sharp



Farr Wire Retractor
08-473 14 cm 5 1/2"
prongs 1.9 cm 3/4"



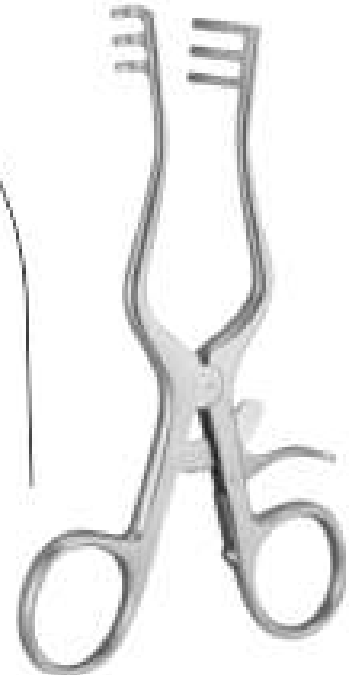
Jansen Retractor
08-474 10 cm, 4"
Sharp 3x3
08-475 10 cm, 4"
Blunt 3x3



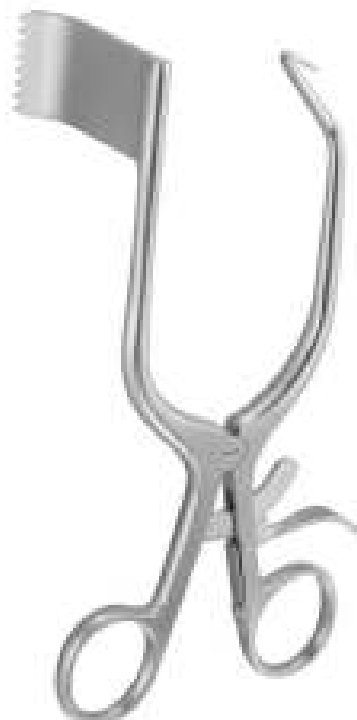
Houzel Retractor
08-476 29 cm, 11 W"



Mollison Retractor
08-477 15cm, 6"
sharp



Milligan Retractor
08-478 13 cm, 5"
18.5 mm x 20 mm
Blunt, 3x3



Markham/Meyering Retractor
08-479 18cm, Blade 55 x 25 mm Left
08-480 18cm, Blade 55 x 25 mm Right



Darling Retractor
08-481 18 cm, 7"
40 x 75/25 x 54 mm
08-482 18 cm, 7"
25 x 64/40 x 75 mm
Laminectomy Retractors
1 blade toothed



Debaque Gelpi Retractor
08-483 13.5cm 5 3/8"
Spread 3 1/8" 8cm, Sharp

RETRACTORS

Wundhaken | Ecarteurs
Separadores | Divaricatori



Gelpi-Lokite Retractor

- 08-484 9cm
- 5 mm Sharp
- 08-485 11cm
- 10 mm Sharp
- 08-486 14cm
- 10 mm Sharp
- 08-487 15cm
- 10 mm Sharp
- 08-488 19cm
- 10 mm Sharp



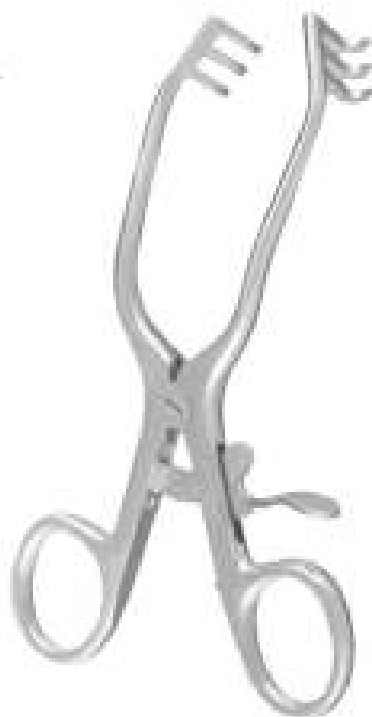
Gelpi-Perineal Retractor
08-489 17.8cm
ball stops on sharp tenaculum
prongs, arm length 12cm



Gelpi-Lokite Retractor
08-490 9 cm, 6mm Sharp Cross Over
08-491 11 cm, 10mm Sharp Cross Over
08-492 14 cm, 10mm Sharp Cross Over
08-493 16 cm, 10mm Sharp Cross Over
08-494 19 cm, 10mm Sharp Cross Over



Seletz-Gelpi Retractor
08-495 17.8cm, 7"
modified with long
curve in shanks



Schuhknecht Retractor
08-496 Sharp
08-497 Blunt
14 cm, 5 1/2"



Wulstein Retractor
08-498 08-501 10.5 cm, 4"
08-499 08-502 13.0 cm, 5"
08-500 08-503 16.0 cm, 6 1/4"
Sharp Blunt



Travers Retractor
08-504
21 cm, 8 1/4" Blunt

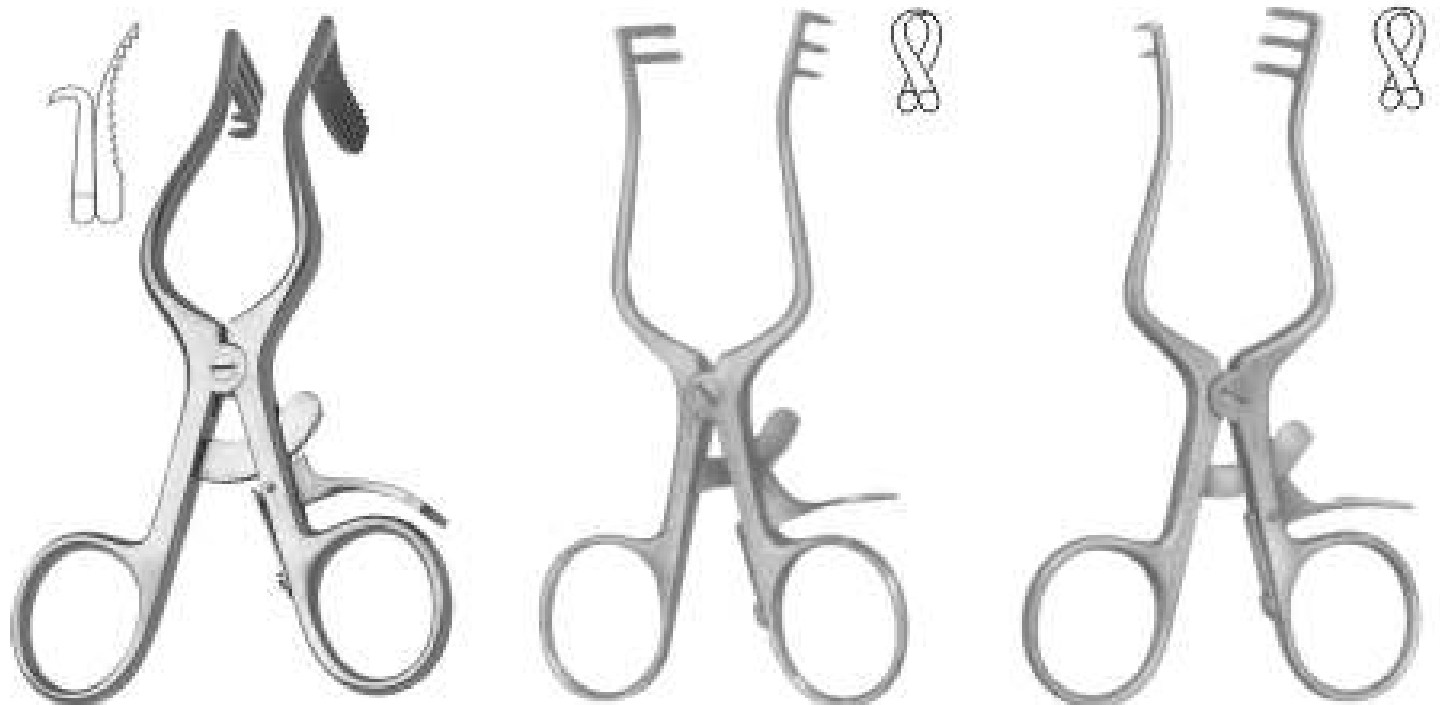


Righby Retractor
08-505 35 x 20 mm
08-506 60 x 20 mm
08-507 65 x 15 mm
18 cm, 7"

Weitlaner Retractor
08-508
13.0 cm 5.25"
Sharp

Weitlaner Retractor
08-509
16.5 cm 6.5"
Sharp

Plester Retractor
08-510
11.0 cm 4.25"
Blunt



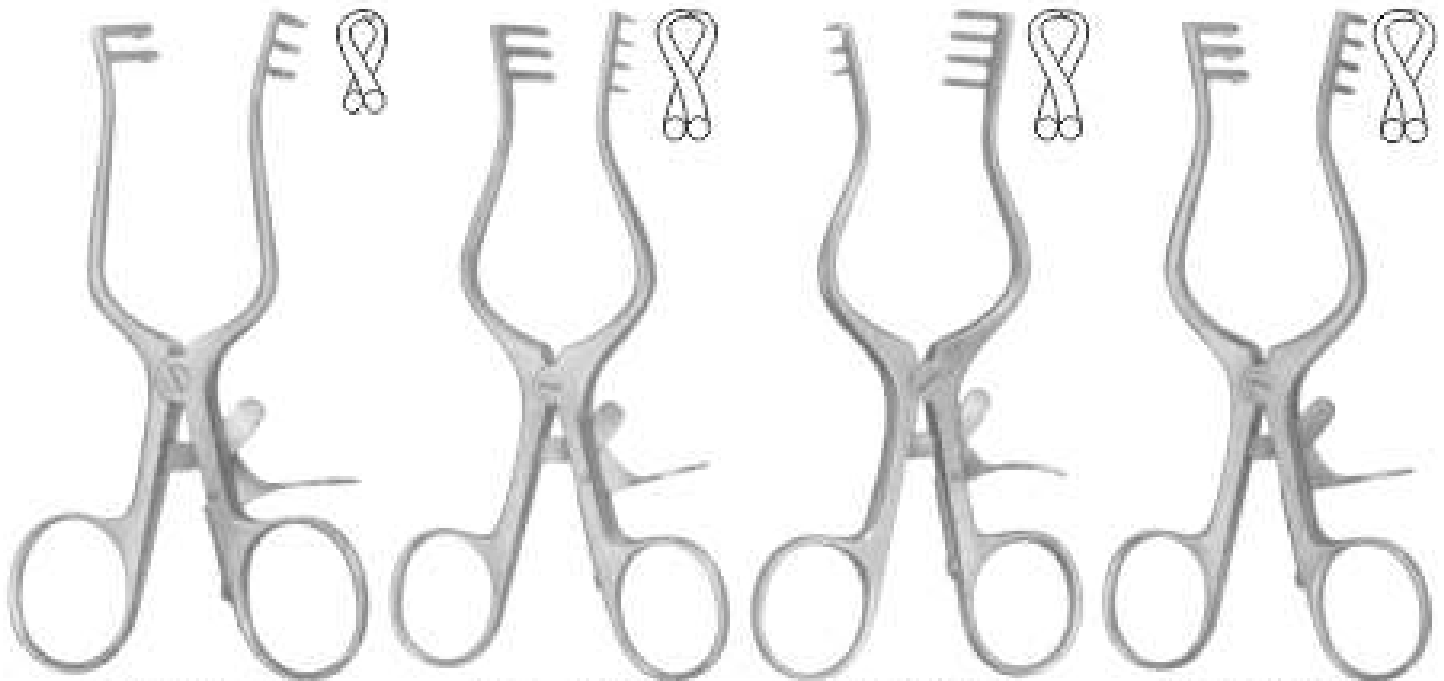
Perkins Retractor
08-511 13cm

Weitlaner Retractor
08-512 11 cm
Sharp

Weitlaner Retractor
08-513 11 cm
Semi-Sharp

RETRACTORS

Wundhaken | Ecarteurs
Separadores | Divaricatori



Weitlaner Retractor
08-514 11cm
Blunt

Weitlaner Retractor
08-515 13cm
Sharp

Weitlaner Retractor
08-516 13cm
Semi-Sharp

Weitlaner Retractor
08-517 13cm
Blunt



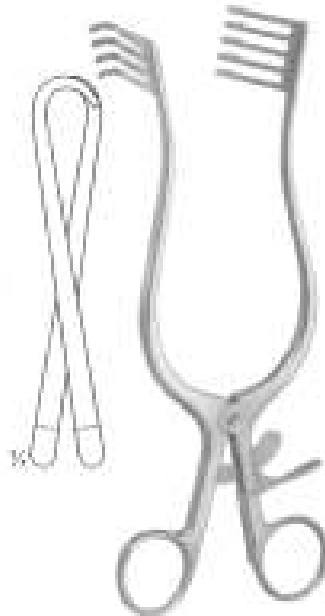
Kolbel Soft Tissue Retractor
08-518 18.0cm 7"
Angled, 2 x 2 Pronged

Meyering Retractor
08-519 16.5cm 6 1/2"
08-520 24.1cm 9 1/2" Large Blade
8.9 cm 3 1/2" X 5.1 cm 2"
08-521 24.1 cm 9 1/2" Small Blade
5.1 cm 2" X 1.5 cm 5/8"

D'Errico-Adson Retractor
08-522 19.0cm 7 3/8"
4 X 4-pronged,
2.0cm 3/4" depth blade
Sharp



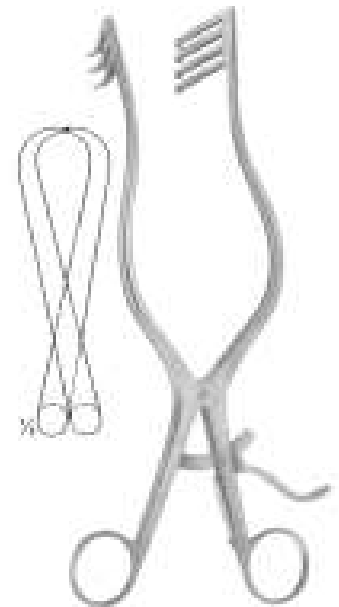
Anderson-Adson Retractor
08-523 19.0 cm 7 1/2"
Sharp



Norfolk & Norwich Retractor
08-524 22.0 cm 8 3/4"
Blunt



Adson Retractor
08-525
19.1 cm 7-1/2" sharp,
4 X 4 teeth straight Arms



Adson Retractor
08-526 28.5 cm 10 1/2"
Sharp



Beckman-Weitlaner Retractor
08-527 16.5cm 6 1/2"
3 x 4 Sharp prongs



Beckman-Weitlaner Retractor
08-528 16.5cm 6 1/2"
3 x 4 Blunt prongs

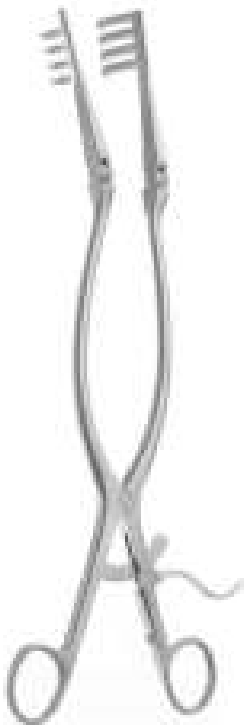


Cone Retractor

08-529 31 cm, 12"
3x4 Blunt prongs,
13 mm x 14.5 mm
08-530 16.5 cm, 6 1/2"
17 mm x 19 mm
3x4 Sharp prongs,
08-531 16.5 cm, 6 1/2"
17 mm x 19 mm
3x4 Blunt prongs,
08-532 20 cm, 8"
21 mm x 210 mm
3x4 Blunt prongs,

RETRACTORS

Wundhaken | Ecarteurs
 Separadores | Divaricatori



Beckman Retractor
 08-533 31.7cm 12 1/2"
 Spread 3.5cm 5 3/8" 4 x 4
 Sharp prongs; Arm length
 8.5cm 3 3/8"



Beckman Retractor
 08-534 31.1cm 12 1/4"
 4 x 4 Sharp prongs 27mm.
 Side Blade 1.7cm 5/8" deep.



Beckman Retractor
 08-535 31.1cm 12 1/4"
 4 x 4 Blunt prongs 27mm.
 Side Blade 1.7cm 5/8" deep.



Joll (Friedman)
 08-536 15.5 cm, 6 1/2"
 Thyroid- and Vaginal Retractor



Jackson Burrows Retractor
 08-537 18.5cm
 Blunt



Geipi Vaginal Retractor
 08-538 13.5cm



Geipi Skin & Vaginal Retractor
 08-539 17.5cm



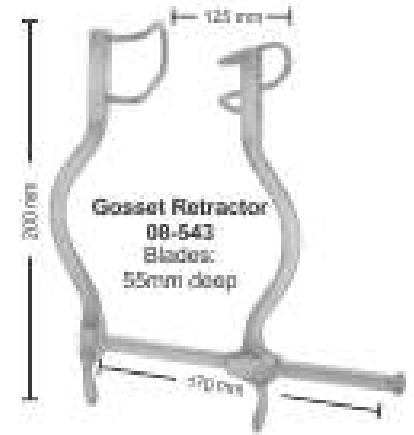
De Bakay Femur Retractor
 08-540 14.5cm



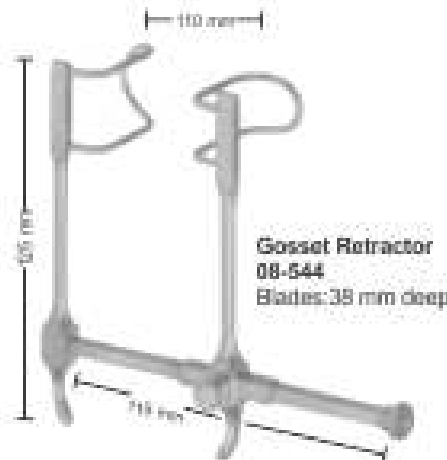
**Gosset Retractor
08-541**
Center Blades
40 x 30 mm



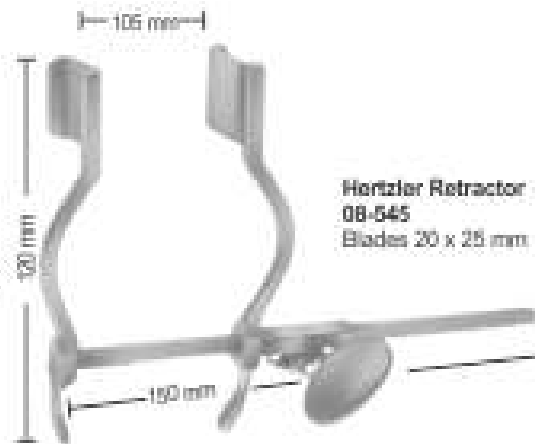
**Gosset Retractor
08-542**
Lateral Blades
58 mm deep
Center blade
59 x 57 mm



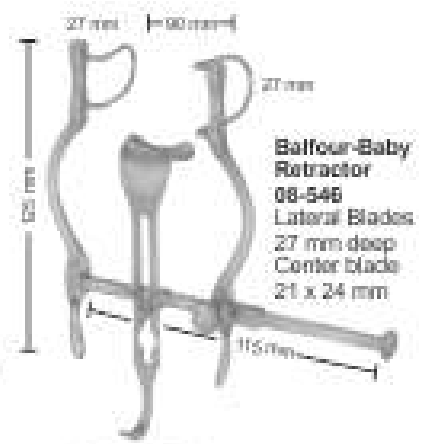
**Gosset Retractor
08-543**
Blades:
55mm deep



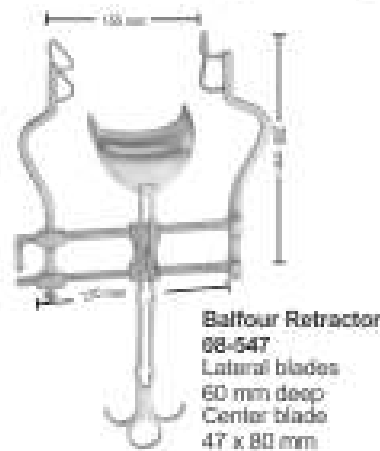
**Gosset Retractor
08-544**
Blades: 38 mm deep



**Hertzler Retractor
08-545**
Blades 20 x 25 mm



**Balfour-Baby
Retractor
08-546**
Lateral Blades
27 mm deep
Center blade
21 x 24 mm



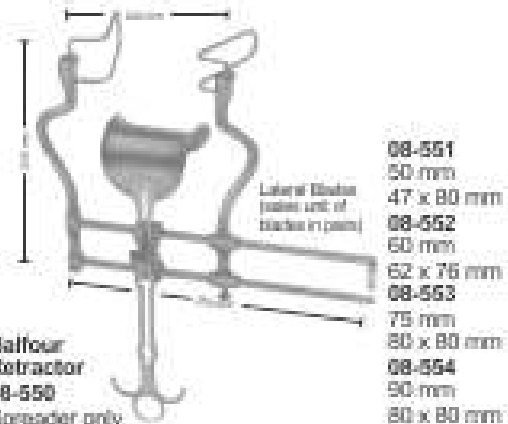
**Balfour Retractor
08-547**
Lateral blades
60 mm deep
Center blade
47 x 80 mm



**Balfour Retractor
08-548**
Lateral blades:
105 mm deep
Center blade
107 x 59 mm



08-549
Center blade only
54 x 80 mm

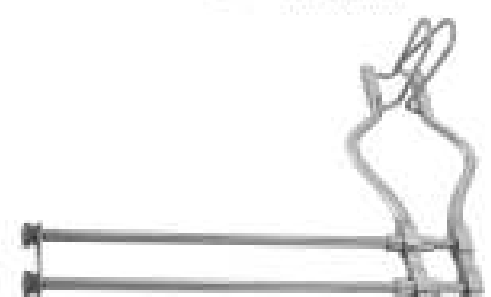


**Balfour
Retractor
08-550**
Spreader only

- 08-551 50 mm
- 08-552 47 x 80 mm
- 08-553 60 mm
- 08-554 62 x 76 mm
- 08-555 75 mm
- 08-556 80 x 80 mm
- 08-557 90 mm
- 08-558 80 x 80 mm



Finochietto Retractors
08-555 18x22 8cm
08-556 25x40 13cm
08-557 32x45 16cm
08-558 40x45 18cm



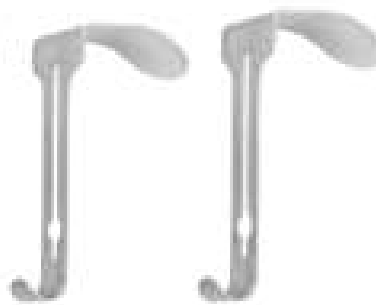
Gosset Abdominal Retractors
08-559 12cm
08-560 16cm
08-561 24cm
08-562 30cm

RETRACTORS

Wundhaken | Ecarteurs
Separadores | Divaricatori



08-565
Single Retractor Blade
110 x 70 mm



08-566
Set of 2 Retractor Blade
80 x 45 mm



**ABRE BOCA MC IVOR C/3
LAMINAS S/ SUCCAO
ABRE BOCA
08-567**

O'Sullivan/O'Connor Retractor
08-563 (Set includes frame & 3 blades)
08-564 Frame Only (not pictured)



08-568
Center Blade
45 x 80 mm
70 x 85 mm

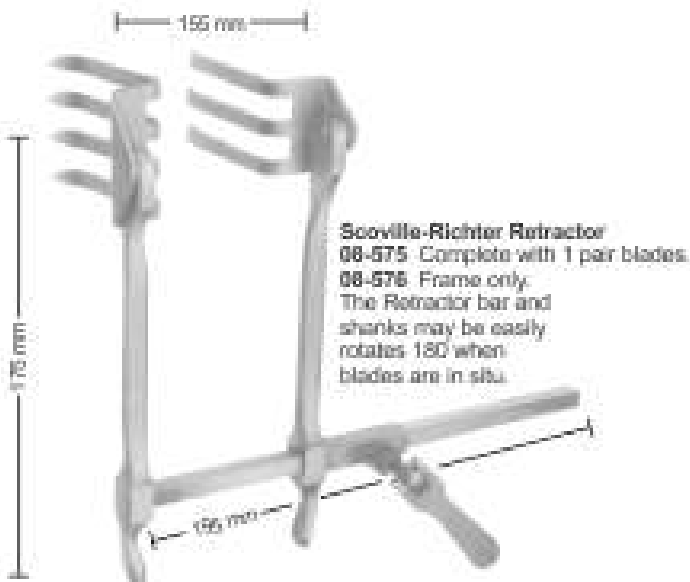


08-569
Center Blade
100 x 60 mm

Sizes of These Blades to
Same as about Blades.



Collin Retractor
08-570 Complete
08-571 Spreader only
08-572 Blades 55 x 25 mm
08-573 Blades 80 x 25 mm
08-574 Center Blade
115 x 45 mm



Scoville-Richter Retractor
08-575 Complete with 1 pair blades.
08-576 Frame only.
The Retractor bar and
shanks may be easily
rotates 180° when
blades are in situ.



08-577
62 x 52 mm

08-578
62 x 37 mm

08-579
47 x 51 mm



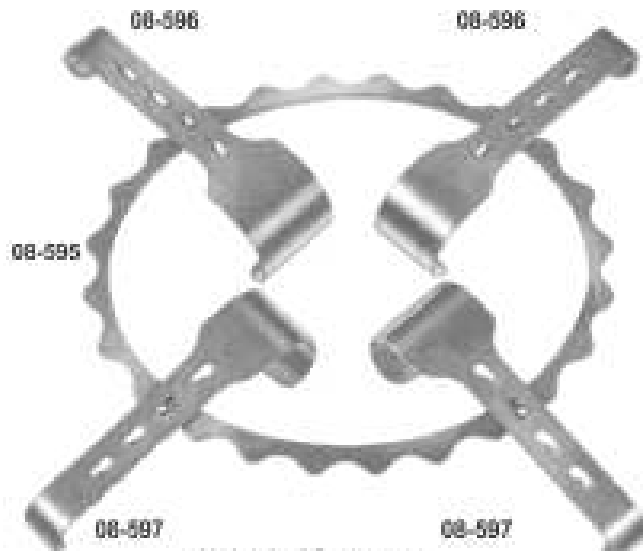
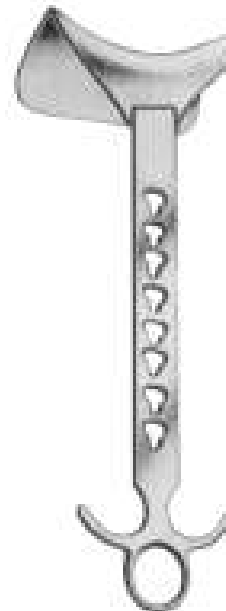
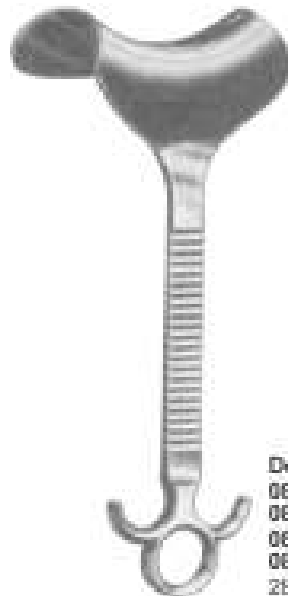
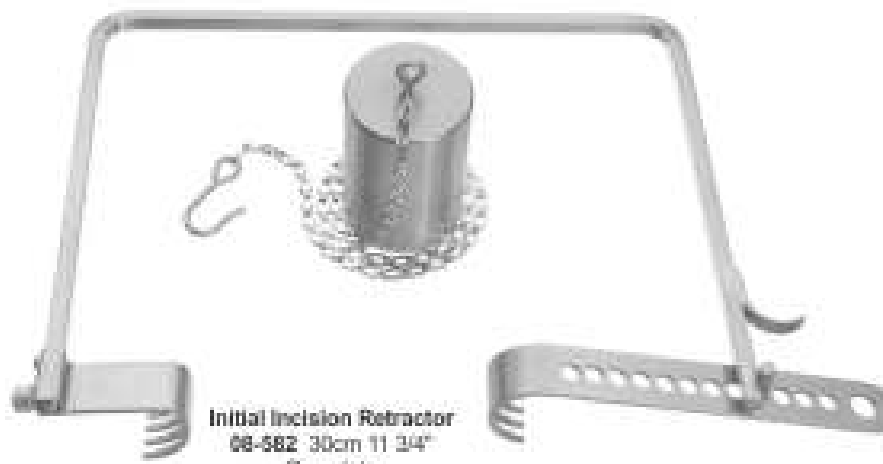
08-580
30 x 40 mm



08-581
37 x 62 mm

RETRACTORS

Wundhaken | Ecarteurs
Separadores | Divaricatori



Abdominal Retractors
for new-born and children

Denis-Browne Retractor
08-594 Complete with 4 blades

08-595 Frame 160 x 160 mm
08-596 2 blades only 40 x 30 mm
08-597 2 blades only 40 x 40 mm

08-598
Blades only 20 x 30 mm

08-599
Blades only 20 x 40 mm



RETRACTORS

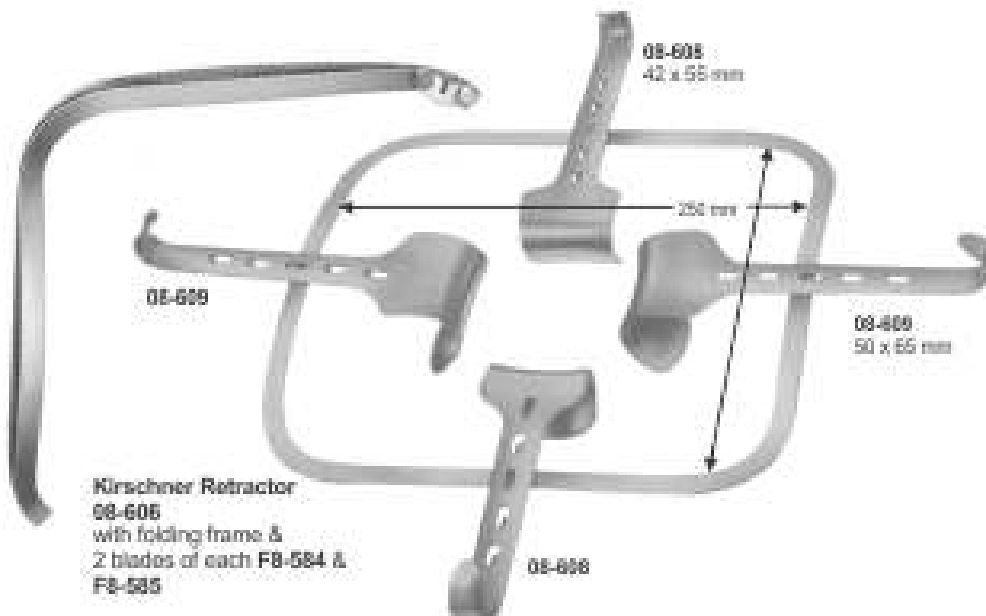
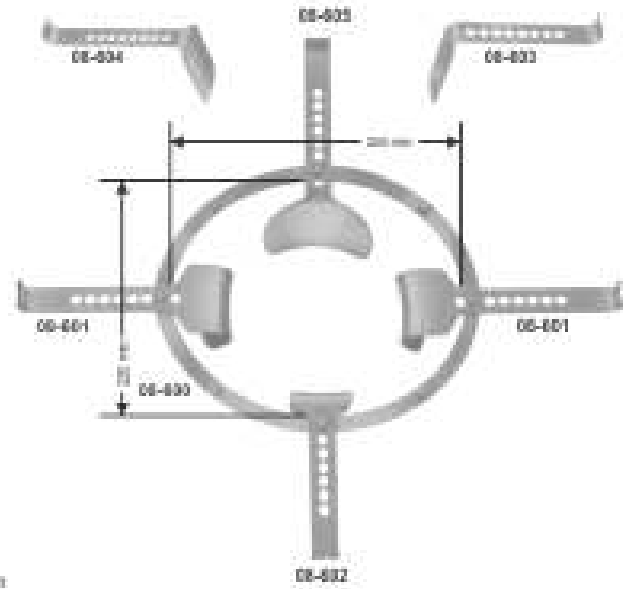
Wundhaken | Ecarteurs
Separadores | Divaricatori



Abdominal Retractors
well suitable for gynaecologists

Siemn Abdominal Retractors
consisting of:

- 08-600 1 frame 225 x 220 mm
- 08-601 2 blade 46 x 64 mm
- 08-602 1 blade 53 x 54 mm
(for bladder)
- 08-603 1 blade 82 x 97 mm
(for intestine)
- 08-604 1 blade 98 x 51 mm
(for intestine)
- 08-605 1 blade, narrow
107 x 36 mm



Kirschner Retractor 08-606
with folding frame &
2 blades of each 08-608 &
08-605

Kirschner Retractor 08-607
with vaulted fixed frame &
2 blades of each 08-608 &
08-605

08-610
300 x 380 mm
Frame only, over-sized

08-611
320 x 300 mm
Frame only

Additional valves for corpulent persons



Kirschner Retractor 08-612
64 x 80 mm



Kirschner-Balfour Retractor 08-613
80 x 82 mm



Kirschner Retractor 08-614 90 x 69 mm
08-615 92 x 95 mm
08-616 75 x 58 mm



Kirschner Retractor 08-617 108 x 42 mm
08-618 91 x 55 mm
08-619 121 x 55 mm



09-001
Grossmann Areola Marker,
40mm, 44mm, 48mm, 52mm



Freeman Areola Marker,
2 Sizes,
09-002 34mm / 36mm
09-003 38mm / 42mm
09-004 42mm / 45mm
09-005 45mm / 50mm



Freeman Areola Marker,
09-006 34mm
09-007 36mm
09-008 38mm
09-009 42mm
09-010 45mm
09-011 50mm



Freeman Areola Marker,
09-012 38 mm
09-013 42 mm
09-014 50 mm
09-015 45 mm
09-016 34 mm
09-017 36 mm



Solz Areola Marker, Blunt,
09-018 35mm Diameter
09-019 40mm Diameter
09-020 42mm Diameter
09-021 45mm Diameter



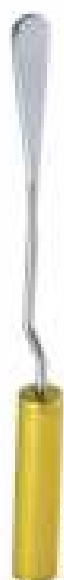
Solz Atraumatic
Breast Dissector,
09-022 34cm
09-023 37cm



Solz Breast Hook
Dissector,
09-024 36cm



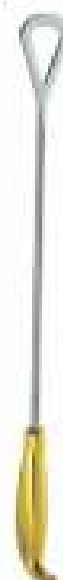
Agris Dingman Breast
Dissector, Set of 2,
Left And Right,
09-025 35cm



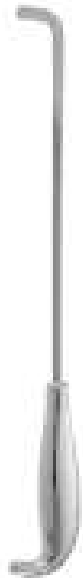
Maccollum Dingman
Submammary
Dissector,
09-026 30cm



Maccollum Dingman
Breast Dissector,
09-027 31.5cm
09-028 41cm



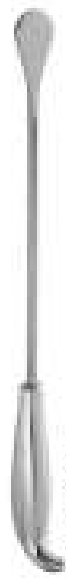
Reynolds Transauxiliary
Breast
Dissector, Fenestrated,
09-029 33cm
09-030 40cm



Breast Dissector,
Angulated Blade,
09-031 33cm
09-032 42cm



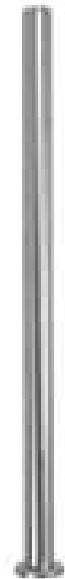
Breast Dissector,
Spatulated Blade,
09-033 33cm
09-034 42cm



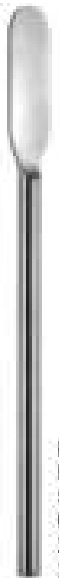
Breast Dissector,
Oval-Spatulated
Blade,
09-035 33cm
09-036 42cm



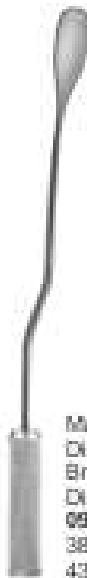
Spatula Breast
Retractor
Dissector,
Serrated,
09-037 1/2",
Semi Malleable



Trocar Breast Tube,
09-038 356mm
Total Length,
Large, 17.3mm Id,
19mm Od
09-038 343mm
Small, 14mm Id, 16mm Od



Pann Breast
Dissector,
Straight,
09-039
25mm Width
324mm Length



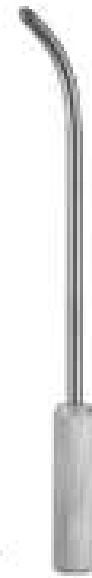
Maccollum,
Dingman
Breast
Dissector
09-040
38mm Width,
432mm Length



Moinis
Polycurette
Breast
Instrument
09-041
30mm Width
09-042
318mm Length



Iconoclast,
09-043 Large
292mm Length
146mm Blade
09-044 Small
222mm Length,
83mm Blade



Silverstein Breast
Dissector,
09-045
356mm Length



Breast Elevator For
Mammary Plasty
09-046



Temporal T
Dissector
09-047
23.5cm,
12mm Tip,
Straight



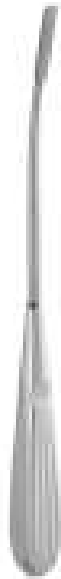
Flap Dissector
09-048 23.5cm
5mm Tip, Straight



Midface Facial
Dissector
09-049 24cm
Multiple Curves,
12mm Wide Tip



Transoral
Dissector
09-050
23.5cm
Curved Tip



Frontotemporal Dissector
09-051 22.5cm
 5mm Tip, Slightly Curved
09-052 23cm
 7mm Tip, Slightly Curved
09-053 23cm
 10mm Tip, Slightly Curved



Scalp Elevator 24cm
09-054 12.5mm Tip, Slightly Curved
09-055 15mm Tip, Slightly Curved
09-056 7mm Tip, Straight
09-057 12.5mm Tip, S Shaped
09-058 12.5mm Tip, Slightly Curved
09-059 7mm Tip, Curved Tip
09-060 7mm Tip, Strongly Curved
09-061 7mm Tip, Slightly Curved



Orbital Rim Dissector
09-062 22.5cm
 Slightly Curved



Frontoglabella Dissector
09-063 26.5cm
 7mm Tip, S Shaped



Arcus Marginalis Dissector
09-064 24cm
 10mm Tip, S Shaped



Periosteal Elevator
09-065 25cm
 S Shaped



Periosteal Spreader
09-066 24cm
 8mm Tip, S Shaped



Periosteal Spreader
09-067 24cm
 10mm Wide Blade, S Shaped



Zygomatic Arch Elevator
09-068 20.5cm
 Straight Blade, 5mm



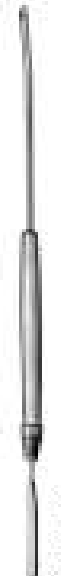
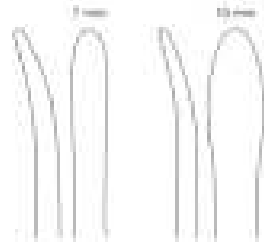
Scalp Elevator With Suction
09-069 24cm
 7mm Wide Tip, Slightly Curved



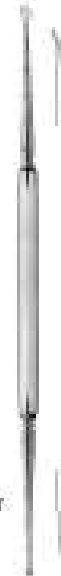
Scalp Elevator With Suction
09-070 25cm
 8.5mm Wide Tip, Curved Tip



Langenbeck Bone Elevator
09-071 20cm, 7mm, Blunt
09-072 20cm, 10mm, Blunt



Suction Elevator With Guide
09-073 21cm,
 4mm

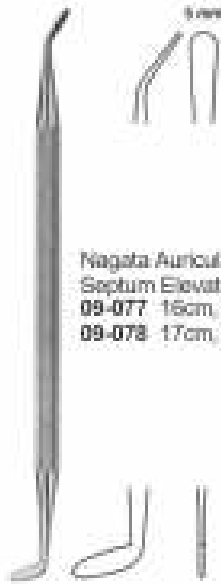


Cottle Periosteal Elevator
09-074 20cm,
 214mm, Double Ended, Fine
09-075 23cm,
 314mm, Double Ended





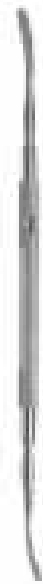
Masing Septum Elevator,
09-076 22cm
5mm, Double Ended



Nagata Auricular Septum Elevator,
09-077 16cm, Blunt
09-078 17cm, Blunt



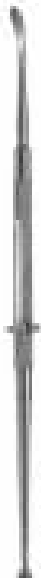
Halle Septum Elevator,
Narrow, 3 mm
Width
09-079 178mm
Length



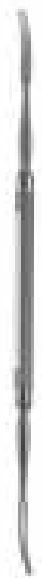
Freer Septum Elevator,
Double Ended, Sharp /
Blunt, Wide, 6.5mm Width,
09-080 197mm Length



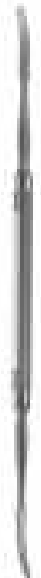
Hajak Ballenger Septum Elevator, Double Ended,
8.5mm Width
09-081 191mm Length



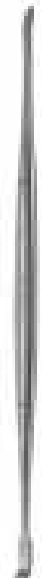
Freer Septum Elevator,
Curved, Double Ended,
5mm Width
09-082 191mm
Length



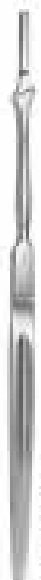
Kilian Septum Elevator,
Double Ended, 4 mm
With 3.4 Mm Taper, And
4.3 Mm With 3mm Taper,
09-083 184mm Length



Kilian Septum Elevator,
Double Ended
09-084 229mm Length,
6mm With 4.5 Mm Taper
And 4.3mm With 3mm Taper



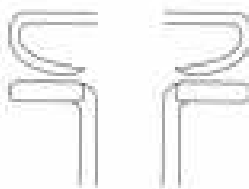
Howard Septum Elevator,
Double Ended, 5mm Width
09-085 216mm Length



Gruber Combination
Knife Handle
/ Perichondrium Elevator #7
09-086 165mm Length,
10/15c Blade Size



Obwegeser Rib Raspatory,
09-087 30cm, Left
09-088 30cm, Right



Joseph Masing
Septum Raspatory,
09-089 22cm, 4mm,
Sharp



Cottle Periosteal
Elevator/Raspatory,
09-090 18cm,
8mm, Sharp





Max Breast Retractor,
09-091 27cm, 125 X 30mm
09-092 27cm, 140 X 30mm

Ferrera Style Retractor, With Fiber Optic Light Guide

With Smoke Tube

- 09-093** 70 X 16 mm
- 09-094** 80 X 16 mm
- 09-095** 90 X 27 mm
- 09-096** 110 X 25 mm
- 09-097** 120 X 25 mm
- 09-098** 130 X 16 mm
- 09-099** 130 X 25 mm
- 09-100** 150 X 25 mm
- 09-101** 150 X 30 mm
- 09-102** 150 X 36 mm
- 09-103** 180 X 16 mm
- 09-104** 180 X 25 mm
- 09-105** 190 X 25 mm
- 09-106** 190 X 36 mm
- 09-107** 220 X 27 mm

Without Smoke Tube

- 09-108** 70 X 16 mm
- 09-109** 80 X 16 mm
- 09-110** 90 X 27 mm
- 09-111** 110 X 25 mm
- 09-112** 120 X 25 mm
- 09-113** 130 X 16 mm
- 09-114** 130 X 25 mm
- 09-115** 150 X 25 mm
- 09-116** 150 X 30 mm
- 09-117** 150 X 36 mm
- 09-118** 180 X 16 mm
- 09-119** 180 X 25 mm
- 09-120** 190 X 25 mm
- 09-121** 190 X 36 mm
- 09-122** 220 X 27 mm



Breast Spatula With Handle
09-123 31.5cm, 25mmX18cm
 Blade, Serrated Tip, Semi Malleable



Wieder Breast And Facial Retractor /
 Tongue Depressor, Serrated,
09-124 14cm, 28mm, With Fiber Optic Light Guide
09-125 14cm, 38mm, With Fiber Optic Light Guide
09-126 15cm, 45mm, With Fiber Optic Light Guide



Wieder Breast And Facial Retractor /
 Tongue Depressor, Serrated,
09-127 14cm, 28mm
09-128 14cm, 38mm
09-129 15cm, 45mm



Breast Retractor, Double Ended,
09-130 31cm,
 Blades 22mm X 55mm and 38mm x 70mm
09-131 24cm,
 Blades 22mm x 55mm and 38mm x 70mm



Biggs Mammoplasty Retractors.

09-132 30mm

09-133 50mm

With Fiber Optic Light Guide

09-134 30mm,

09-135 50mm,

With Fiber Optic Light Guide And Suction



Biggs Mammoplasty Retractor,

09-136

50mm Width, Standard,

20cm Length



09-137 Biggs Mammoplasty Retractor,

With Fiber Optic Light Guide 5.0cm

Blade Width, 20cm Length



09-138 Biggs Mammoplasty Retractor,

3cm Blade Width, Narrow,

171mm Length



09-139 Biggs Mammoplasty Retractor,

With Fiber Optic Light Guide,

Narrow, 3.0cm Blade Width,

15cm Length



09-140 Ferreira Breast Augmentation Retractor,

25x171cm Blade, 130mm Handle Length



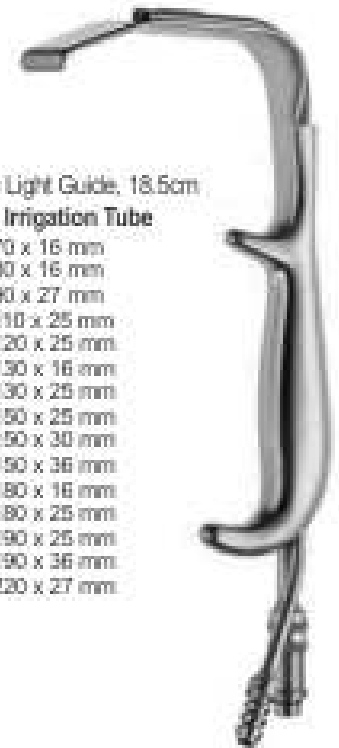
09-141 Femora Breast Augmentation Retractor, With Fiber Optic Light Guide, 25 X 171 Mm Blade Width, 130 Mm Handle Length Width

Tebbetts Retractor With Fiber Optic Light Guide, 18.5cm
With Irrigation Tube

- 09-142 70 X 16 mm
- 09-143 80 X 16 mm
- 09-144 90 X 27 mm
- 09-145 110 X 25 mm
- 09-146 120 X 25 mm
- 09-147 130 X 16 mm
- 09-148 130 X 25 mm
- 09-149 150 X 25 mm
- 09-150 150 X 30 mm
- 09-151 150 X 36 mm
- 09-152 180 X 16 mm
- 09-153 180 X 25 mm
- 09-154 190 X 25 mm
- 09-155 190 X 36 mm
- 09-156 220 X 27 mm

Without Irrigation Tube

- 09-157 70 x 16 mm
- 09-158 80 x 16 mm
- 09-159 90 x 27 mm
- 09-160 110 x 25 mm
- 09-161 120 x 25 mm
- 09-162 130 x 16 mm
- 09-163 130 x 25 mm
- 09-164 150 x 25 mm
- 09-165 150 x 30 mm
- 09-166 190 x 36 mm
- 09-167 180 x 16 mm
- 09-168 180 x 25 mm
- 09-169 190 x 25 mm
- 09-170 190 x 36 mm
- 09-171 220 x 27 mm



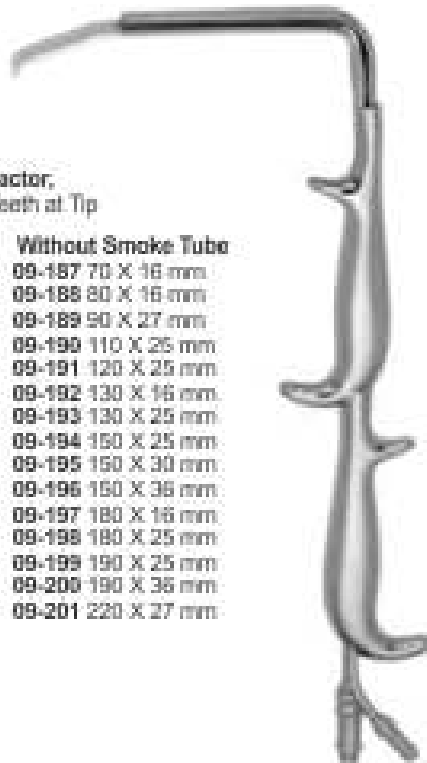
Tebbetts Fiber Optic retractor,
With Double Handle and Teeth at Tip

With Smoke Tube

- 09-172 70 x 16 mm
- 09-173 80 x 16 mm
- 09-174 90 x 27 mm
- 09-175 110 x 25 mm
- 09-176 120 x 25 mm
- 09-177 130 x 16 mm
- 09-178 130 x 25 mm
- 09-179 150 x 25 mm
- 09-180 150 x 30 mm
- 09-181 150 x 36 mm
- 09-182 180 x 16 mm
- 09-183 180 x 25 mm
- 09-184 190 x 25 mm
- 09-185 190 x 36 mm
- 09-186 220 x 27 mm

Without Smoke Tube

- 09-187 70 X 16 mm
- 09-188 80 X 16 mm
- 09-189 90 X 27 mm
- 09-190 110 X 25 mm
- 09-191 120 X 25 mm
- 09-192 130 X 16 mm
- 09-193 130 X 25 mm
- 09-194 150 X 25 mm
- 09-195 150 X 30 mm
- 09-196 150 X 36 mm
- 09-197 180 X 16 mm
- 09-198 180 X 25 mm
- 09-199 190 X 25 mm
- 09-200 190 X 36 mm
- 09-201 220 X 27 mm



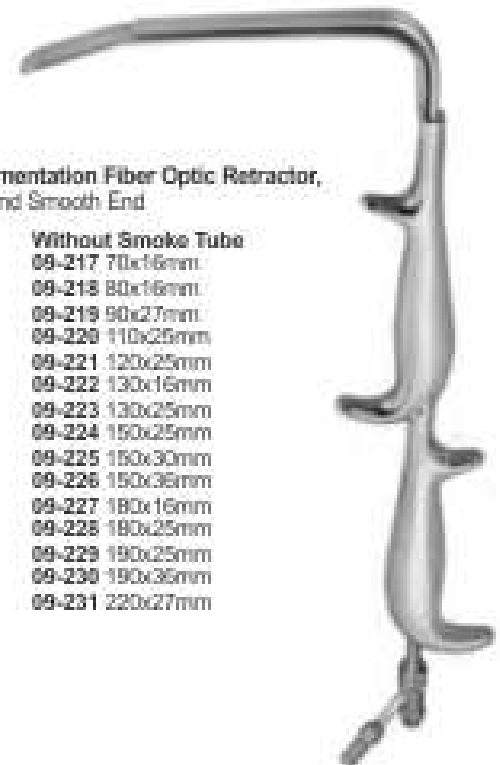
Tebbetts Breast Augmentation Fiber Optic Retractor,
With Double Handle And Smooth End

With Smoke Tube

- 09-202 70x16mm
- 09-203 80x16mm
- 09-204 90x27mm
- 09-205 110x25mm
- 09-206 120x25mm
- 09-207 130x16mm
- 09-208 130x25mm
- 09-209 150x25mm
- 09-210 150x30mm
- 09-211 150x36mm
- 09-212 180x16mm
- 09-213 180x25mm
- 09-214 190x25mm
- 09-215 190x36mm
- 09-216 220x27mm

Without Smoke Tube

- 09-217 70x16mm
- 09-218 80x16mm
- 09-219 90x27mm
- 09-220 110x25mm
- 09-221 120x25mm
- 09-222 130x16mm
- 09-223 130x25mm
- 09-224 150x25mm
- 09-225 150x30mm
- 09-226 150x36mm
- 09-227 180x16mm
- 09-228 180x25mm
- 09-229 190x25mm
- 09-230 190x36mm
- 09-231 220x27mm





Tebbetts Breast Augmentation Fiber Optic Retractor, Insulated Blade With Smooth End, 18.5 Cm

With Smoke Tube

- 09-232 70x16mm
- 09-233 80x16mm
- 09-234 90x27mm
- 09-235 110x25mm
- 09-236 120x25mm
- 09-237 130x16mm
- 09-238 130x25mm
- 09-239 150x25mm
- 09-240 150x30mm
- 09-241 150x36mm
- 09-242 180x16mm
- 09-243 180x25mm
- 09-244 190x25mm
- 09-245 190x36mm
- 09-246 220x27mm

Without Smoke Tube

- 09-247 70x16mm
- 09-248 80x16mm
- 09-249 90x27mm
- 09-250 110x25mm
- 09-251 120x25mm
- 09-252 130x16mm
- 09-253 130x25mm
- 09-254 150x25mm
- 09-255 150x30mm
- 09-256 150x36mm
- 09-257 180x16mm
- 09-258 180x25mm
- 09-259 190x25mm
- 09-260 190x36mm
- 09-261 220x27mm



Tebbetts Fiber Optic retractor, Insulated Blade With Teeth 18.5cm

With Smoke Tube

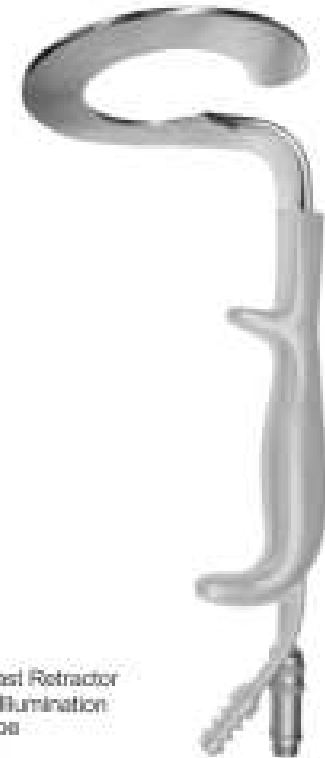
- 09-262 70x16mm
- 09-263 80x16mm
- 09-264 90x27mm
- 09-265 110x25mm
- 09-266 120x25mm
- 09-267 130x16mm
- 09-268 130x25mm
- 09-269 150x25mm
- 09-270 150x30mm
- 09-271 150x36mm
- 09-272 180x16mm
- 09-273 180x25mm
- 09-274 190x25mm
- 09-275 190x36mm
- 09-276 220x27mm

Without Smoke Tube

- 09-277 70x16mm
- 09-278 80x16mm
- 09-279 90x27mm
- 09-280 110x25mm
- 09-281 120x25mm
- 09-282 130x16mm
- 09-283 130x25mm
- 09-284 150x25mm
- 09-285 150x30mm
- 09-286 150x36mm
- 09-287 180x16mm
- 09-288 180x25mm
- 09-289 190x25mm
- 09-290 190x36mm
- 09-291 220x27mm



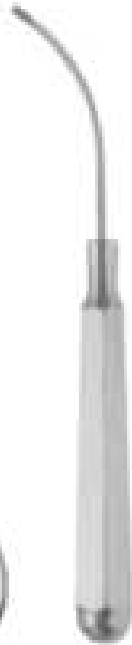
Sculpo Breast Retractors, 180 X 25mm Blade Size, With
09-292 5mm Endoscopic Scope Sheath
09-293 10mm Endoscopic Scope Sheath



09-294 Ring Breast Retractor With Fiber Optic Illumination And Irrigation Tube



Alsch Forceps,
09-295 16cm,
5mm Tip



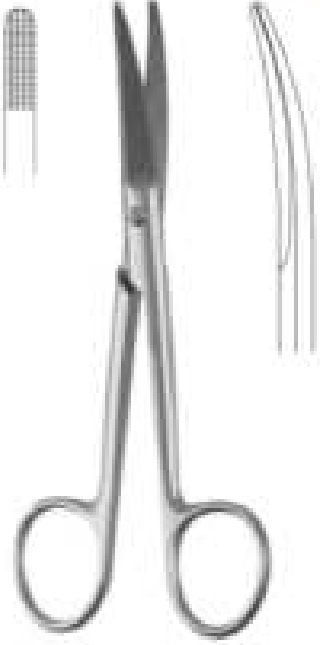
Dingman Cartilage
Abraders,
Set of Two
09-296



Rubin Septal Morselizer
Forceps,
09-297 21cm



Rubin Septal Morselizer
Forceps,
T.C. (tungsten Carbide)
09-298 20cm



Mayo Scissors,
Supercut Plus T.C.
(tungsten Carbide)
09-299 17cm, Curved



Cottle Cartilage Crusher, With Clamp, For
Taking Out The Prepared Material,
09-300 65x30x30mm



Gubisch Cartilage Crusher
09-301 65x30mm



Cartilage Cutting Block, Teflon,
09-302 85x55x10mm



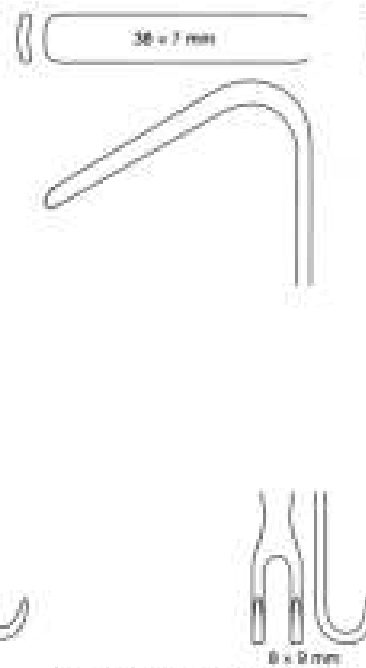
Bone Mill, With Assembling Wrench
09-303



Auricht Nasal Retractor,
09-304 18cm
45x7-10mm



Auricht Nasal Retractor
Double Ended, Blunt,
09-305 13.5cm
282-38x7mm



Auricht Walter Nasal Retractor
Double Ended, Blunt,
09-306 13.5cm
283-38x7mm



Auricht Walter Nasal Retractor
Double Ended, Sharp,
09-307 13.5cm
284-42x7mm



Cottle Ailar Retractor,
09-308 15cm,
22x13mm



Walter Ailar And Nasal Retractor
With Fiber Optic Illumination,
09-309 18.5cm



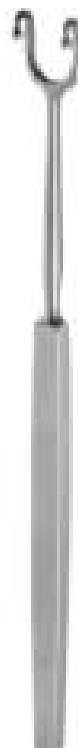
Gubisch Auricht
Nasal Retractor,
09-310 17cm,
50x8-12mm



Aufrecht Nasal Retractor
 09-311 15cm
 7mm Tip, 45mm
 Blade, With Fiber Optic
 Light Guide
 09-312 18cm 10mm



Converse Blade Nasal Retractor
 09-313 20mm X 10mm Wide,
 With Fiber Optic Light Guide
 09-314 30mm X 12mm Wide,
 09-315 40mm X 12mm Wide,
 09-316 50mm X 12mm Wide,



Formon Nasal Retractor
 09-317 1 Ball End Prong
 15cm
 09-318 2 Ball 15cm



Killian-Nasal Speculum
 With Fiber
 Optics Illumination
 09-319



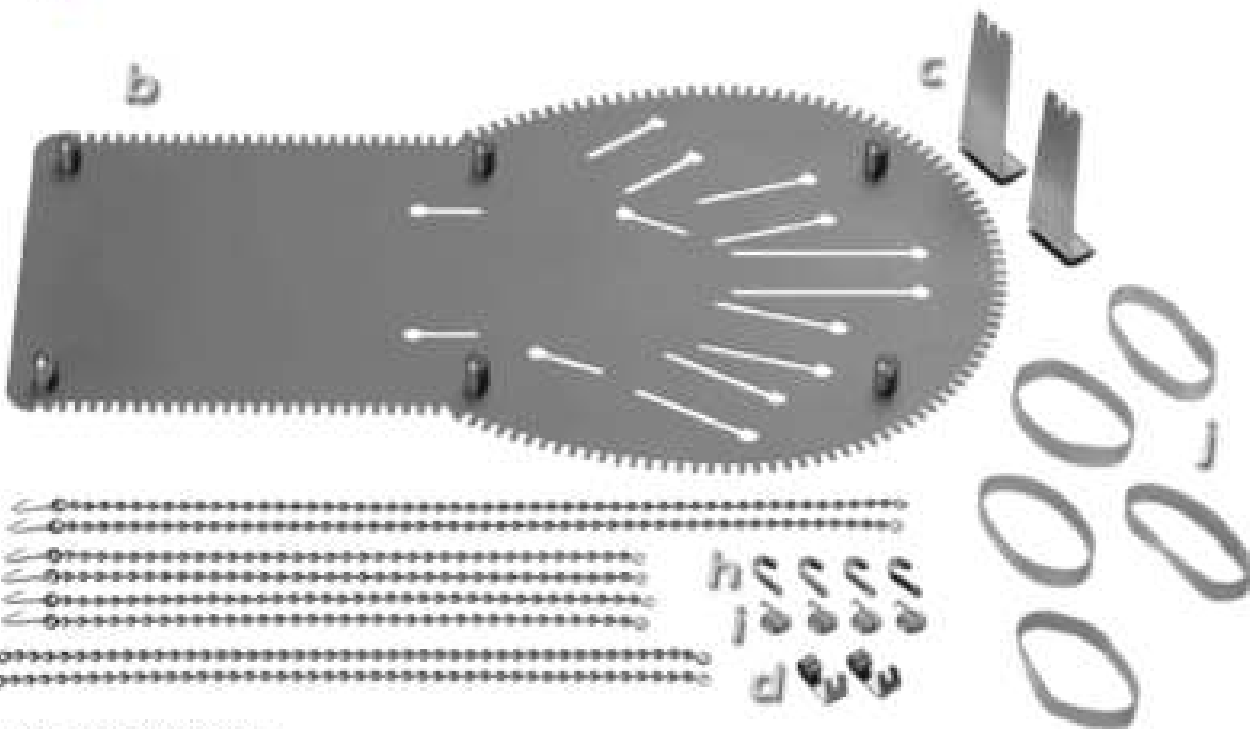
Joseph Nasal Saw
 09-320 17cm,
 Straight



Joseph Nasal Saw
 09-321 17cm, Left
 09-322 17cm, Right



Joseph Nasal Saw
 09-323 Angled To Left
 09-324 Angled To Right



Tuppers Hand Retractor Set
 09-325 Medium
 09-326 For Infants
 09-327 For Adults



Obwegeser Alveolar
(wisdom Tooth) Retractor,
 09-328 22cm, 13/23 X 70mm



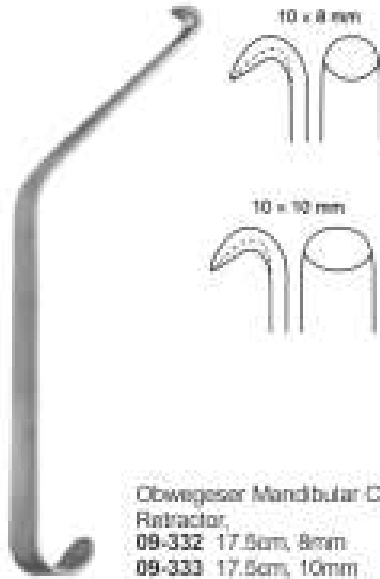
Obwegeser Nasal Spine Retractor,
 09-329 22cm, 10/23 X 45mm



Obwegeser Iliac
 Crest Retractor
 09-330 22cm
 30/60 X 60mm



Obwegeser Iliac
 Crest Retractor
 09-331 22cm
 30/60 X 80mm



Obwegeser Mandibular Channel Retractor
09-332 17.5cm, 8mm
09-333 17.5cm, 10mm



Obwegeser Chin Retractor
09-334 16cm



Saldanha Solz Abdominal Retractor
09-335 23.5cm



Kilian Nasal Speculum With Fiber Optics Illumination
09-336



Deaver Retractor With Fiber Optics
09-337 Illumination, 16mm
09-338 Illumination, 25mm



Femora Face Lift Retractor With Fiber Optic Illumination 22 X 108mm
09-339



Freeman Flap Retractor With Fiber Optics Illumination
09-340 20cm, 13mm
09-341 20cm, 25mm



09-342 Mandibular Channel Retractor
8mm, 17.5cm



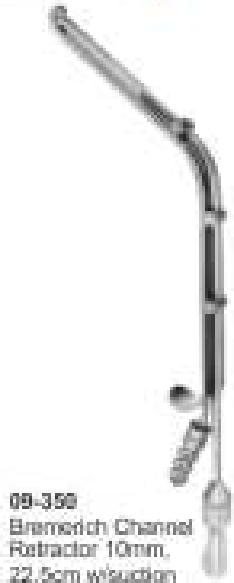
09-343 Bremnerich Mandibular Channel Retractor
10mm, 18cm



09-344 Ramus Retractor 20x80mm
16cm
09-345 Ramus Retractor 25x80mm
16cm
09-346 Ramus Retractor 30x80mm
16cm
09-347 Ramus Retractor 35x80mm
16cm



09-348 Medial Ramus Retractor left 19.5cm
09-349 Medial Ramus Retractor right 19.5cm



09-350
Bramerich Channel
Retractor 10mm,
22.5cm w/suction



09-351
Extra Oral
Retractor
24cm



09-352
Intra Oral
Retractor
24cm



09-353
Intra Oral
Retractor
L and M
w/o F/O
fitting,
25cm



09-354
Intra Oral
Retractor
right w/o
F/O fitting,
21cm



09-355
Intra Oral
Retractor
left w/o
F/O fitting,
21cm



09-356
Intra Oral Retractor
w/o F/O
Fitting, 23cm



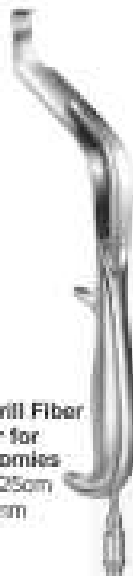
09-357
Intra Oral Retractor
With
F/O fitting 23cm



09-358
Intra Oral Retractor
Left
with F/O fitting
21cm



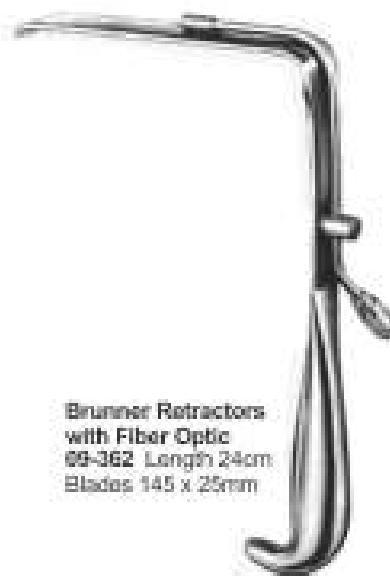
09-359
Intra Oral Retractor
right
w/F/O fitting, 21cm



**Levasseur Merrill Fiber
Optic Retractor for
Vertical Osteotomies**
09-360 Length 25cm
Working Tip 27mm



**Shea with Fiber Optic
(Multipurpose Retractor)**
09-361 Length 25cm
Working Tip 14.5mm



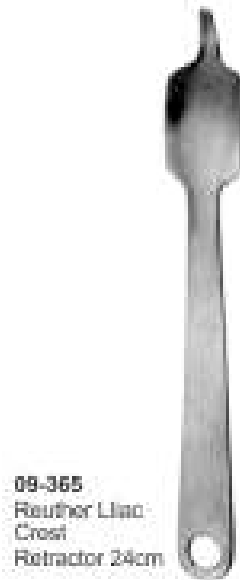
**Brunner Retractors
with Fiber Optic**
09-362 Length 24cm
Blades 145 x 25mm



09-363
Cheek and Lip
Retractor D/E
21x30mm,
26x35mm, 18cm



09-364
Schwenger Cheek
Retractor 65x50mm,
17cm



09-365
Reuther Lipo-
Cross
Retractor 24cm



09-366
Tosker Fib-Graft
Retractor adult
120x28mm, 20.5cm



09-367
Lester
Retractor



09-368
Richardson Retractor
28x20mm



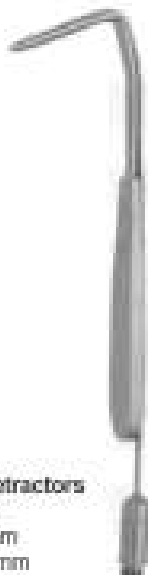
09-369
Richardson Retractor
38x28mm



09-370
Richardson Retractor
38x37mm



09-371
Richardson Retractor
52x22mm



**Aufich Nasal Retractors
with Fiber Optic**
09-372 15cm 7mm
09-373 18cm 10mm



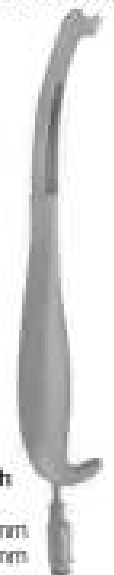
**Harrington Retractors
with Fiber Optic**
09-374 40 x 127mm
09-375 60 x 127mm

for Right cheek



**Bauer Retractor with
Fiber Optic**
09-376 26.5cm / 18mm
09-377 26.5cm / 18mm

for Left cheek





Petri Pterygoid Retractor with Fiber Optic
09-378 23cm, 25.5mm



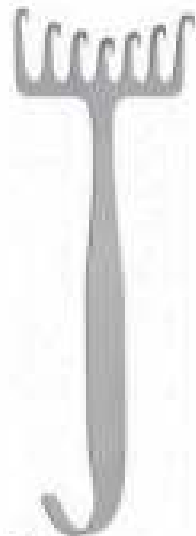
Sigmoid Nptch Retractor with Fiber Optic
09-379 22cm, 15mm



Malinlac Nasal Retractor with Fiber Optic
09-380 9mm x 45mm



09-381
Yancoeskie Retractor
18cm, 6 sharp prongs

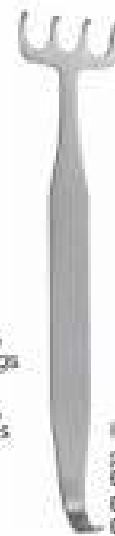


09-382
Coronel Brow Lift Retractor
18cm, 7 Sharp prongs

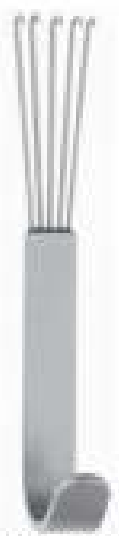


Freeman Retractor

09-383 18cm,
4 Sharp prongs
22mm, wide
09-384 18cm,
4 Blunt prongs
22mm, wide



Hook Retractor in-line prongs / four prongs 18cm
09-385 straight
09-386 narrow head
09-387 angled shaft
09-388 angled shaft 4 prong with shorter inner prongs 18cm



Anderson Bear Claw Retractor
09-389 12cm



Miniature model / with thumb ring / in-line prongs / four prongs
09-390 6cm

Miniature model / with thumb ring / in-line prongs / four prongs
09-391 11.5cm



Freeman Hook Retractor four Prongs / with shorter inner prongs / seven prongs
09-392 18 cm



Freeman Hook Retractor Seven Prongs / with shorter inner prongs / seven prongs
09-393 18 cm concave

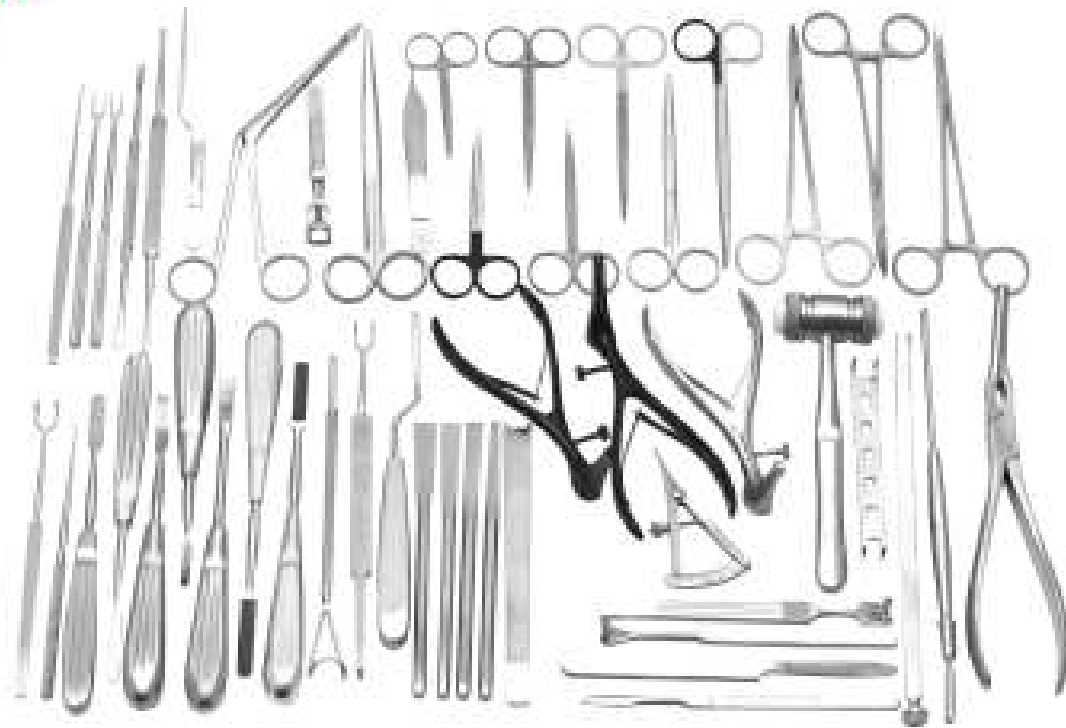


Freeman Hook Retractor Seven Prongs / with shorter inner prongs / seven prongs
09-394 18 cm convex



**Rhinoplasty set
09-395**

01. Scalpel Handle, #7k.
02. Surgical Operating Scissors, 14.5cm, Curved - Sharp/Blunt
03. Regnell Kliner Scissors, 15cm, Curved - Flattened At Distal End
04. Fox T.C. Gum And Tissue Scissors, 13cm, Curved, 1 Serrated Blade
05. Adson Brown Delicate Tissue Forceps, 12cm, 7x7 Teeth, Straight
06. Adson Brown Delicate Tissue Forceps, 12cm, 9x9 Teeth, Straight
07. Semken Delicate Tissue Forceps, 12.5cm, 2x3 Teeth, Straight
08. Debakay At Vascular Forceps, 15cm - 1.5mm Tips
09. Bayonet Grasping Forceps, 16cm
10. Bayonet Grasping Forceps, 16cm, 1x1 Teeth
11. Trostsch Wide Angular Forceps, 13cm, Adult Size - Serrated
12. Grooved Director And Tongue Tie, 11.5cm
13. Frazier Ferguson Suction Tube, 18cm, Angled, 10 French e
14. Sennig T.C. Needle Holder, 17cm, Serrated
15. Halsted Micro Mosquito Forceps, 12.5cm, Curved
16. Backhaus Towel Clamp, 8.5cm
17. Gross Dressing Forceps, 20cm, Straight - Without Catch, Box Lock
18. Walter Cope Retractor, 17.5cm
19. Joseph Skin Hook, 16cm, Single Prong, Sharp
20. Guthrie Double Retractor Hook, 13cm, 2mm Wide, Sharp
21. Lempert Raspatory, 17cm, 4mm, Delicate, Sharp
22. Supercut Walter Dorsal Scissors, 14cm, Angular
23. Supercut Walter Cottle Dorsal Scissors, 16cm, Curved
24. Medicon Mallet, 18.5cm, Plastic Facings, 200 Grams, 25mm Diameter
25. Walter Williger Bone Curette, 13.5cm, 2/2mm, Double Ended, Sharp, Angled
26. DeFoumenet Bone Rongeur, 19cm, Straight, Slender Beaks - Jaws 3mm Wide
27. Weil Blakesley Wide Ethmoid Bone Forceps #3, 120mm Shaft, 4.2mm
28. Weil Blakesley Wide Ethmoid Bone Forceps #2, 45 Degree Angle, 120mm Shaft, 3.6mm
29. Myles Nasal Through Cutting Forceps #4, 120mm Shaft
30. Cottle Nasal Septum Speculum, 14cm, 50mm
31. Cottle Elevator, 16cm, 2.5mm
32. Masing Septum Elevator, 22cm, 5/5mm, Double Ended
33. Aufricht Walter Nasal Retractor, 13.5cm, Double Ended, Sharp, 42x7mm
34. Aufricht Walter Nasal Retractor, 13.5cm, Double Ended, Blunt, 38x7mm
35. Walter Chisel/Osteotome, 19cm, 3mm, Modified
36. Walter Chisel/Osteotome, 19cm, 5mm, Modified
37. Walter Osteotome, 19cm, 2mm, Straight
38. Walter Osteotome, 19cm, 12mm, Straight
39. Walter Chisel/Osteotome, 19cm, 12mm, Modified
40. Walter Osteotome, 19cm, 6mm, Curved
41. Walter Cantanans Lifting Scissors, 16cm, Curved
42. Fomon Rhinoplasty Scissors, 12.5cm
43. Cottle Columella Forceps, 11cm
44. Fomon Bone And Nasal Rasp, 20cm
45. Asch Septum Straightening Forceps, 22cm, Angled
46. Brunings Tongue Depressor, 19cm, 14mm



**Rhinoplasty set
88-396**

Steel Ruler 6"	1
Metz Lahrey Crv Del 5 3/4" Tc	1
Metz Sciss-Ovd Del 7" Tc	1
Crile-Wood Nh Serr 7" Tc	1
Mallet WRapl Pst Discs	1
Maltz Rasp 7" Bkd Cut	1
Joseph Rasp Fine Crs Serr 6 1/4"	1
Upright Glabelar Rasps 8" Bkd	1
Cottle Dorsal Sciss Ang 6 1/2"	1
Black Cotted Cottle Septal Spec 2"	2
Cottle Elev Crv-Grad D/E 9	1
Joseph Perio Elev 7" X3.5Mm	1
Joseph Perio Elev 6 1/4" X4.5Mm	1
Cottle Nasal Knife Sh 5 1/2" 4Mm	1
Cottle Nasal Osteo 6 1/2" Ovd	1
Cinelli Osteo Grd 25d Str 10Mm	1
Cot Knife Grd/Retr 6" 5Mm Hook	1
Nasv Knife Gd/Retr 6 1/2" D-End	1
Cottle Ret 5 1/2" 4Prng 2Races	1
Fomon Retr-Ball End Dbl 6 1/4"	1
Converse Alar Retr D/E 4 1/2"	1
Iris Sciss Str 5/5 3 1/2"	1
Freer Elevator De Sh/B 7 1/4"	1
Joseph Hook 1/Pr Sh 6 1/4"	1
Joseph Hook 2/Pr Sh 6 1/4" 5Mm	2
Gillies Skin Hook 7" 3Mm	1
Adson Dressing Fcp Serr 434"	1
Strabismus Sciss Str 4 1/2"	1
Strabismus Sciss Crv 4 1/2"	1
Deornames Lid Retr 12Mm	1
Castrojejo Catper 3 1/4"	1
Cottle Columella Fcp 4 1/2"	1
Hartman Ear Fcp Light Serr Jaw	1
Jansen-Nasal Fcp Bayonet 6 1/2"	1
Sheehan Osteo Str 6 1/4" 4Mm	1
Sheehan Osteo Str 6 1/4" 5Mm	1
Sheehan Osteo Str 6 1/4" 10Mm	1
Sheehan Osteo Str 6 1/4" 12Mm	1
Killian Med W/Set Screw 3"	1
Fomon Nas Low Lat Scis Cv 534"	1
Ash Sept Straightening Fcp 9"	1
Balfanger Seivel Knife 4Mm	1
Joseph Bone Saw Str 7 1/2"	1
Schmidt Half Crv Tons Fcp 7 1/2"	2
Maltz Rasp Se Fine Tc	1
Maltz Rasp Se-Medium Tc	1



Rhinoplasty set

09-397

01. Scalpel Blades #15 - Sterile,
02. Scalpel Handle, #7
03. Surgical Operating Scissors, 13cm, Straight - Sharp/Blunt
04. Mayo Style T.C. Operating Scissors, 17cm, Curved
05. Reynolds Jameson Scissors, 14cm, Curved - With Fine, Rounded Points
06. Adson T.C. Tissue Forceps, 12cm
07. Micro Adson Forceps, 12cm, 1x2 Teeth - 0.8mm Tips
08. Adson Brown Delicate Tissue Forceps, 12cm, 7x7 Teeth, Straight - Atraumatic
09. Dressing Forceps, 20cm - Modified Swedish Pattern
10. Nelson Tissue Forceps, 15cm
11. Gruenwald Jansen Nasal Dressing Bayonet Forceps, 16cm, Serrated
12. Gubisch T.C. Needle Holder, 12.5cm, Extra Fine
13. Crile Wood T.C. Needle Holder, 15cm
14. Halsted Micro Mosquito Forceps, 12.5cm, Curved
15. Leriche Artery Forceps, 15cm, 1x2 Teeth, Straight
16. Pean Hemostatic Forceps, 14cm, Straight
17. Backhaus Towel Clamp, 13cm
18. Dressing Forceps, 17.5cm, Curved, Delicate
19. Gross Dressing Forceps, 20cm, Curved - With Catch, Box Lock
20. Barsky Skin Hook, 15cm, Single Prong, Sharp
21. Joseph Delicate Retractor, 17cm, 2 Prong, 5mm, Sharp
22. Guthrie Double Retractor Hook, 13cm, Sharp
23. Supercut Plus T.C. Mayo Scissors, 14cm, Straight
24. Supercut Plus T.C. Mayo Scissors, 17cm, Curved
25. Supercut Plus Metzenbaum T.C. Scissors, 18cm, Curved
26. Supercut Plus Kelly T.C. Scissors, 16cm, Curved
27. Langenbeck Bone Elevator, 20cm, 7mm, Blunt
28. Freer Raspatory, 19cm, 5/5mm, Double Ended, Sharp / Sharp
29. Williger Raspatory, 16cm, 5mm, Sharp
30. Mokeny Raspatory, 15cm, 4mm, Sharp, Light Curve
31. Supercut Heymann Nasal Scissors, 18cm
32. Supercut Plus Fomon T.C. Dorsal Scissors, 13cm, Angular
33. Mallet, 26cm, Novolox Plastic, 240 Grams, 45mm Diameter
34. Round Bowl For Solutions, 40x20mm, 20cc
35. Round Bowl For Solutions/Marking Color, 60x30mm, 60cc
36. Round Bowl For Solutions, 80x40mm, 160cc
37. Round Bowl For Solutions, 110x55mm, 400cc
38. Castroviejo Caliper, 7cm, 20mm Measuring Range
39. Desmarres Lid Retractor #2, 14cm, Medium, 10x14mm
40. Killian Assept Nasal Speculum, #4, 90mm (Modified)
41. Weil Blakesley Wide Ethmoid Bone Forceps #3, 120mm Shaft, 4.2mm
42. Freer Septum Knife (Mucosa Scalpel), 15cm
43. Cottle Nasal Speculum, Delicate, 15cm, 55mm
44. Gubisch Suction Raspatory With Guide And Bypass Hole, 20cm, 4mm
45. Gubisch Suction Raspatory With Guide, 17cm, 4mm
46. Cartilage Cutting Block, Teflon, 85x55x10mm
47. Gubisch Cartilage Crusher, 65x30mm
48. Gubisch Kilner Double Nasal Hook (Alar Retractor), 8cm, Sharp, 5x10mm
49. Gubisch Aufrecht Nasal Retractor, 17cm, 50x5-12mm
50. Cottle Gubisch Chisel, 18cm, 5mm, Graduated, Hollow Cut
51. Cottle Gubisch Chisel, 18cm, 12mm, Graduated, Hollow Cut
52. Gubisch Osteotome, 18.5cm, 3mm, Aluminium Handle
53. Fanous Osteotome, 19.5cm, 4mm, Straight, With Guide Thom - 1
54. Caplan Nasal Septum Scissors, 20cm, Serrated
55. Gubisch Fomon Nasal Rasp, 20cm
56. Rubin Septal Morselizer Forceps, 20cm, With Protective Guard
57. Buchwald Tongue Spatula, 18cm, 18x23mm



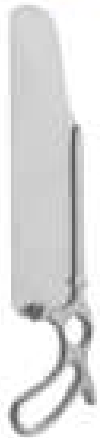
Rhinoplasty set

89-398

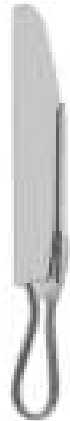
- Adson Forceps TC, Serrated, 13cm 2
- Aston SuperCut Scissors, 5 1/2" (14cm), Angled, Serrated 1
- Aulricht Nasal Retractor with Fiber Optic Light Guide, 7" (18cm), 1.75in Tapered 1
- Backhaus Towel Forceps, 3 1/2" (9cm) 2
- Beasley-Babcock Forceps, 4 3/4" (12cm), 3.5mm tips 1
- Bishop-Harmon Forceps, 3 1/2" (9cm), 1x2 teeth, 0.6mm tips 2
- Boies Nasal Fracture Elevator, 7 3/4" (19.5cm) 1
- Brown-Adson Forceps, 4 3/4" (12cm), Brown teeth 1
- Caplan Nasal Shears Scissors, 7 3/4" (19.5 cm), Angled, Serrated 1
- Castroviejo Caliper, 3 1/2" (9cm) 1
- Cottle Cartilage Crusher Morselizer 1
- Cottle Double-Ended Septum Elevator, 8 1/2" (21cm), 4mm/3mm, Sharp/Blunt 1
- Cottle Modified Nasal Speculum, 5 1/2" (14cm), 50mm 1
- Cottle Retractor, 5 1/2" (14cm), 2 Sharp Prongs 1
- Cushing Bayonet Insulated Bipolar Forceps, 7 1/4" (18.5cm), 1mm tips, American Pattern 1
- Fosterer Sponge Holding Forceps, 7" (18cm) 1
- Fomon TC Rasp, 8 1/2" (21.5cm), #3 & #4, Double 1
- Fomon TC Rasp, 8 1/2" (21.5cm), #5 & #6, Double 1
- Fomon TC Rasp, 8 1/2" (21.5cm), #7 & #8, Double 1
- Frazier Suction Tubes 10 French 2
- Frazier Chisel, 6 1/2" (17cm), 4mm 1
- Gerzog Stainless Steel Mallet (Lead Filled) 1
- Goldman Septum Elevator, 7 1/4" (18.4cm), 6mm 1
- Gunter Lower Lateral Longitudinal Jaw Morselizer, 7" (18cm) 1
- Guthrie Double Hook, 4 3/4" (12cm), 2.5mm 2
- Halsey Needle Holder, 5" (13cm), Delicate, Smooth Jaw 2
- Halfhead Mosquito Forceps, Curved, 5" (12.5cm) 1
- Iris SuperCut Scissors, 4 1/2" (11.5 cm), Curved, Serrated 1
- Janson Middleton Forceps, 7 3/4" (19.5cm), Large Finestrated jaw 1
- Joseph Nasal Saw Left Bayonet, 7 1/4" (18.5 cm) 1
- Joseph Nasal Saw Right Bayonet, 7 1/4" (18.5 cm) 1
- Joseph Periosteal Elevator, 5 1/2" (16.5cm) 1
- Joseph Skin Hook, 6 1/4" (16cm), 10mm Double Hook 1
- Joseph Skin Hooks, 6 1/4" (16cm), 5mm Double Hook 1
- Joseph Skin Hooks, 6 1/4" (16cm), Single Hook 2
- Knife Handle #3, 5" (12.5 cm) for B-P (10-15) blades 4
- Lampert Rongeur, 6 1/4" (16cm), 2.5mm tips 1
- Luciae Nasal Dressing Forceps, 5 1/2" (14cm), Serrated jaw 1
- Mitchell's Trimmer Double-Ended Elevator, 6 5/8" (17cm) 1
- Operating Sharp/Blunt TC Scissors, 5 1/2" (14 cm), Straight 1
- Paon Hemostatic Forceps, Straight, 6 1/4" (16cm) 2
- Pennington Double-Ended Elevator, 8 1/2" (22cm), 4mm/4.5mm 1
- Ribbon Suture Scissors, 3 3/4" (9.5 cm), Curved 1
- Senn Double-Ended Blunt Retractor, 5 1/4" (16cm), blade 1/4in x 3 sharp prongs 2
- Sheen Cartilage Grid 1
- Sheen Fragment Forceps, 7" (18cm) 1
- Silver Osteotome, 7" (18cm) Left 1
- Silver Osteotome, 7" (18cm) Right 1
- Silver Osteotome, 7" (18cm) Straight 1
- Spencer Stitch Removal Scissors, 3 1/2" (9 cm), Straight 1
- Strabismus SuperCut Scissors, 4 1/2" (11.5 cm), Curved, Serrated 1
- SuperCut Scissors, 7 1/2" (19cm), Angled, Serrated 1
- Walsham Septal Forceps, 5" (23cm), 7mm x 33mm Jaws 1
- Webster Glabella TC Rasp, 8 1/2" (21.5cm), Coarse, Push/Pull 1
- Webster TC Needle Holder, 4 1/2" (11.5cm), Delicate, Smooth Jaw 1
- Woodson Double-Ended Elevator, 7" (18cm), straight/angled 1

BONE SURGERY INSTRUMENTS

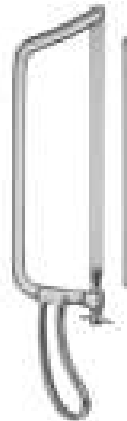




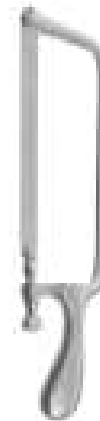
Batterjee Saw
10-001 29cm
 Stainless Steel Ring Handle
 Straight tip, Straight shaft



Charriere Bone Saw
10-002 27cm
10-003 30cm
10-004 34cm
 Straight tip, Straight shaft



Charriere Saw
10-005 35cm
 Spare saw blades
10-006 12mm
10-007 15mm



Charriere Bone Saw Complete
10-008 35.5cm
 Straight tip,
 Straight shaft



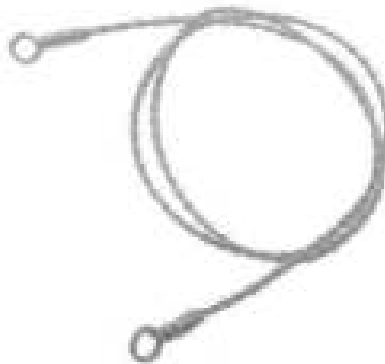
Hefferich-Bier Saw
10-009 39cm
 Spare saw blades
10-010 3mm
10-011 5mm
10-012 5mm



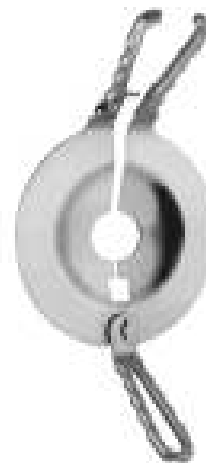
Charriere Saw
10-013 25 cm
10-014 27 cm
 Double saw



Engel Plaster Saw
10-015 15.5 cm



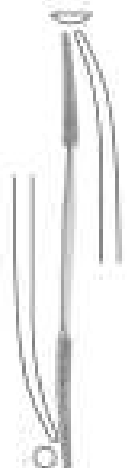
Serra Gigli
10-016 30 cm
10-017 40 cm
10-018 50 cm



Percy Amputation Shield
10-019 30.5cm
 Handles Detachable,
 Simple Pattern



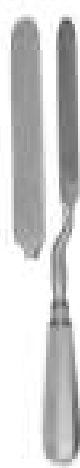
Putti Bone Rasp
10-020 27cm
 Double ended,
 One end curved up
 one end curved sideways



Putti Rasp
10-021 30cm
 Double Ended



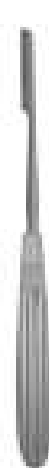
Putti Bone File
10-022 28cm
 semicircular



Putti Bone File
 Bayonet Shape
10-023 24.5cm
 X=13 mm
 semicircular



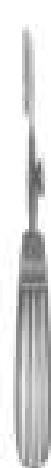
Putti Bone File
10-024 22cm
 X=20 mm
 flat



Joseph Bone Saw / Rasp
10-025 15cm
 Single Sided



Linderman Amputation Saw
10-026 19cm
 20cm Blade



Wellenschiff Nasal Saw
10-027 15cm
 Straight



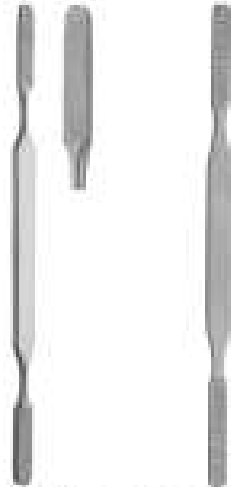
Langenbeck Metacarpal Saw
10-028 23cm
 11.5cm Blade

Knochenfeilen
Limas para huesos

Limes à os
Lime per ossa

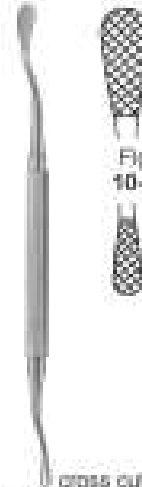


Patella Bone Saw
10-029 Includes 1 blade
10-030 Replacement blade only
Dairn Handle



Foman Rasp
10-031 21.5cm
Double ended, Fine & coarse serrations 4-sided convex and flat blades

Foman Rasp
10-032
21cm



Miller-Colburn Bone File
18 cm



Fig. 1
10-033



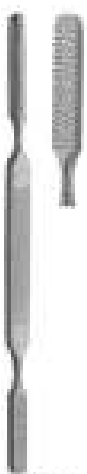
Fig. 2
10-034



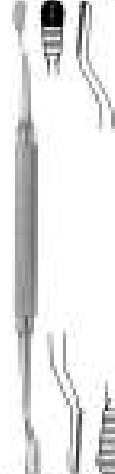
Fig. 3
10-035



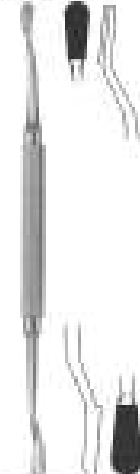
Fig. 4
10-036



Kleinert-Kutz Bone Rasp
10-037 22.5cm
Double ended,
Fine & course serrations



Miller Alveotomy File
10-038 19cm



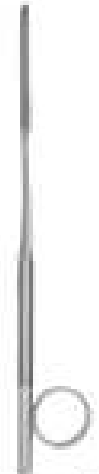
Miller Alveotomy File
10-039 19cm



Gallaher Bone Rasp
10-040 18cm
10-041 25cm
Curved



Gallaher Bone Rasp
10-042 18cm
10-043 25cm
Convex Curve



Gallaher Bone Rasp
10-044 18cm
10-045 25cm
Straight



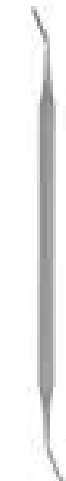
Good Bone File / Rasp
10-046 16.5cm
Straight



Kistler Ear Cartilage Rasp
10-047 left
10-048 right
16.5cm Curved



Micro Rasp
10-049 14cm
Single ended
double sided



Nail Rasp
10-050 17cm
Single sided



Maltz Rasp
10-051 18cm
Single-Ended
Single sided



Improved Maltz Rasp
10-052 18cm
Single-Ended,
up & down rasping



Putti Rasp
10-053 23cm
flat / fat
10-054 30.5cm
Round / flat

Rasps, Felien
Rapes, Limes

Escofinas, limas
Raspe, lime



Miller Rasp
10-055 21.5cm
Double Ended straight
single Sided



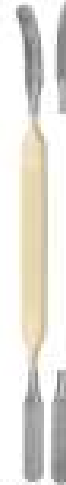
Fomon Rasp
10-056 21.5cm
Double Ended straight
single Sided
one side concave



Fomon Rasp
10-057 21.5cm
Double Ended straight
single Sided
one side convex



Fomon Rasp
10-058 21.5cm
Double Ended straight
single Sided



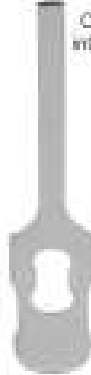
Fomon Rasp
10-059 21.5cm
Double Ended straight
single Sided
one side concave



Fomon Rasp
10-060 21.5cm
Double Ended straight
single Sided
one side convex

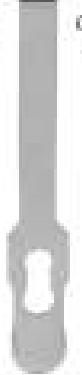


Chisel Blade Handle
10-061 18.5cm



Chisel blades,
interchangeable

10-062 8.5cm
5mm
10-063 8.5cm
10mm
10-064 8.5cm
15mm
10-065 8.5cm
25mm

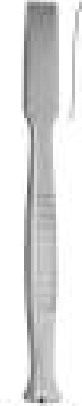


Osteotome blades,
interchangeable

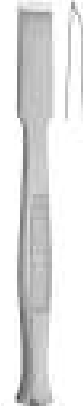
10-066 8.5cm
5mm
10-067 8.5cm
10mm
10-068 8.5cm
15mm
10-069 8.5cm
25mm



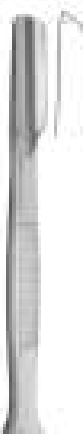
Chisel Blade key
10-070 9cm



Osteotome
13.5cm
10-071 8mm
10-072 10mm
10-073 12mm
10-074 14mm
10-075 16mm



Chisel
13.5cm
10-076 8mm
10-077 10mm
10-078 12mm
10-079 14mm
10-080 16mm



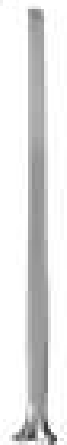
Gouge
13.5cm
10-081 8mm
10-082 10mm
10-083 12mm
10-084 14mm
10-085 16mm



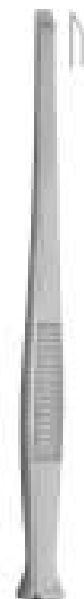
Lucas Chisel
16cm
10-086 3mm
10-087 4mm
10-088 5mm
10-089 6mm



Lucas Gouge
16cm
10-090 3mm
10-091 4mm
10-092 5mm
10-093 6mm



**U.S. Army Pattern
Chisel**
16.5 cm
10-094 6 mm wide
10-095 12 mm wide
10-096 18 mm wide



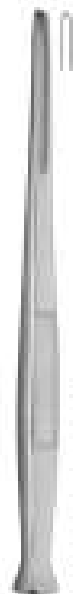
Parsch Chisel	Parsch Chisel	Parsch Chisel
11.5cm	13.5cm	17.5cm
10-097 2mm	10-103 2mm	10-109 2mm
10-098 3mm	10-104 3mm	10-110 3mm
10-099 4mm	10-105 4mm	10-111 4mm
10-100 5mm	10-106 5mm	10-112 5mm
10-101 7mm	10-107 7mm	10-113 7mm
10-102 8mm	10-108 8mm	10-114 8mm

BONE CHISELS & GOUGES

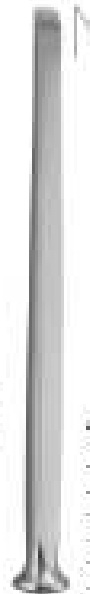


Knochenmeißel
Ciseaux-burins, gouges

Cineles, gubias
Scalpelli, sgorbi

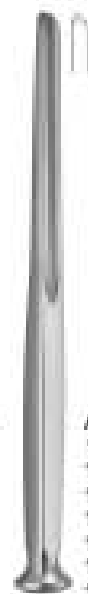


Partsch Gouge 11.5cm	Partsch Gouge 13.5cm	Partsch Gouge 17.5cm
10-115 2mm	10-121 2mm	10-127 2mm
10-116 3mm	10-122 3mm	10-128 3mm
10-117 4mm	10-123 4mm	10-129 4mm
10-118 5mm	10-124 5mm	10-130 5mm
10-119 7mm	10-125 7mm	10-131 7mm
10-120 8mm	10-126 8mm	10-132 8mm



Alexander Chisel
18cm

10-133 4mm
10-134 6mm
10-135 8mm
10-136 10mm
10-137 12mm
10-138 14mm



Alexander Gouge
18cm

10-139 4mm
10-140 6mm
10-141 8mm
10-142 10mm
10-143 12mm
10-144 14mm



Smith Peterson Gouge
20cm Straight:

10-145 09 mm
10-146 14 mm
10-147 19 mm
10-148 25 mm

Curved

10-149 09 mm
10-150 14 mm
10-151 19 mm
10-152 25 mm



Straight

10-153 06 mm
10-154 09 mm
10-155 13 mm
10-156 16 mm
10-157 19 mm
10-158 25 mm
10-159 32 mm

Curved

10-160 06 mm
10-161 09 mm
10-162 13 mm
10-163 16 mm
10-164 19 mm
10-165 25 mm
10-166 32 mm

Smith Peterson Osteotome
20 cm



Straight

10-167 10 mm
10-168 15 mm
10-169 20 mm
10-170 25 mm

Curved

10-171 10 mm
10-172 15 mm
10-173 20 mm
10-174 25 mm

Stille Gouge
20 cm



Stille
20 cm



Stille Chisel
20 cm

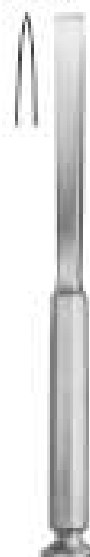


Chisels

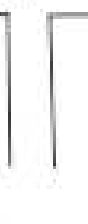
10-175 10 mm
10-176 12 mm
10-177 15 mm
10-178 20 mm
10-179 25 mm

Osteotome

10-180 10 mm
10-181 12 mm
10-182 15 mm
10-183 20 mm
10-184 25 mm



Stille Osteotome
20 cm



Lexer Osteotome
22 cm

10-193 7 mm
10-194 10 mm
10-195 12 mm
10-196 15 mm
10-197 20 mm
10-198 25 mm
10-199 30 mm

Lexer Modif. Osteotome
29 cm

10-200 7 mm
10-201 10 mm
10-202 12 mm
10-203 15 mm
10-204 20 mm
10-205 25 mm
10-206 30 mm



Lexer Modif. Chisel
29 cm

10-207 7 mm
10-208 10 mm
10-209 12 mm
10-210 15 mm
10-211 20 mm
10-212 25 mm
10-213 30 mm

Lexer Chisel
22 cm

10-214 7 mm
10-215 10 mm
10-216 12 mm
10-217 15 mm
10-218 20 mm
10-219 25 mm
10-220 30 mm



Lexer Gouge
25 cm

10-221 7 mm
10-222 10 mm
10-223 15 mm

Straight

*Knochenmeißel
Ciseaux-burins, gouges*

*Cineles, gubias
Scalpelli, sgorbi*



Lexer Gouge
25 cm
10-224 7 mm
10-225 10 mm
10-226 15 mm
Curved



Lexer Osteotome Flat
22 cm
10-227 10 mm
10-228 15 mm
10-229 20 mm
10-230 25 mm



Lexer Gouge Tuffnel Handle
22 cm
10-231 10 mm
10-232 15 mm
10-233 20 mm
10-234 25 mm



Mini Lexer Osteotome
10-235
18 cm



Mini Lexer Chisel
10-236
18 cm



Capener Osteotome With Tuffnel Handle
25cm
10-237 10mm
10-238 12mm
10-239 15mm
10-240 20mm
10-241 25mm
10-242 30mm
Straight



Capener Osteotome With Tuffnel Handle
25cm
10-243 10mm
10-244 12mm
10-245 15mm
10-246 20mm
10-247 25mm
10-248 30mm
Curved



Capener Chisels With Tuffnel Handle
25cm
10-249 6mm
10-250 8mm
10-251 10mm
10-252 12mm
10-253 15mm
10-254 20mm
10-255 25mm
10-256 30mm
Straight



Capener Osteotome With Tuffnel Handle
25cm
10-257 6mm
10-258 8mm
10-259 10mm
10-260 12mm
10-261 15mm
10-262 20mm
10-263 25mm
10-264 30mm
Curved



Raspatories
10-265 20cm
Medium straight blade
round edge, width 14mm



Raspatories
10-266 20cm
Large straight blade
round edge, width 20mm



Raspatories
10-267 20cm
Medium curved blade
round edge, width 14mm



Raspatories
10-268 20cm
Large curved blade
round edge, width 20mm



Mini Lexer Osteotome
10-269 20cm
18mm



Raspatories
10-270
28cm



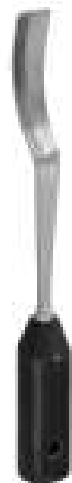
Raspatories
10-271
28cm



Chisel
10-272
115mm/280mm
for extraction of cement

*Knochenmeißel
Ciseaux-burins, gouges*

*Cineles, gubias
Scalpelli, sgorbi*



Chisel
10-273
for extraction
of cement 9mm
Positive 400mm



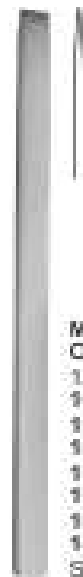
Chisel
10-274
with 2 prong



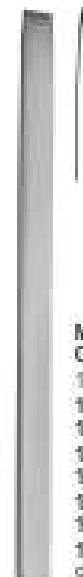
**Lambotte
Osteotome**
25cm
10-275 6mm
10-276 8mm
10-277 10mm
10-278 13mm
10-279 15mm
10-280 20mm
10-281 25mm
10-282 30mm
10-283 38mm
10-284 44mm
10-285 50mm
Straight



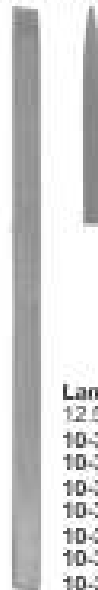
**Lambotte
Osteotome**
25cm
10-286 6mm
10-287 8mm
10-288 10mm
10-289 13mm
10-290 15mm
10-291 20mm
10-292 25mm
10-293 30mm
10-294 38mm
10-295 44mm
10-296 50mm
Curved



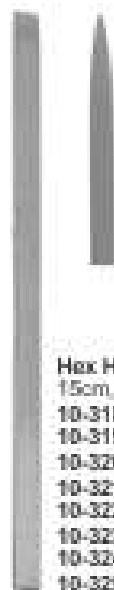
**Mini-Lambotte
Osteotome**
12.5cm
10-297 3mm
10-298 4mm
10-299 6mm
10-300 8mm
10-301 10mm
10-302 12mm
10-303 15mm
Straight



**Mini-Lambotte
Osteotome**
17cm
10-304 3mm
10-305 4mm
10-306 6mm
10-307 8mm
10-308 10mm
10-309 12mm
10-310 15mm
Straight



Lambotte Osteotome
12.5cm, Straight
10-311 2mm tip width
10-312 4mm tip width
10-313 6mm tip width
10-314 8mm tip width
10-315 10mm tip width
10-316 12mm tip width
10-317 15mm tip width



Hex Handle Osteotome
15cm, Straight
10-318 2mm tip width
10-319 3mm tip width
10-320 4mm tip width
10-321 5mm tip width
10-322 6mm tip width
10-323 7mm tip width
10-324 9mm tip width
10-325 10mm tip width



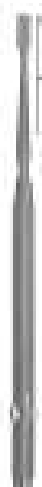
Cottle Osteotome
18.5cm, Straight
10-326 4mm tip width
10-327 6mm tip width
10-328 8mm tip width
10-329 12mm tip width



**Anderson-Niewert
Osteotome**
20.4cm
10-330 Curved right
10-331 Curved left
10-332 Straight



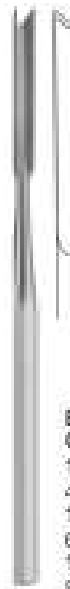
Freer Gouge
10-333 15cm
06mm



Freer Chisel
10-334 16cm
04mm



**Shoulder
Penetrating Gouge**
10-335 21.6cm
Straight, 3mm distal tip



**Ballenger
Chisel** 16cm
10-336
4mm
10-337
6mm
10-338
8mm



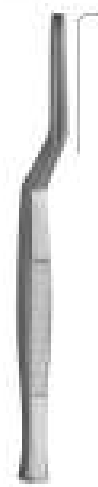
**Mannerfelt
Modif.**



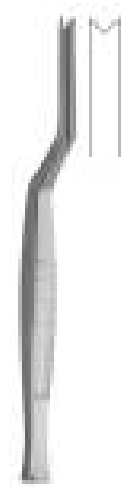
Osteotomes
10-339 4mm
10-340 6mm
10-341 8mm
15.5cm



Gouge
10-342
4mm
15.5cm



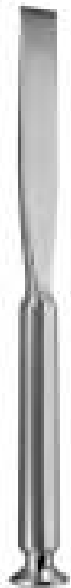
**Killian,
Septum Gouge**
10-343 16cm
5mm



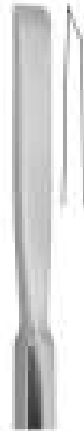
**Killian-Glaus
Septum Gouge**
10-344 16cm
5mm

Knochenmeißel
Ciseaux-burins, gouges

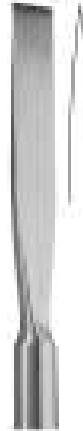
Cineles, gubias
Scalpelli, sgorbi



Stille
20cm



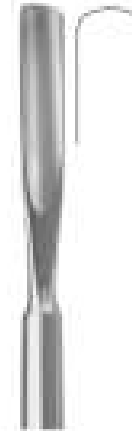
Stille Chisel
10-345 10mm
10-346 15mm
10-347 20mm
10-348 25mm
Straight



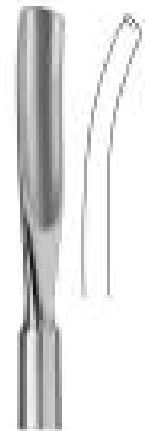
Stille Osteotome
10-349 10mm
10-350 15mm
10-351 20mm
10-352 25mm
Straight



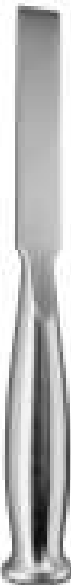
Stille Osteotome
10-353 10mm
10-354 15mm
10-355 20mm
10-356 25mm
Curved



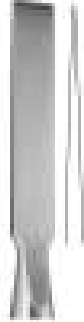
Stille Gouge
10-357 10mm
10-358 15mm
10-359 20mm
10-360 25mm
Straight



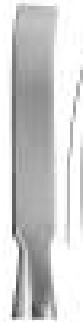
Stille Gouge
10-361 10mm
10-362 15mm
10-363 20mm
10-364 25mm
Curved



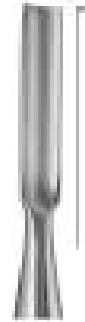
Smith-Petersen
20cm 8"



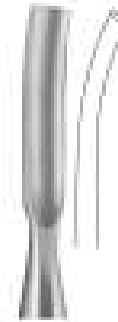
Smith-Petersen osteotome
10-365 8mm
10-366 9mm
10-367 13mm
10-368 16mm
10-369 19mm
10-370 25mm
10-371 32mm
Straight



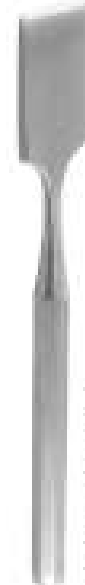
Smith-Petersen Osteotome
10-372 6mm
10-373 9mm
10-374 13mm
10-375 16mm
10-376 19mm
10-377 25mm
10-378 32mm
Curved



Smith-Petersen Gouge
10-379 9mm
10-380 16mm
10-381 19mm
10-382 25mm
Straight



Smith-Petersen Gouge
10-383 9mm
10-384 16mm
10-385 19mm
10-386 25mm
Curved



Hoke Osteotome
14cm
10-387 3mm
10-388 6mm
10-389 7mm
10-390 8.5mm
10-391 10mm
10-392 12mm



Hibbs
24cm



Hibbs Osteotome
10-393 6mm
10-394 13mm
10-395 19mm
10-396 25mm
10-397 32mm
Straight



Hibbs Chisel
10-398 6mm
10-399 13mm
10-400 19mm
10-401 25mm
10-402 32mm
Straight



Hibbs Osteotome
10-403 6mm
10-404 13mm
10-405 19mm
10-406 25mm
10-407 32mm
Curved



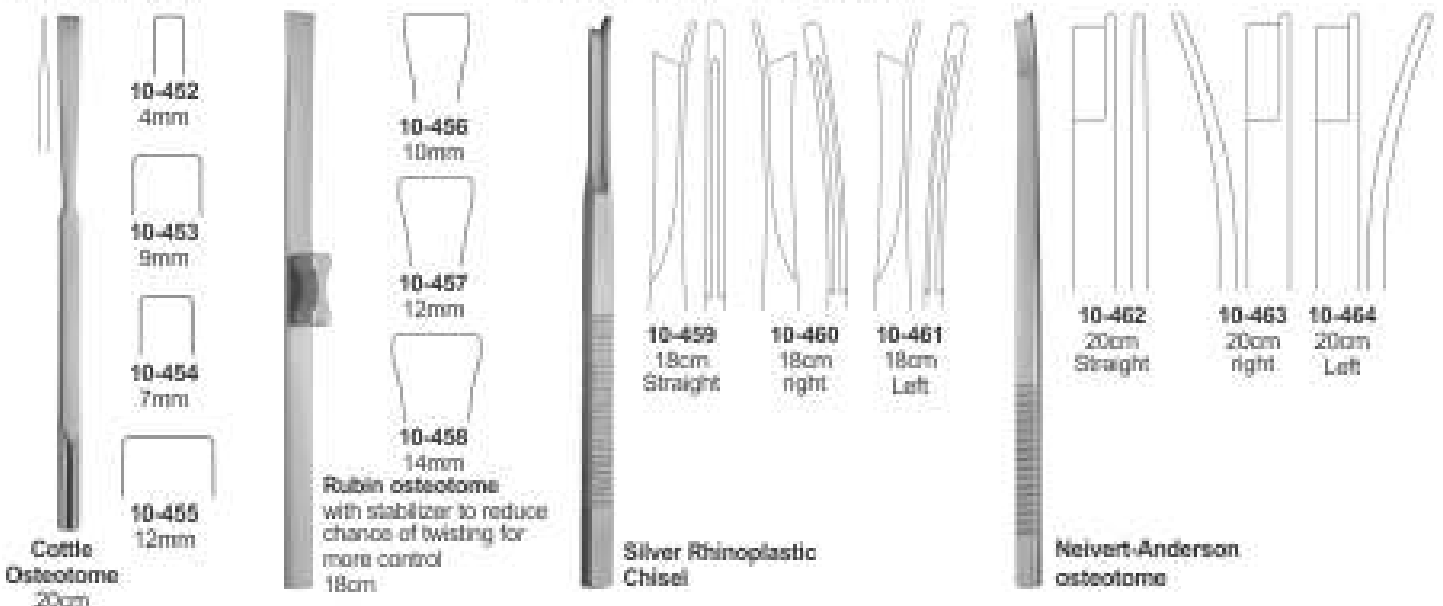
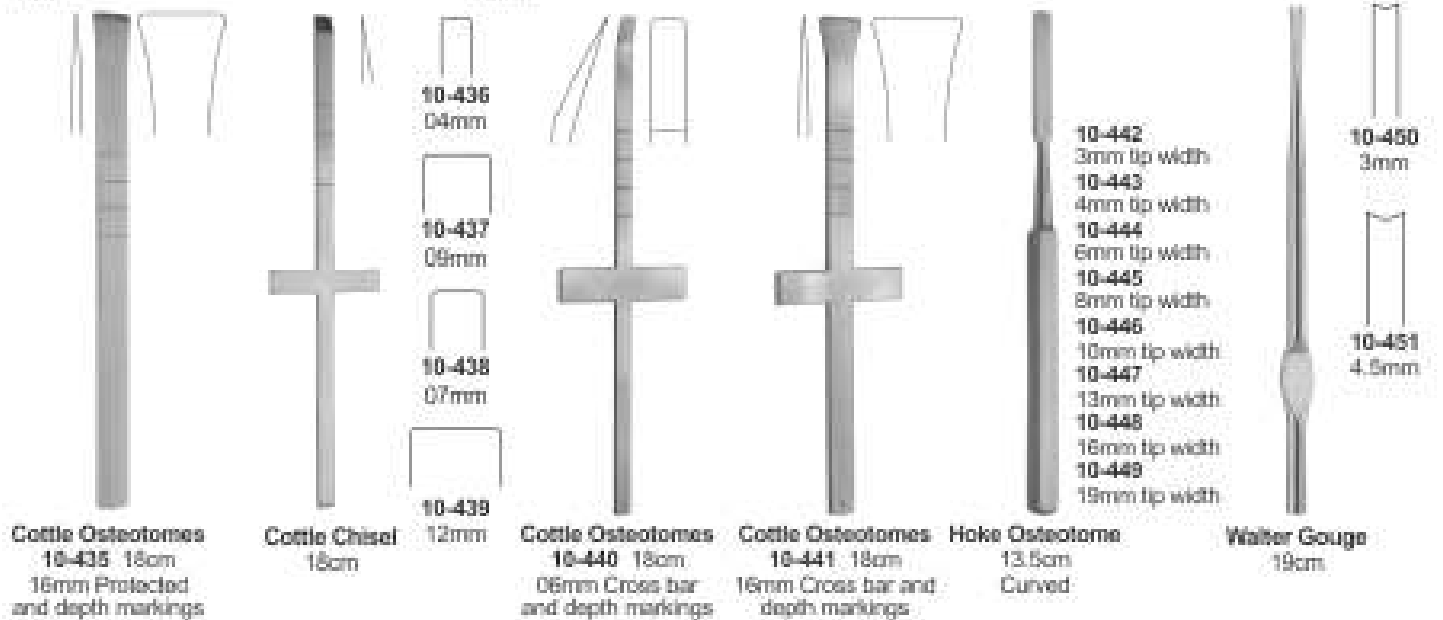
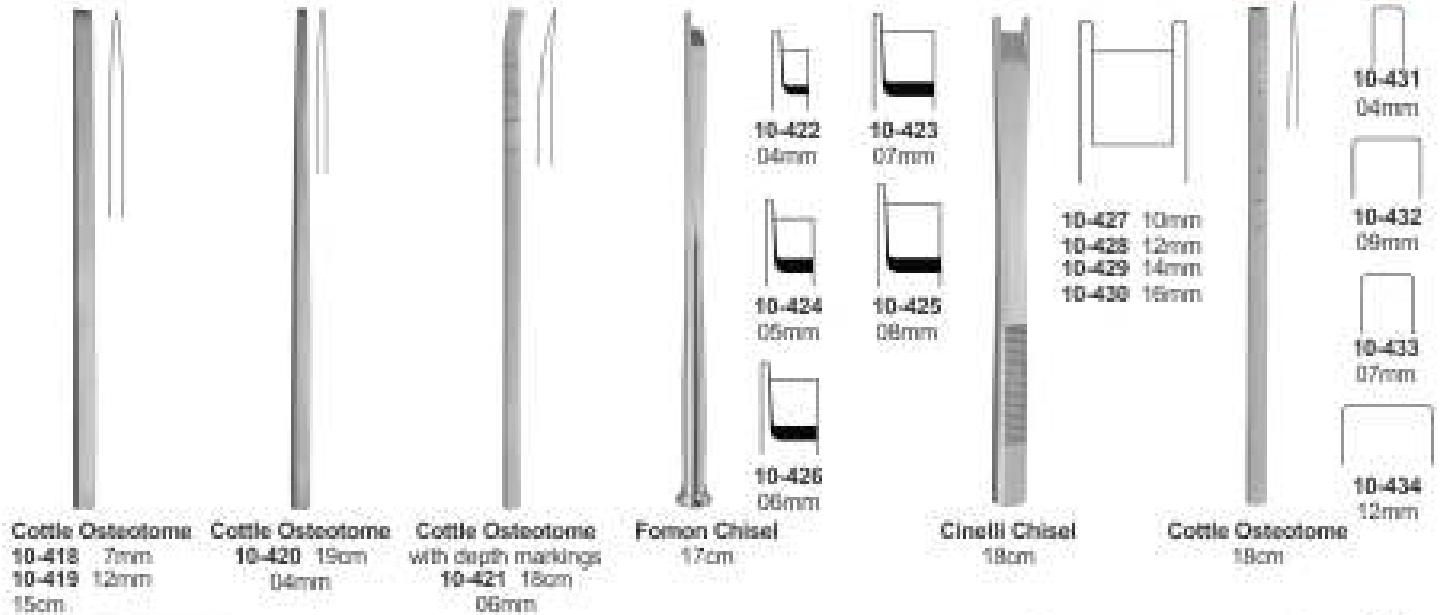
Hibbs Gouge
10-408 6mm
10-409 13mm
10-410 19mm
10-411 25mm
10-412 32mm
Straight



Hibbs Gouge
10-413 6mm
10-414 13mm
10-415 19mm
10-416 25mm
10-417 32mm
Curved

Knochenmeißel
Ciseaux-burins, gouges

Cineles, gubias
Scalpelli, sgorbi

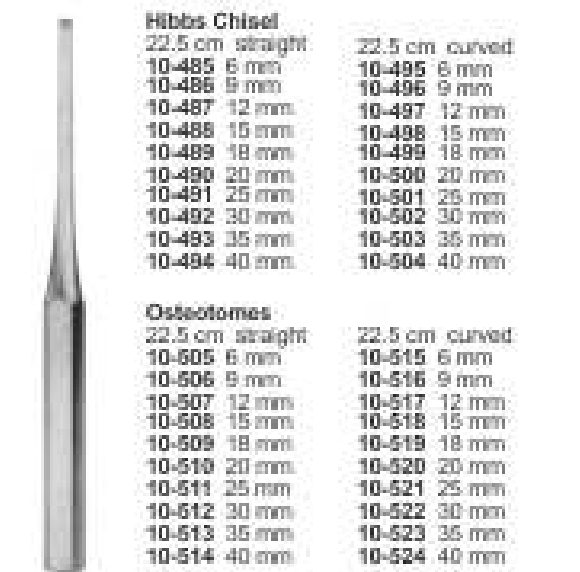
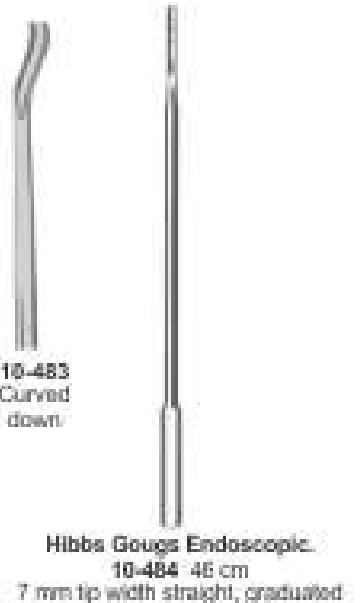
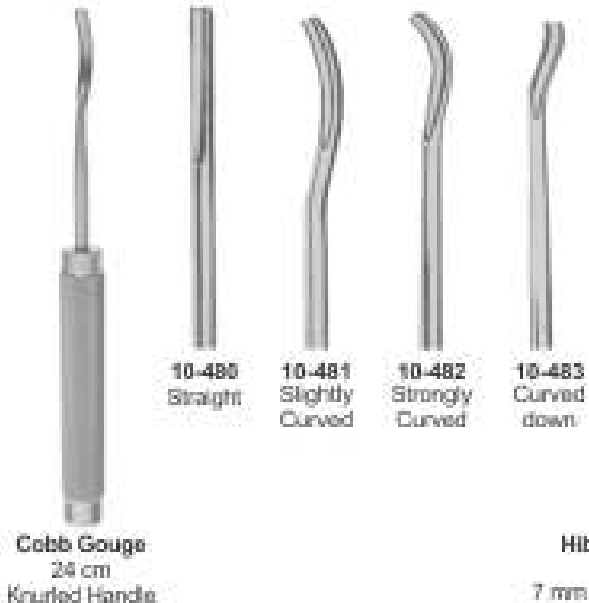
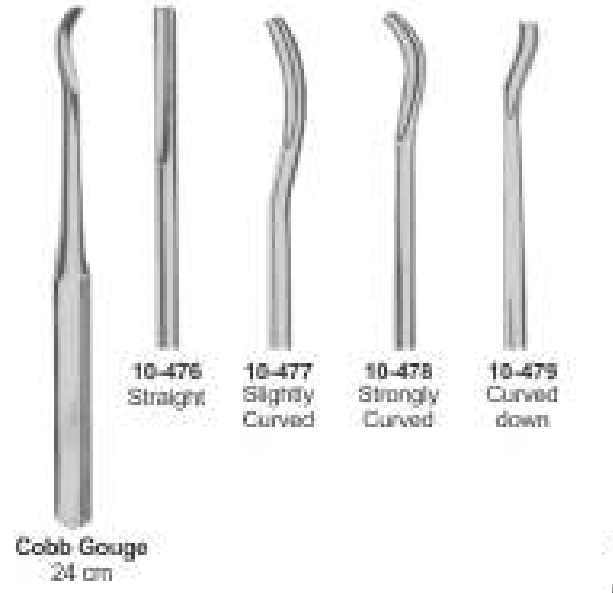
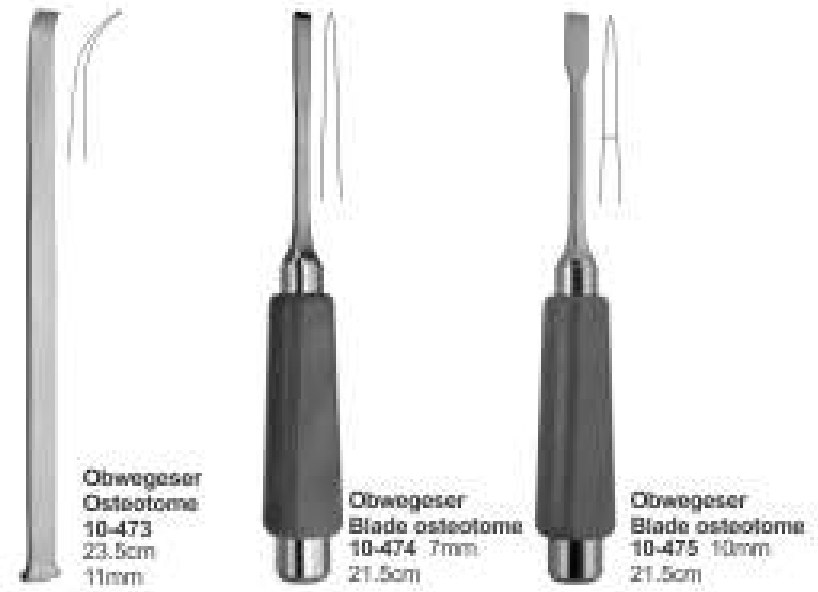
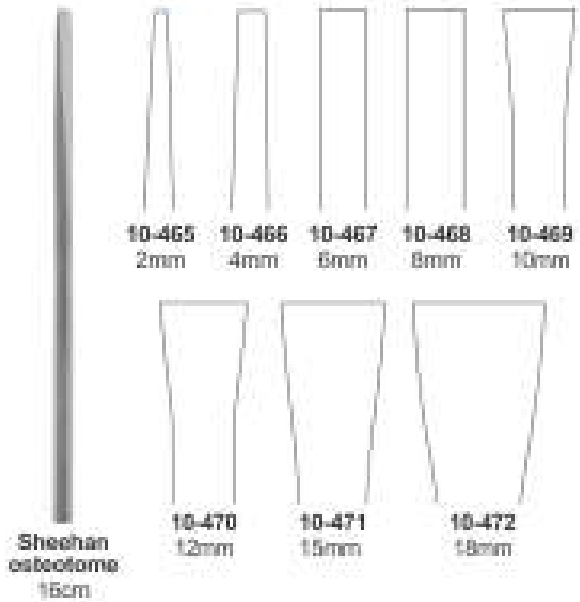


Meißel zur Nasenplastik

Osteotomes, ciseaux-burins pour rhinoplastique

Cinceles para rinoplastica

Scalpell per plastica nasale

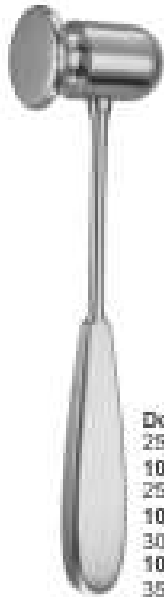


Hibbs Chisel / Osteotomes

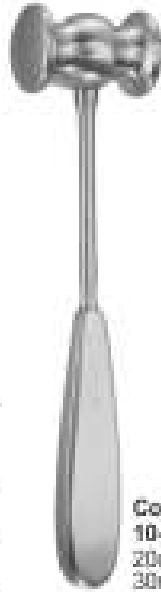
Cobb Chisel / Osteotomes

MALLETS

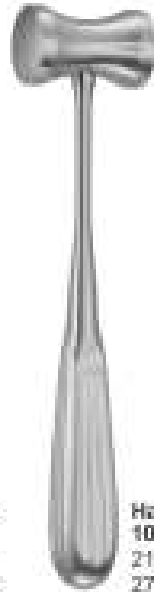
Hammer | Martillos
Mallets | Martelli



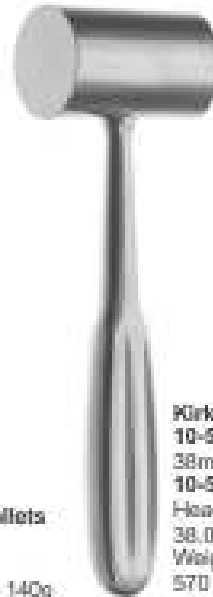
Doyen Mallets
25cm
10-555
25mmØ - 120g
10-556
30mmØ - 180g
10-557
35mmØ - 260g



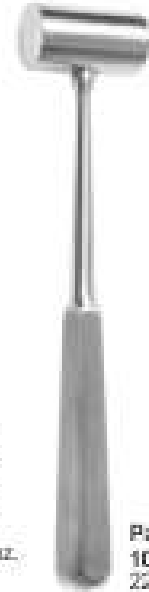
Collin Mallets
10-558
20cm
30mmØ - 220g



Hajek Mallets
10-559
21.5cm
27mmØ - 140g



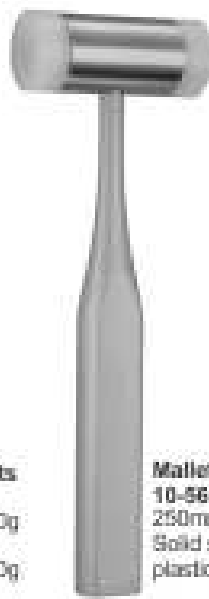
Firk Mallets
10-560 19cm
38mmØ - 750g
10-561 20.4cm
Head diameter
38.0mm,
Weight: 1 lb. 4 oz.
570 grams



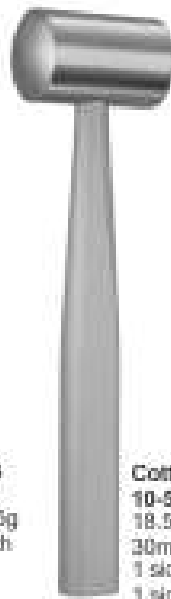
Partsch Mallets
10-562 18cm
22mmØ - 200g



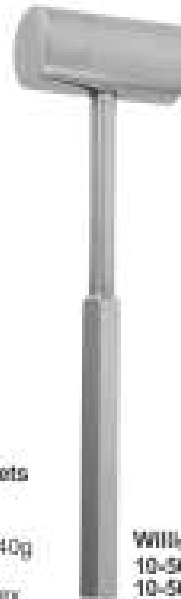
Lucas Mallets
10-563
19mmØ - 220g
10-564
25mmØ - 260g
19cm



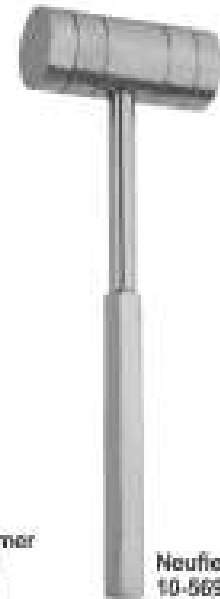
Mallet Mallets
10-565 15cm
250mmØ - 200g
Solid steel, with
plastic faces



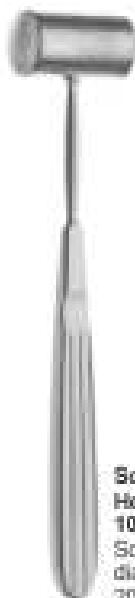
Cottle Mallets
10-566
18.5cm
30mmØ - 240g
1 side flat /
1 side convex



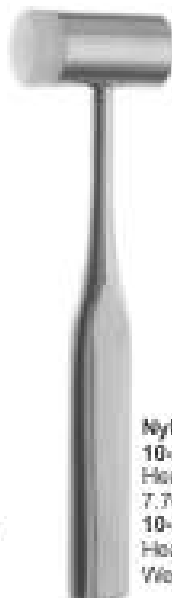
Williger Hammer
10-567 250g
10-568 350g



Neufield Hammer
10-569



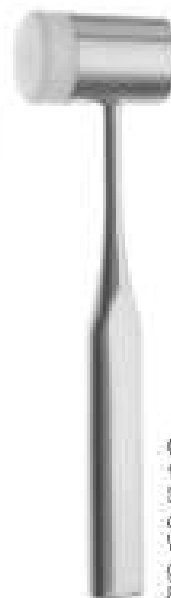
**Solid Copper
Head Mallet**
10-570 16.5cm
Solid, Head
diameter
20mm



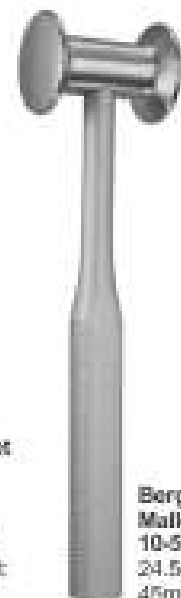
Nylon Head Mallet
10-571 19cm
Head diameter 25.4mm,
7.76 oz.
10-572 19.5cm
Head diameter 3cm
Weight 11 oz.



**Extra 3cm Nylon Face
FOR 10-572**
10-573 - Head diameter
3cm



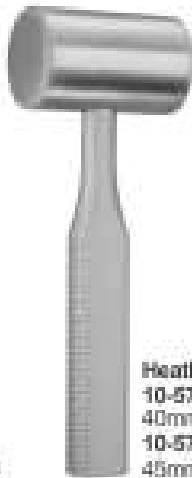
Combination Mallet
10-574 19.5cm
Solid, Head
diameter 32.0mm,
Weight 12 oz 340
grams, Head weight
8 oz 227 grams



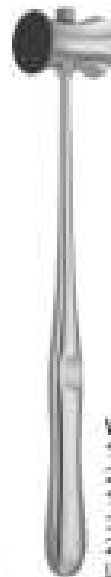
**Bergmann
Mallets**
10-575
24.5cm
45mmØ - 300g



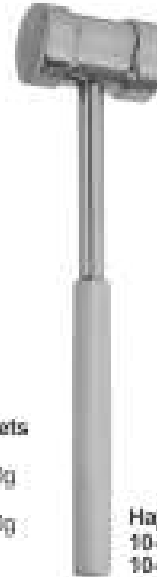
Ombredanne Mallets
10-576
24cm
40mmØ - 550g



Heath Mallets
10-577 18cm
40mmØ - 700g
10-578 20cm
45mmØ - 1000g



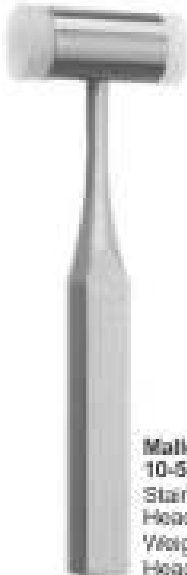
Wittiger Mallets
10-579
28mmØ - 340g
10-580
30mmØ - 400g
24cm
Lead filled



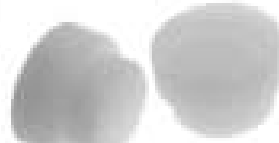
Hajek Hammer
10-581 250gm
10-582 500gm



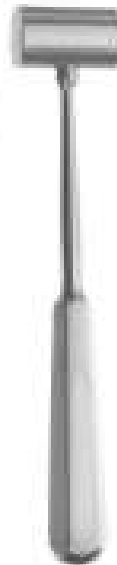
Universal Hammer
10-583 500gm
10-584 750gm



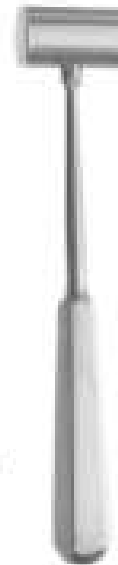
Mallet, Lightweight
10-585 19cm
Stainless Steel and Aluminum
Head diameter 25.0mm
Weight 7 oz 200 grams
Head Weight: 4 oz 113 grams



Nylon Caps Left & Right
FOR 10-585 (PAIR)
10-586
2.5cm



Mallet #49
10-587 19.5cm
Head diameter
22.0mm
Weight 7 oz 200 grams
Head Weight:
5oz/150 grams



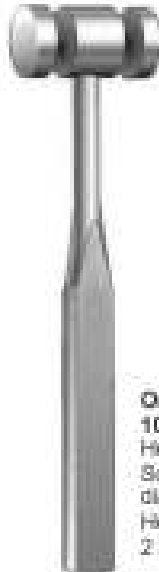
Head Mallet
10-588 19cm
Head diameter
26.0mm
Weight 11 oz 315 grams
Head Weight:
6 oz 170 grams



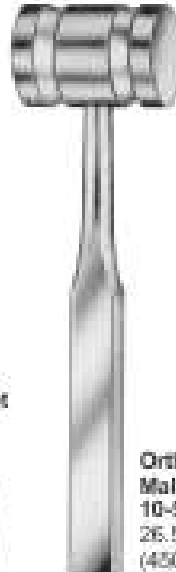
Heath Mallet, Heavyweight
10-589 19cm
Head diameter
40.0mm
Weight 2 lbs.
(907 grams)
Head Weight:
20 oz (567 grams)



Orthopedic Mallet
10-590 27.5cm
Lightweight
Solid, Head
diameter 35.0mm
Weight 2 lbs.
(907 grams)
Head Weight:
1 lb. (454 grams)



Orthopedic Mallet
10-591 28cm
Heavyweight
Solid, Head
diameter 50.0mm
Head Weight:
2 lb. (900 grams)



Ortho Mallets
10-592
26.5cm
(450g)

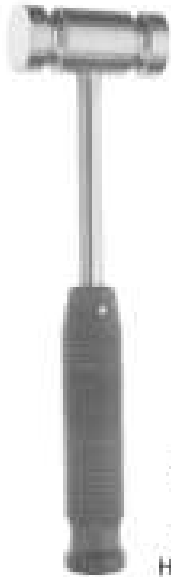


Nylon Cap
10-593
For Phenolic Handle Mallet

Phenolic Handle Mallet
10-593 28 cm
Head diameter 32mm
Head weight 16 oz (454 grams)
10-594 Head diameter 45mm
Weight 11 oz (312 grams);
Head weight: 2 lbs (907 grams),

MALLETS

Hammer | Martillos
Mallets | Martelli



Reproclusion Free Mallet
Cap For 10-596

Reproclusion Free Mallet
10-595 28cm
Head diameter 30mm
Weight 1lb 5.oz (595 grams)
Head weight: 10 oz (283 grams)



Mallet
10-597 26cm
Plane (Nylon)
convex (steel)
Head 30mm Ø
weight 675 grams.



Mallet
10-598 26cm
Head 42/30mm Ø
weight 530 grams



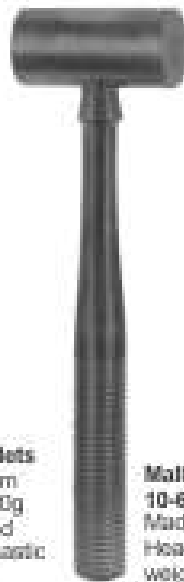
Mallet
10-599 26cm
Plastic Handle
head 30mm Ø
weight 510 grams



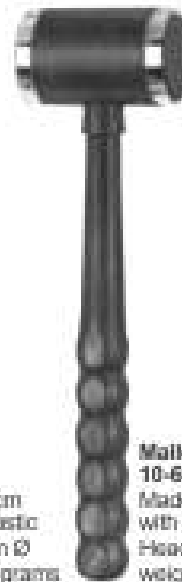
Vickers Mallets
10-600 19 cm
25mmØ - 300g
nylon disks plastic



Herbert Mallets
10-601 19 cm
25mmØ - 300g
for ulnar head
prosthesis plastic
handle



Mallet
10-602 18cm
Made of Plastic
Head 30mm Ø
weight 125 grams



Mallet
10-603 26 cm
Made of Plastic
with lead filling
Head 42mm Ø
weight 250 grams

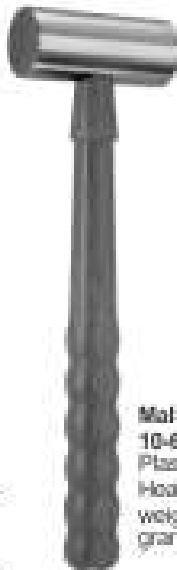


Spare Facings (pair)
10-605 Plastic

Mallet
10-604 22.5 cm
Disks & Plastic Handle
Head 37mm Ø
weight 370 grams



Mallet
26 cm
Made of Plastic
with lead filling
10-606
Head 42 mm Ø
weight 400 grams
10-607
Head 42 mm Ø
weight 250 grams



Mallet
10-608 24cm
Plastic Handle
Head 30mm Ø
weight 490
grams



Mallet
10-609



Mallet
10-610



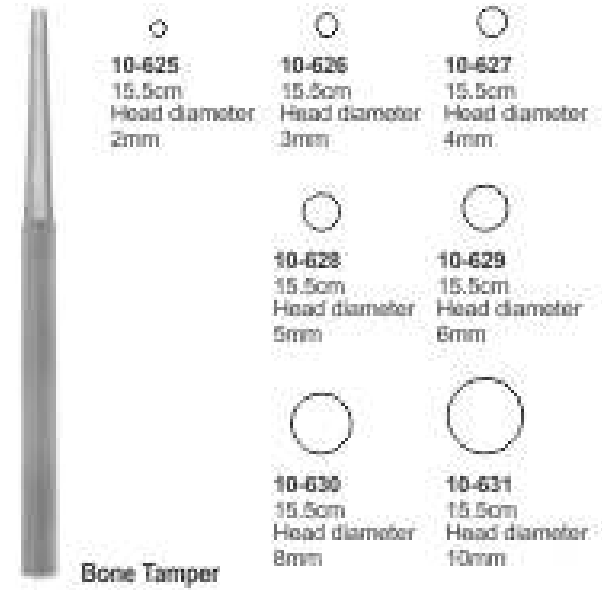
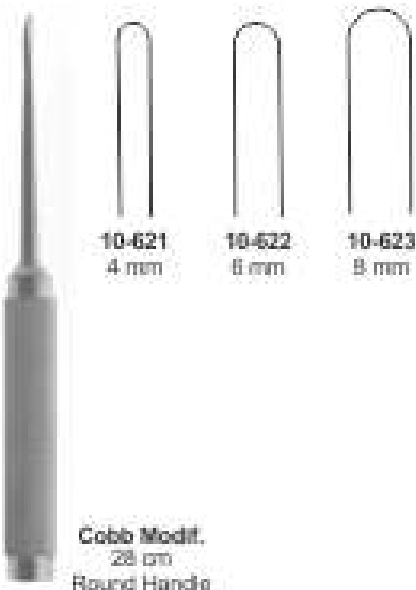
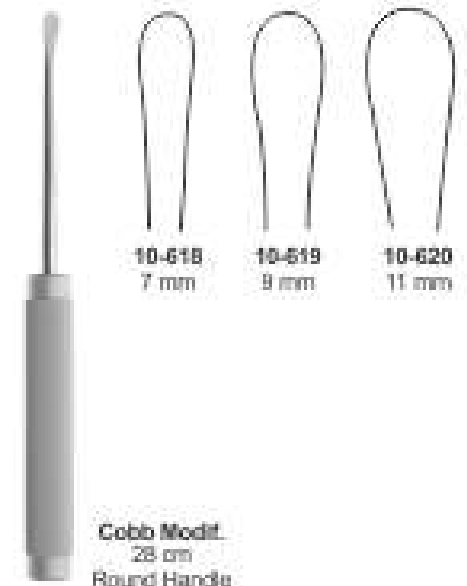
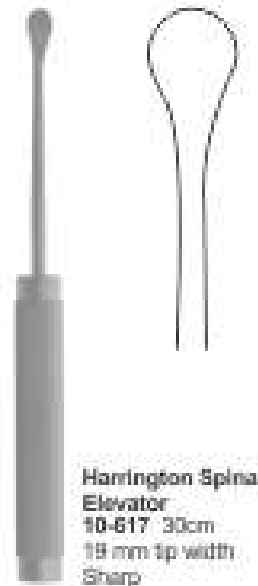
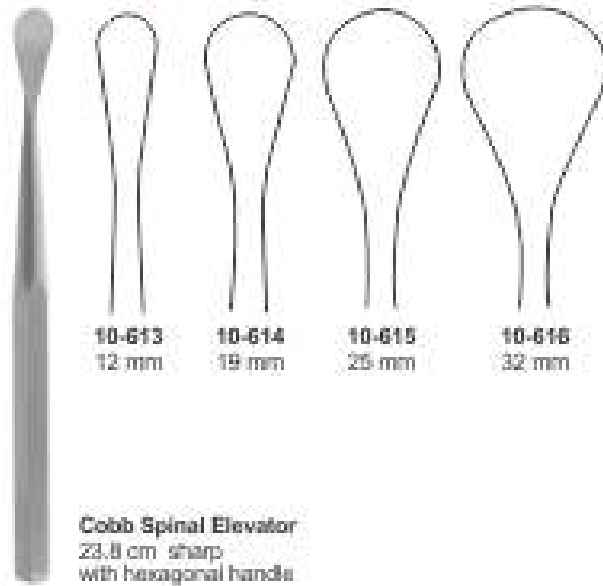
Mallet
10-611



Mallet
10-612

Raspatorien, Stöbel
Periostotomos, Pions

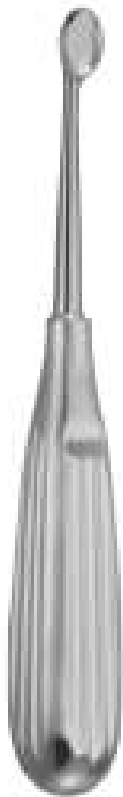
Rugines-raspatoires, Punzones
Periostotomi, Pistoni



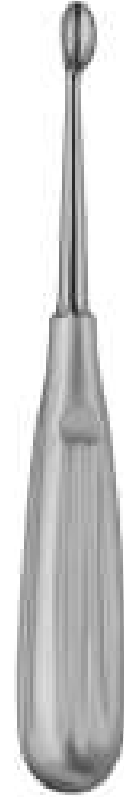
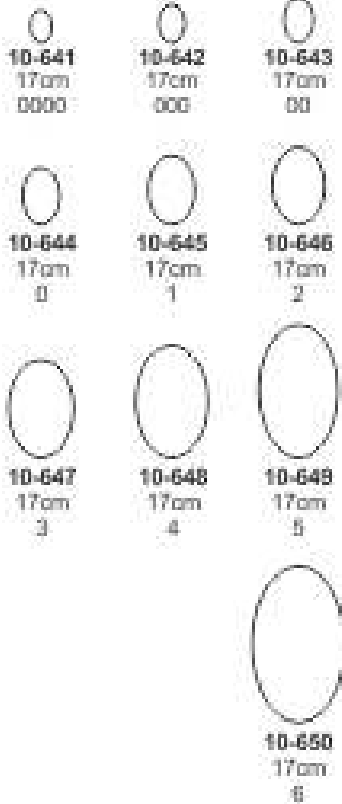
BONE CURETTES

Scharfe Löffel
Curettes tranchantes

cucharillas cortantes
Cucchiai taglienti



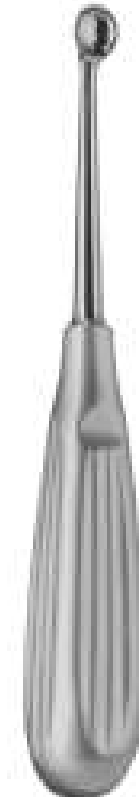
Volkmann Bone Curette



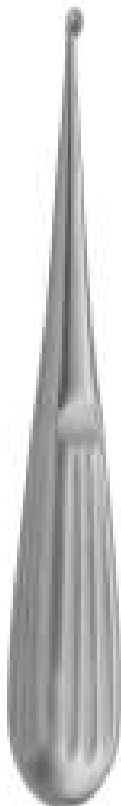
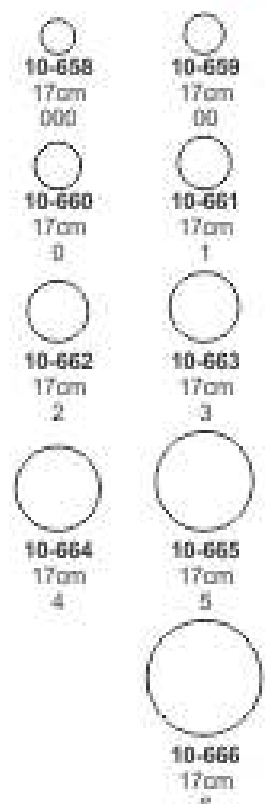
Schede Bone Curette
17cm



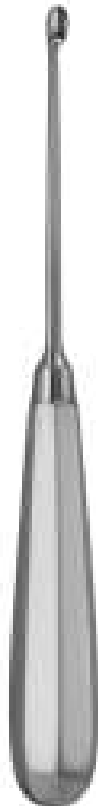
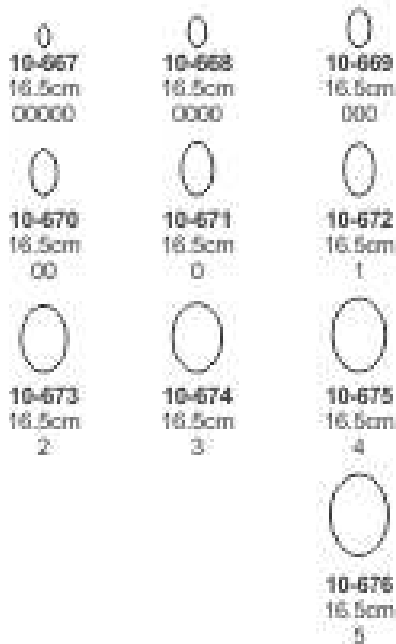
10-657
17cm
4



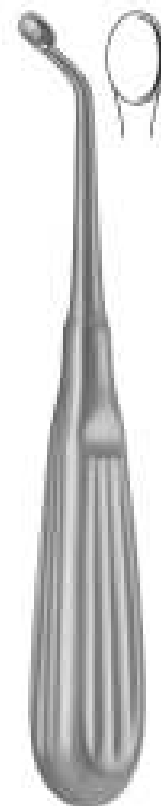
Bruns Bone Curette



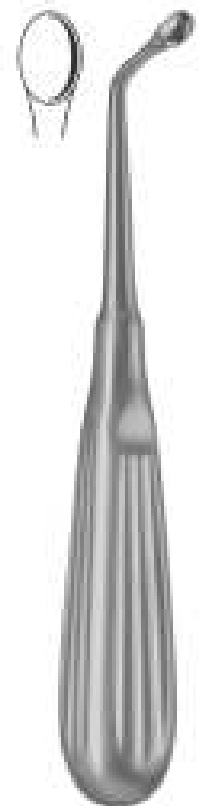
Spratt Bone Curette / Hollow Handle



Halle Bone Curette Flexible



Uffenorde Bone Curette Left
10-680 17.5cm

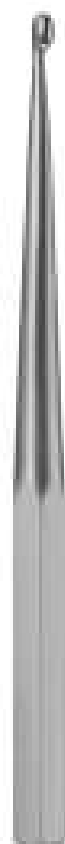


Uffenorde Bone Curette Right
10-681 17.5cm

BONE CURETTES

Scharfe Löffel
Curettes tranchantes

cucharillas cortantes
Cucchiai taglienti



Bruns Bone Curette
23 cm

Fig.1
10-682

Fig.3
10-684

Fig.5
10-686

Fig.7
10-688

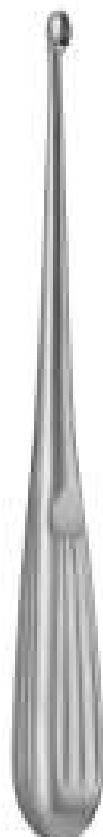
Fig.2
10-683

Fig.4
10-685

Fig.6
10-687

Fig.8
10-689

Fig.9
10-690



Bone Curette
Straight

10-691
20cm
000

10-693
20cm
0

10-695
20cm
2

10-697
20cm
4

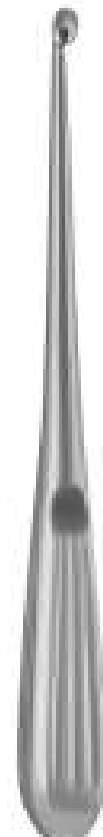
10-692
20cm
00

10-694
20cm
1

10-696
20cm
3

10-698
20cm
5

10-699
20cm
6



Bone Curette
Curved

10-700
20cm
000

10-702
20cm
0

10-704
20cm
2

10-706
20cm
4

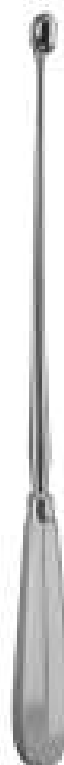
10-701
20cm
00

10-703
20cm
1

10-705
20cm
3

10-707
20cm
5

10-708
20cm
6



Schroeder Bone Curette
Sharp / right

10-709
30cm
1

10-711
30cm
3

10-713
30cm
5

10-710
30cm
2

10-712
30cm
4

10-714
30cm
6



Simon Bone Curette
Sharp / right

10-715
24cm
0000

10-719
25cm
1

10-722
25cm
4

10-716
24cm
000

10-720
25cm
2

10-723
25cm
5

10-717
24cm
00

10-721
25cm
3

10-724
25cm
6

10-718
24cm
0

BONE CURETTES



Scharfe Löffel

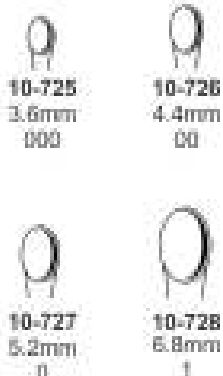
cucharillas cortantes

Curettes tranchantes

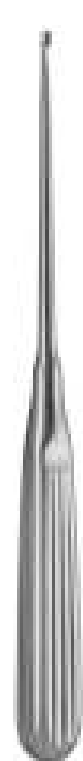
Cucchiai taglienti



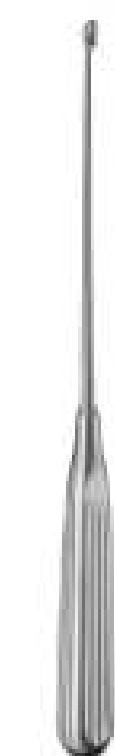
Bone Curette
25 cm
Straight



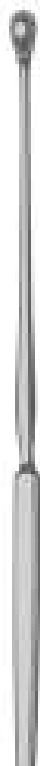
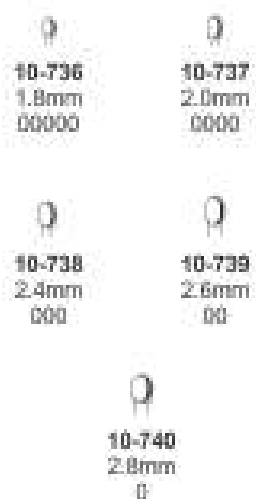
Daubenspeck Bone Curette
20 cm



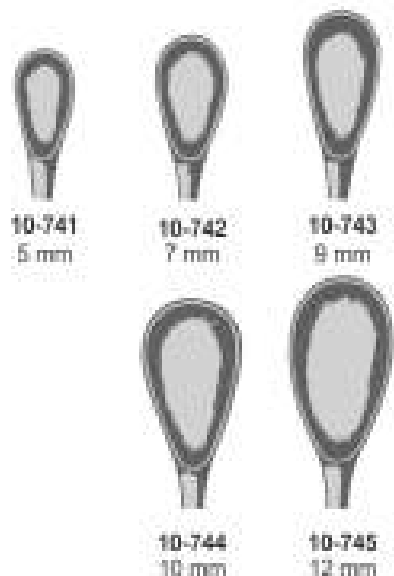
Scoville Bone Curette
25 cm



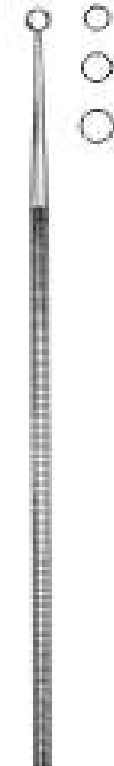
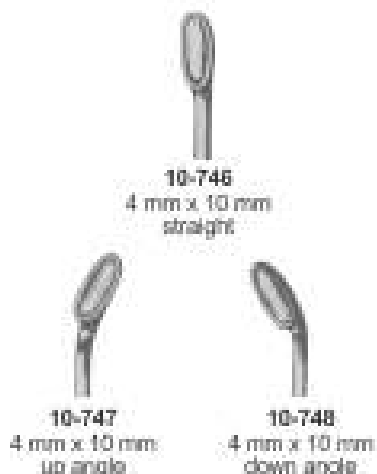
Lempert Bone Curette
21.5 cm



Cushing Bone Curette
23.5 cm
Pituitary Spoon,
malleable, silver-plated



Scoville Bone Curette
25 cm
Ruptured Disc Curette



Tay-Bronson Bone Curette
22 cm
Pituitary Curette, double-edged



BONE CURETTES

Scharfe Löffel

cuchariñas cortantes

Curettes tranchantes

Cucchiai taglienti



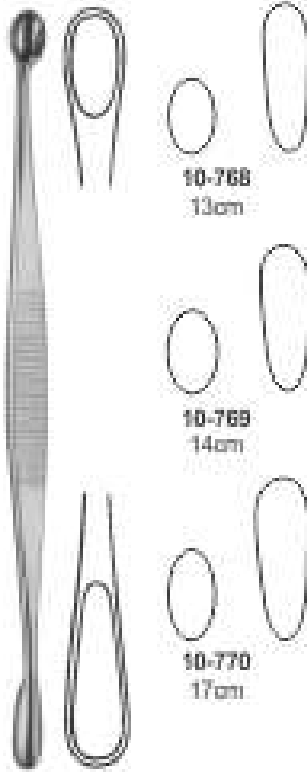
Ray Bone Curette, 19 cm
Pituitary Curette

45°
10-756 Ø 3 mm
10-757 Ø 4 mm
10-758 Ø 5 mm

90°
10-759 Ø 3 mm
10-760 Ø 4 mm
10-761 Ø 5 mm

45° offset
10-762 Ø 3 mm
10-763 Ø 4 mm
10-764 Ø 5 mm

90° offset
10-765 Ø 3 mm
10-766 Ø 4 mm
10-767 Ø 5 mm

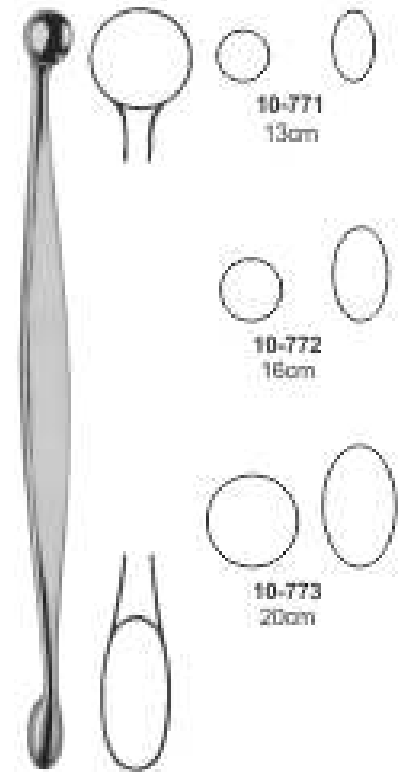


Volkmann
Curette
Oval / Oval

10-768
13cm

10-769
14cm

10-770
17cm

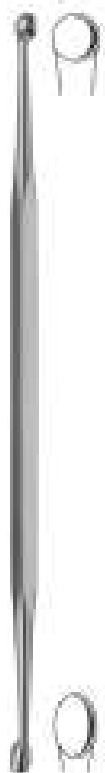


Volkmann
Curette
Round / Oval

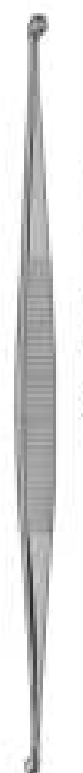
10-771
13cm

10-772
15cm

10-773
20cm



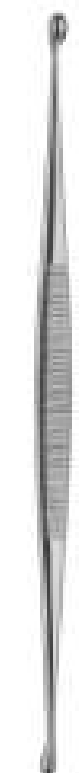
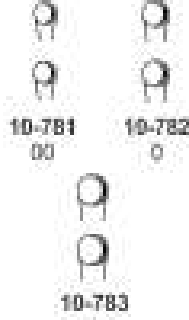
Curette
10-774
21cm
round / oval



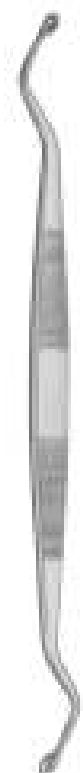
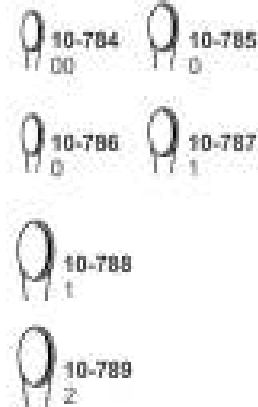
Martini
Curette
13.5cm



Martini
Curette
15.5cm



Williger
Curette
13.5cm



Williger
Curette
15.5cm



BONE CURETTES

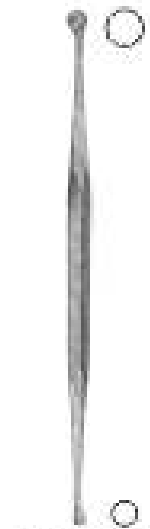


Scharfe Löffel

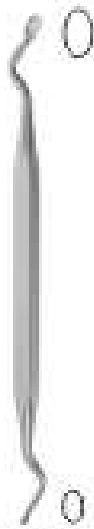
Curettes tranchantes

cucharillas cortantes

Cucchiai taglienti



Jansen Curette
10-793 16cm



Jansen Curette
10-794 15cm



Williger Curette
10-795 13.25cm
Double Ended 00/0



Curette

10-796 13cm
Double Ended
6.2 mm & 6.7 mm

10-797 15cm
Double Ended
7 mm & 9 mm

10-798 20cm
Double Ended
9.1 mm & 11.1 mm

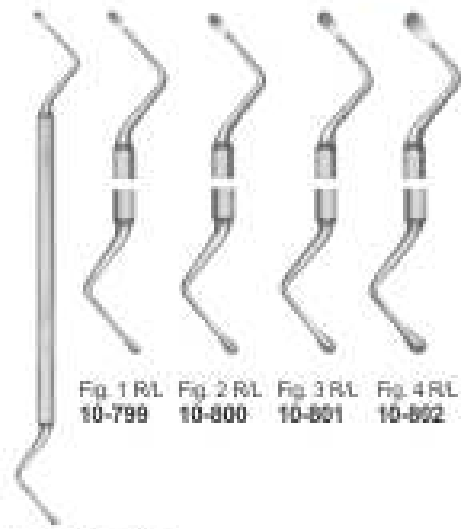
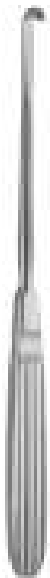


Fig. 1 RL 10-799
Fig. 2 RL 10-800
Fig. 3 RL 10-801
Fig. 4 RL 10-802

Lucas Curette
double-ended
18cm

PERIOSTEAL ELEVATORS



Obwegeser
Elevator



10-803
17cm
6 mm



10-804
17cm
7 mm



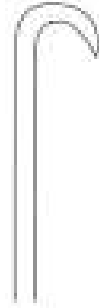
10-805
17cm
9 mm



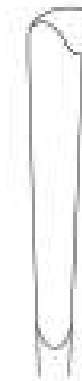
10-806
17cm
11 mm



10-807
20cm
5 mm



10-808
20cm
8 mm



10-809
20cm
9 mm



Obwegeser-
Freer
Elevator
10-810 21cm



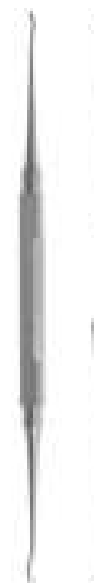
Obwegeser-
Freer
Elevator
10-811
21cm



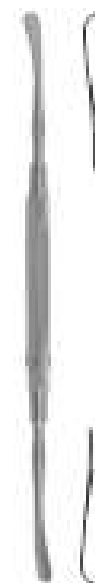
Sachs Nerve
elevator
10-812
18.5cm
3 mm blunt



Kleinert Kutz
Elevator and
Dissector
10-813
18.5cm
2 mm x 3 mm
Sharp ends



Freer Elevator
10-814 18.5cm
double-ended
5 mm sharp end
5 mm blunt end



PERIOSTEAL ELEVATORS

Raspatorien

Rugines-raspatoires

Periostotomas

Periostotomi



Woodson Elevator/ Spatula
10-815
22.5cm
double ended
3 mm semi-blunt ends



Woodson Dural Separator/Packer
10-816 17.5cm
double ended with
grooved
Blade 3 mm blunt
end



Penfield Elevators
10-817
style #1
17.5 cm
double ended



Penfield Elevators
10-818
style #2
18.5 cm
double ended



Penfield Elevators
10-819
style #3
28 cm
double ended



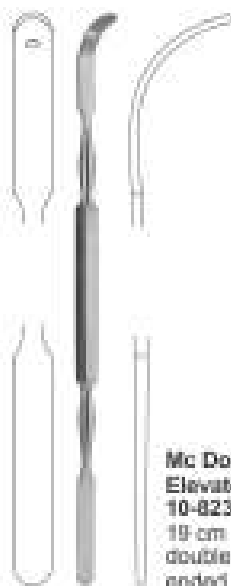
Penfield Elevators
10-820
style #4
28 cm
single ended



Penfield Elevators
10-821
style #5
18.5 cm
double ended



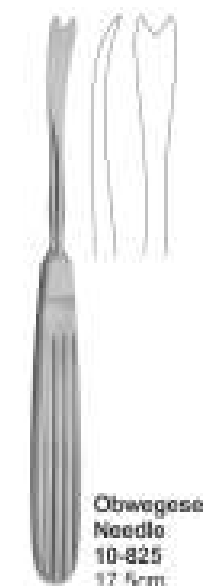
Alderdyce Elevators
10-822
21.5 cm
double ended



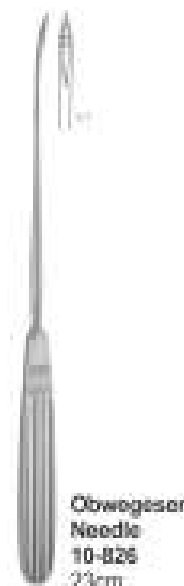
Mc Donald Elevators
10-823
19 cm
double ended



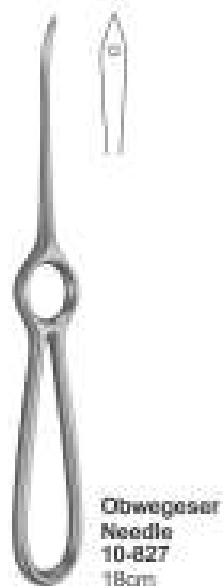
Watson-Cheyne Elevators
10-824
19 cm
double ended



Obwegeser Needle
10-825
17.5cm



Obwegeser Needle
10-826
23cm



Obwegeser Needle
10-827
18cm



Obwegeser Needle
10-828
14cm



Doyen Rib Raspatory
17cm



Doyen Rib Raspatory
17cm



Sedillot Elevator
10-833
18.5cm
10-834
21cm

10-829
Right Crved
For Adults

10-830
Right Crved
For Children

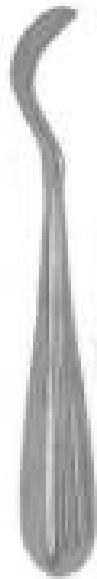
10-831
Left Crved
For Adults

10-832
Left Crved
For Children

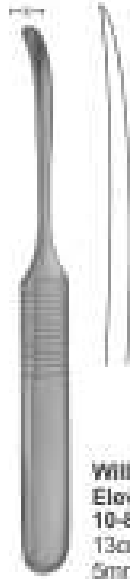
PERIOSTEAL ELEVATORS



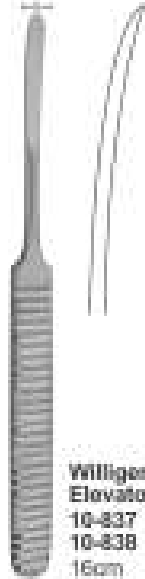
Raspatorien | Rujines-raspatoires
 Periostatomos | Periostatomi



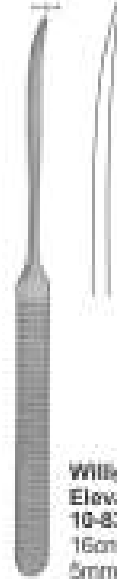
Crego Periosteal Elevator
 10-835
 15.5cm



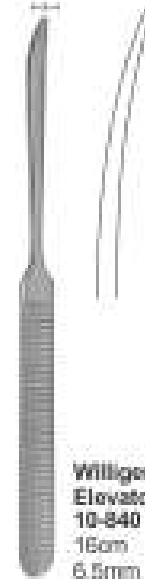
Williger Elevator
 10-836
 13cm
 5mm



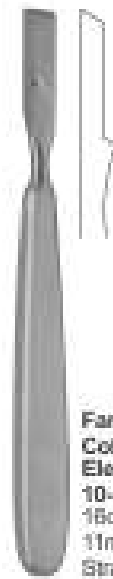
Williger Elevator
 10-837 4mm
 10-838 6mm
 16cm



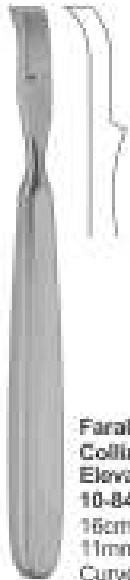
Williger Elevator
 10-839
 16cm
 5mm



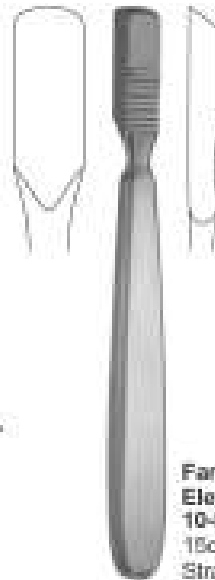
Williger Elevator
 10-840
 16cm
 6.5mm



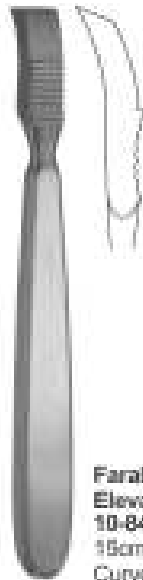
Farabeuf-Collin Elevator
 10-841
 16cm
 11mm
 Straight



Farabeuf-Collin Elevator
 10-842
 16cm
 11mm
 Curved



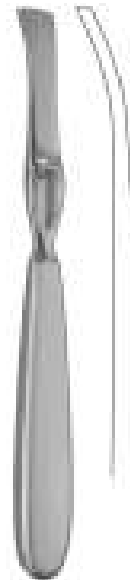
Farabeuf Elevator
 10-843
 15cm
 Straight



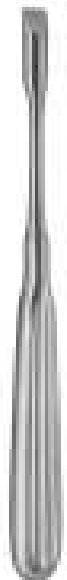
Farabeuf Elevator
 10-844
 15cm
 Curved



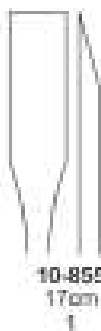
Lambotte Elevator
 10-845 5mm
 10-846 10mm
 10-847 15mm
 10-848 20mm
 10-849 25mm
 21cm Straight



Lambotte Elevator
 10-850 5mm
 10-851 10mm
 10-852 15mm
 10-853 20mm
 10-854 25mm
 21cm Curved



Adson Elevator



10-855
 17cm
 1



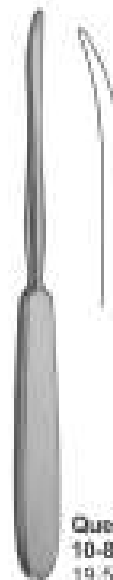
10-856
 17cm
 2



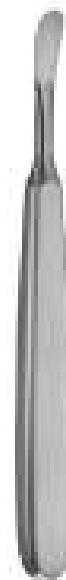
10-857
 17cm
 3



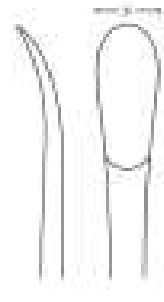
10-858
 17cm
 4



Quervain Elevator
 10-859 06mm
 19.5cm

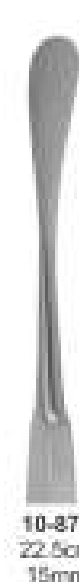
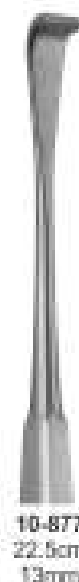
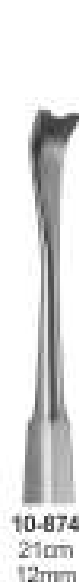
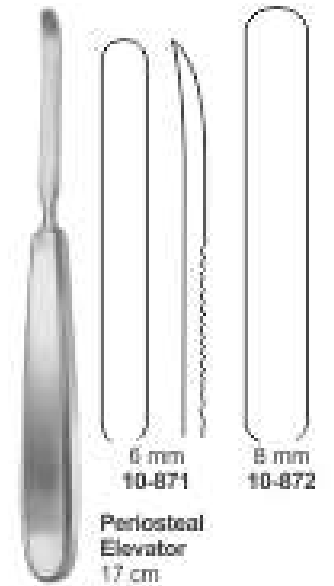
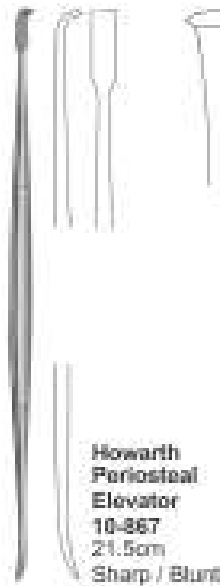
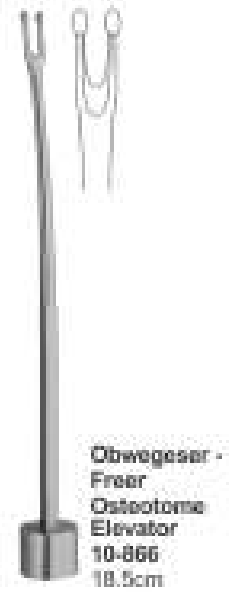
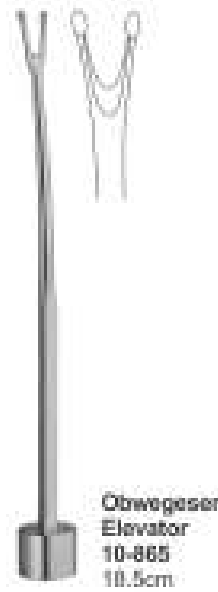
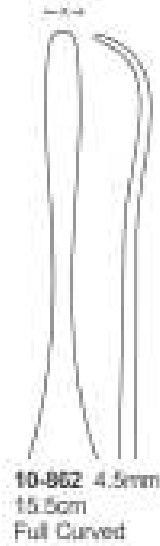
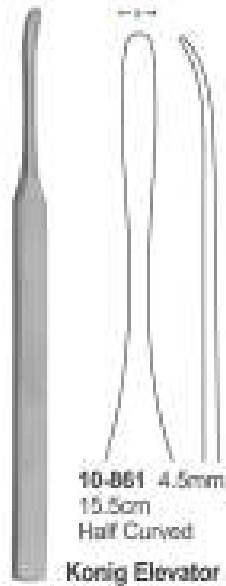


Trelat Elevator
 10-860 8mm
 16cm



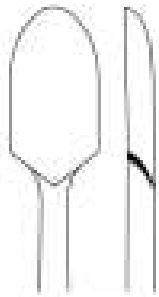
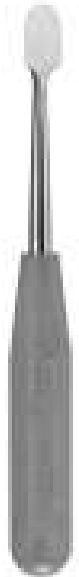
PERIOSTEAL ELEVATORS

Raspatorien | Rugines-raspatoires
 Periostotomas | Periostatomi

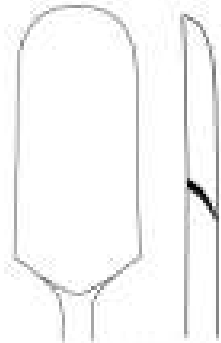


PERIOSTEAL ELEVATORS

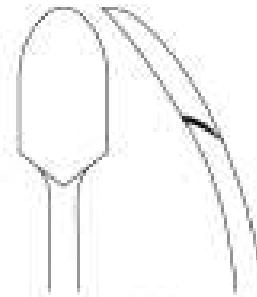
Raspatorien | Rugines-raspatoires
 Periostatomes | Periostatomi



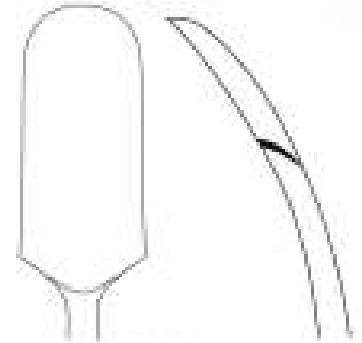
10-879
14mm
Straight
1



10-880
20mm
Straight
3

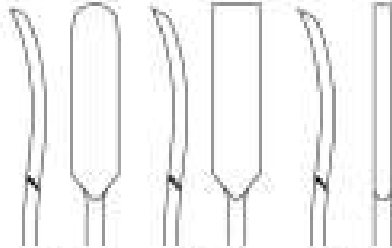


10-881
14mm
Curved
2



10-882
20mm
Curved
3

Ferrozell Periosteal Elevator
20cm



10-883
6mm
1

10-884
3mm
2

10-885
6mm
3

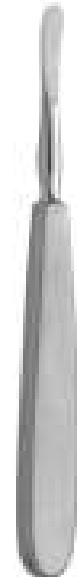
Ferrozell Periosteal Elevator
18cm



Periosteal
Raspatories
10-886
18.5cm
c/d



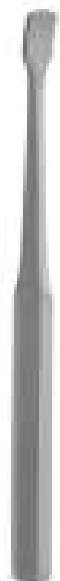
Periosteal Elevator
10-887 18cm
Fiber/Phenolic Handle
blade 6mm



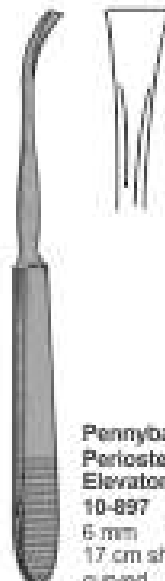
Hoen
Periosteal
Elevator
10-888
16.5cm



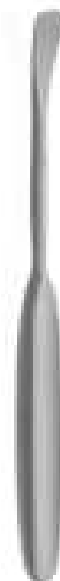
Chandler Bone
Elevator
10-889 19cm
13 mm
10-890 20cm
20 mm
10-891 23cm
25 mm
10-892 25cm
31 mm



Key Periosteal
Elevator 19cm
10-893
6 mm
10-894
12 mm
10-895
20 mm
10-896
25 mm
sharp,
slightly
curved



Pennybacker
Periosteal
Elevator
10-897
6 mm
17 cm sharp,
curved



Langenbeck
Periosteal
Elevator
10-898
16 mm
19 cm
sharp, slightly
curved



Cushing
Periosteal
Elevator 15 mm
10-899
Round Edge
10-900
Square Edge
18 cm

PERIOSTEAL ELEVATORS

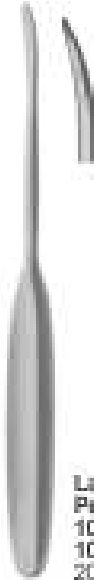
Raspatorien | Rugines-raspatoires
 Periostotomas | Periostatomi



Heen Periosteal Elevator
 10-901
 7mm, 16cm
 10-902
 15mm, 19cm
 10-903
 20mm, 19cm
 Semisharp



Sayre Periosteal Elevator
 10-904 17cm
 one straight blunt
 and one curved
 sharp



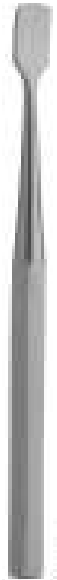
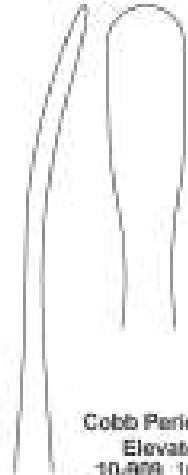
Langenbeck Periosteal Elevator
 10-905 7mm
 10-906 10mm
 20 cm Blunt



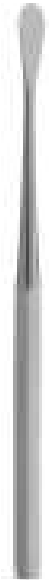
Cushing Periosteal Elevator
 19cm
 10-907
 Left
 10-908
 Right



Cobb Periosteal Elevator
 10-909 10mm
 10-910 13mm
 10-911 19mm
 29cm
 Spinal Raspatory



Key Periosteal Elevator



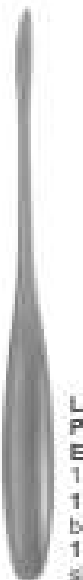
Cobb Periosteal Elevator
 10-917 23.4cm
 Hex Handle



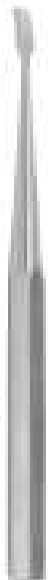
Darrach Elevator
 10-918 26cm
 19mm
 10-919 35cm
 26.4mm
 Blunt, Slightly
 Curved



Carroll Periosteal Elevator
 10-920 14cm
 sharp, double ended
 3 mm round end,
 10 mm flat end



Langenbeck Periosteal Elevator
 19.5cm
 10-921
 blunt edge
 10-922
 sharp edge



Key Periosteal Elevator sharp edge
 10-923 17.7 cm 6.5 mm width
 10-924 18.5 cm 9.5 mm width
 10-925 18.5 cm 12.7 mm width
 10-926 20.0 cm 19.0 mm width
 10-927 20.9 cm 25.0 mm width



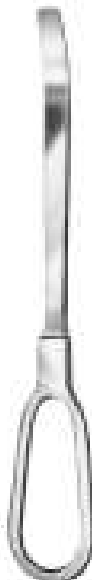
Lane Bone Elevator
 10-928
 16cm
 Serrated



Lane Bone Elevator
 10-929
 27cm



Trethowan's Bone Elevator
 10-930
 22cm



Bristow's Bone Lever
 10-931
 24cm

PERIOSTEAL ELEVATORS, MENISCOTOMY KNIVES

Raspatorien, Meniskotome

Rugines-raspatoires, Bisturies para meniscos

Periostotomas, Bistouries a menisques

Periostotomi, Bisturi per menisco



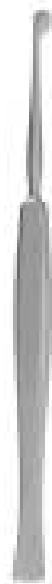
St. Thomas
10-932
16cm
Pointed



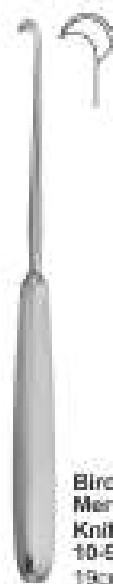
St. Thomas
10-933
16cm
Rounded



Robinson's
10-934
17cm



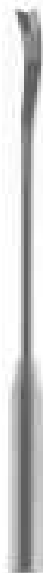
Freer D
Septum
Knife
10-935
15cm



Bircher
Meniscotomy
Knife
10-936
19cm



Matson
Meniscotomy
Knife
10-937
22cm



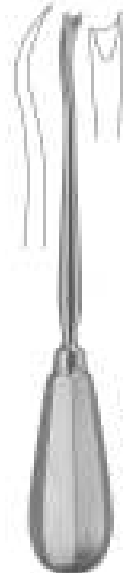
Downing
Cartilage
Knife
10-938
25.5cm
Curved tip,
Straight shaft.



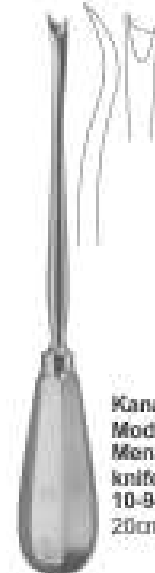
Smillie
Meniscotomy
Knife
10-939 16cm
Straight Shaft
Blade tip width
is 7.8mm
Straight tip



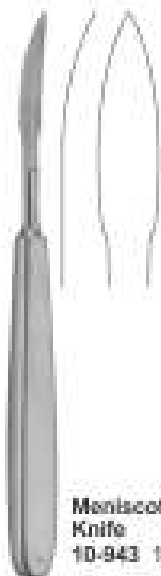
Smillie
Meniscotomy
Knife
10-940 16cm
Curved Shaft
Blade tip width
is 7.8mm
Curved left tip



Kanadisches
Modell
Meniscotomy
knife
10-941
20cm



Kanadisches
Modell
Meniscotomy
knife
10-942
20cm



Meniscotomy
Knife
10-943 18cm



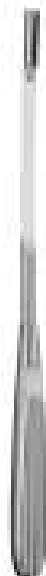
Neff Meniscotomy
Knife



10-944
22cm
left



10-945
22cm
right



Bunnell Tendon
Strippers
23cm
Malleable shaft



10-946
4mm



10-947
4.5mm



10-948
5.5mm



Bunnell
Tendon
Strippers
15.2cm



10-949
Fig. 1
3mm



10-951
Fig. 3
5mm



10-950
Fig. 2
4mm



10-962
Fig. 4
6mm



10-953
Fig. 5
7mm



Fischer
Tendon
Strippers
10-954
31cm

Sehnenstripper, Knochenhebel

enucleadores de tendones, Elevadores para huesos

Instruments a écarcher les tendons, Leviers a os

Scollatendini, Elevatori per ossa



Bunnell Tendon Strippers
10-955 23cm
Tendon passer



Kleinert-Kutz Tendon Retrivers
10-956 20cm
Serrated



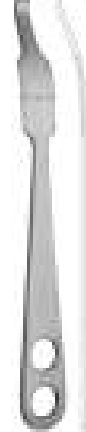
Kleinert-Kutz Tendon Retrivers
10-957 20cm
Serrated, flexible shaft



Brand Tendon Tunelling Forceps
10-958 15cm
10-959 19cm
10-960 24cm
Straight, serrated
2 x 3 teeth



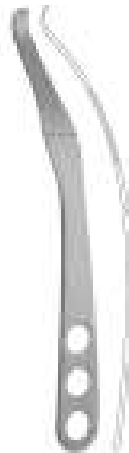
Hohmann Bone Elevator
10-961 43mm
24.5 cm



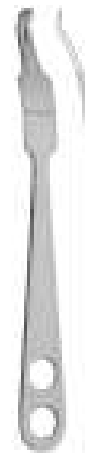
Hohmann Bone Elevator
10-962 22mm
25cm



Hohmann Bone Elevator
10-963 33mm
28cm



Hohmann Bone Elevator
10-964 24mm
26.5cm



Hohmann Bone Elevator
10-965 22mm
26cm



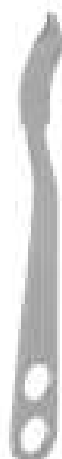
Capsule Retractor
10-966 25.5cm
3 sharp-pronged,
22mm width blade



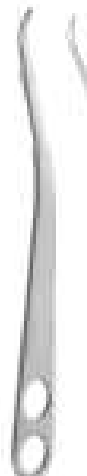
Bristow-Bankart Humeral Retractor
10-967 19cm
Double-pronged,
25mm width x 102mm
depth blade



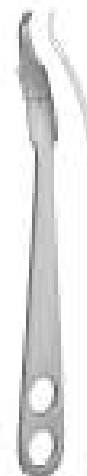
Bristow-Bankart Soft Tissue Retractor
10-968 20cm
3-pronged
21mm width blade,



Humeral Head Retractor
10-969 22cm
18mm width blade



Hohmann Bone Elevator
10-970 22cm
08mm width blade
10-971 23cm
10mm width blade



Hohmann Bone Elevator
10-972 24cm
18mm



Hohmann Bone Elevator
10-973 24cm 70mm
10-974 28.5cm 35mm width blade
10-975 33cm 40mm width blade

BONE LEVERS

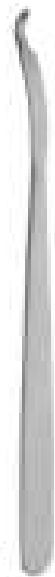


Knochenhebel
Leviers a os

Elevadores para huesos
Elevatori per osso



**Hohmann Long
Shank Retractor**
10-976 23cm
43mm width blade



**Mini-Hohmann
Bone Elevator**



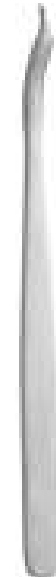
10-977 16cm
6mm width
blade



10-978 16cm
8mm width
blade



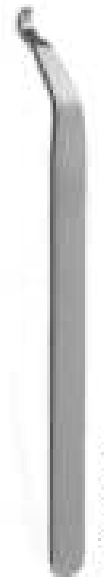
**Hohmann
Bone Lever**
10-979
15cm



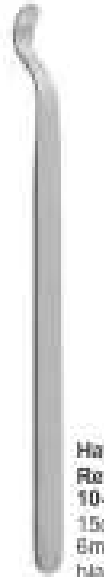
**Hohmann
Bone Lever**
10-980
15.4cm
Short tip



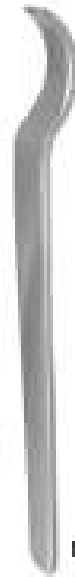
**Hohmann
Retractor**
10-981
15cm
15mm width
blade



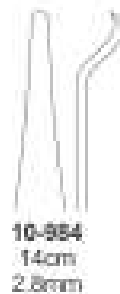
**Hayes Hand
Retractor**
10-982
16cm
3mm width
blade



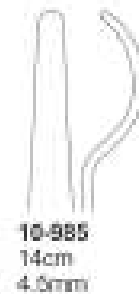
**Hayes Hand
Retractor**
10-983
15cm
6mm width
blade



Bone Lever



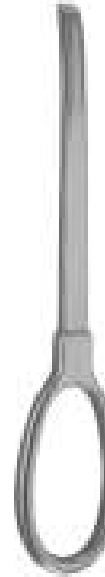
10-984
14cm
2.6mm



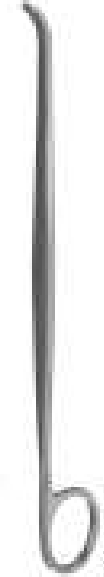
10-985
14cm
4.0mm



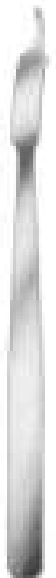
10-986
14cm
6mm



**Bristow Bone
Lever**
10-987
23cm



**Lane Bone
Lever**
10-988
21cm



Periosteal Elevator 17.5cm
For Metacarpals Small
10-989 5 mm width
For Metacarpals Medium
10-990 10 mm width
Light Curve, Rounded End,
10-991 5 mm width
Contra Angled Curve
10-992 4.5 mm width



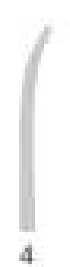
1



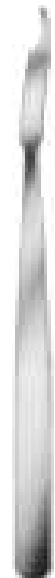
2



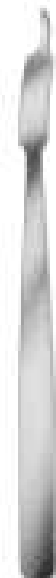
3



4



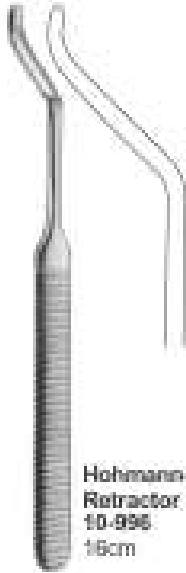
Hohmann Retractor
10-993 13cm
Small, width 6 mm
short, narrow tip



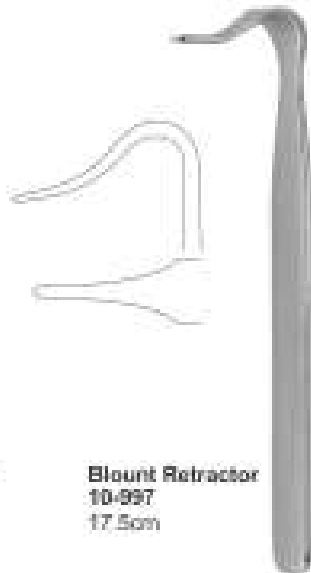
Hohmann Retractor
10-994 18cm
Small, width 8 mm
short, narrow tip



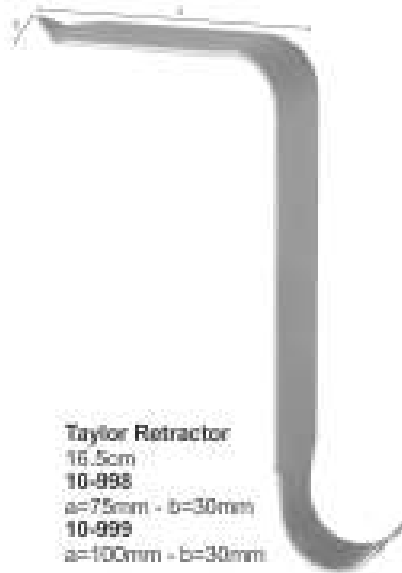
Hohmann Retractor
10-995 12.5cm
Finger Ring handle,
16mm width blade



**Hohmann-Williger
Retractor**
10-996
16cm



Blount Retractor
10-997
17.5cm



Taylor Retractor
16.5cm
10-998
a=75mm - b=30mm
10-999
a=100mm - b=30mm



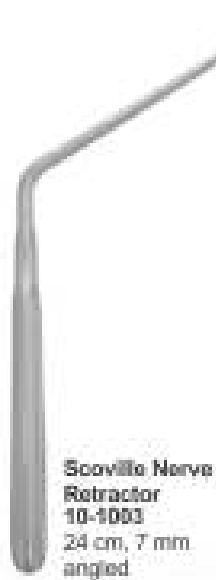
**Cushing Vein
Retractor**
10-1000 22.5cm
with fenestrated
handle
Blade 12 mm
width x 10 mm



**Cushing
Decompression
Retractor**
10-1001 21.5cm
with fenestrated
blade and handle
Blade 13 mm
width x 22 mm



**Scoville Nerve
Retractor**
10-1002
24cm
7 mm
straight



**Scoville Nerve
Retractor**
10-1003
24 cm, 7 mm
angled



Taylor Retractor
17cm
10-1004 30 x 75-mm
10-1005 30 x 100 mm



Hibbs Retractor
10-1006
25 x 75 mm, 23cm
10-1007
25 x 80 mm, 24cm



Moyending Retractor
10-1008
16 X 50 mm, 20cm
10-1009
25 X 75 mm, 23cm
10-1010
50 X 90 mm, 24cm



**Nail
Extracting
Forceps**
10-1011
14cm



**Nail Extracting
Forceps**
10-1012
14.5cm

ORTHOPAEDICS, TENDON STRIPPERS



Orthopédie, Sehnenstripper

Orthopédie, enucleadores de tendones

Ortopedia, Instruments a ecorcher les tendons

Ortopedia, Scalfatendini



10-1014 10-1015 10-1016

Frill points only

Finger Nail Drill
with 3 drill points
10-1013



Nail Splitting
Forceps
10-1017
13.5cm



10-1019
Saw Blade Only
for 10-1018

Ring Cutter
10-1018
17cm



10-1021
Saw Blade Only
for 10-1020

Ring Cutter
10-1020
17cm



Tendon Tunelling Forceps
10-1022 13cm



10-1023
15cm

Tendon Tunelling Forceps

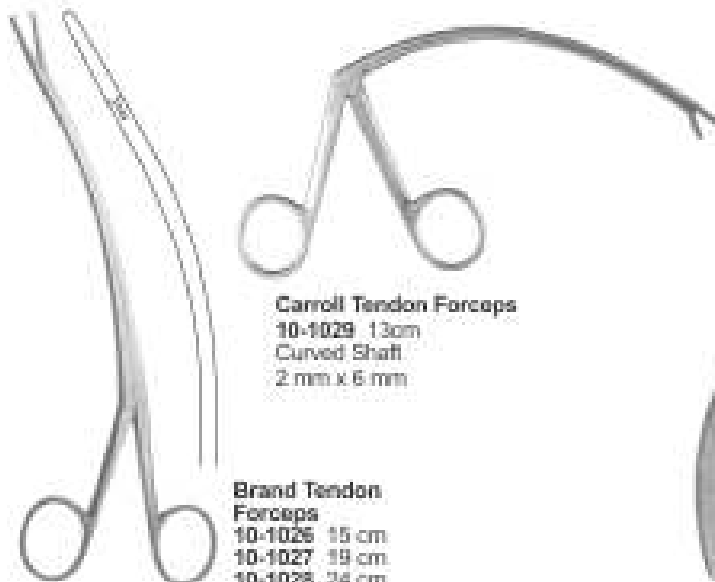


10-1024
15.25cm
6 mm

Tendon Tunelling Forceps



Lead Hand
10-1025 Adult Size



Carroll Tendon Forceps
10-1029 13cm
Curved Shaft
2 mm x 6 mm

Brand Tendon
Forceps
10-1026 15 cm
10-1027 19 cm
10-1028 24 cm



Needle
Nose
Pliers

10-1030
14cm
Cross
serrated



Needle
Nose
Pliers

10-1031
15cm
Serrated



Flat Nose
Plier
10-1032
15cm

Sehnenstripper, Technische Zangen

enucleadores de tendones, Pinzas técnicas

Instruments à écorcher les tendons, Pinces techniques

Scollatendini, Pinze tecniche



Flat Nose Pliers
10-1033
13.5cm
Broad, 4mm tip



Flat Nose Pliers
10-1034 16.5cm
Combination plier and
cutter



Needle Nose Pliers
10-1035 13.5cm



Flat Nose Pliers
10-1036
15cm Delicate,
1.5mm tip



K-Wire Extraction Pliers
W/Screw Lock
10-1037
13cm, 3mm tip



Flat Nose
K-Wire Pliers
10-1038
14cm
10-1039
17cm



Nose Pliers
10-1040
17cm



Utility Technical
Forceps Pliers
10-1041 19cm
adjustable



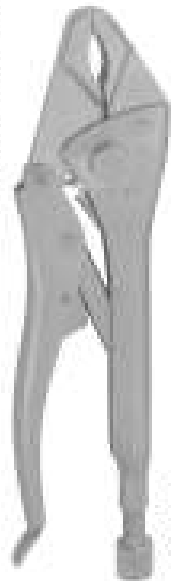
Wire Bending
Forceps
10-1042 18.5cm



Flat Nose Plier
10-1043 18.5cm
parallel grip, incorporated
cutter, for hard wires up to
1.8mm

Technische Zangen
Pinças técnicas

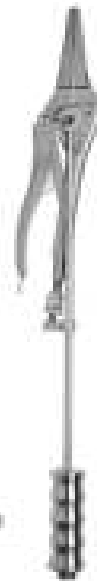
Pinças técnicas
Pinze tecniche



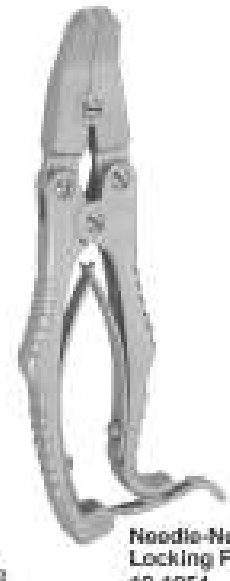
Locking Plier
10-1044 18cm
10-1045 20cm
10-1046 24cm



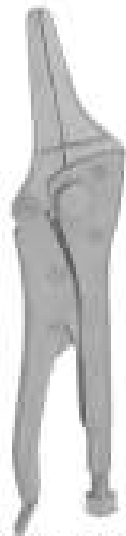
Plate Bending Plier
10-1047 20cm
for plates up to 2.7mm
10-1048 24cm
for plates up to 4mm



Locking Plier
10-1049 22cm
10-1050 25cm
10-1051 30cm
Locking plier, only
10-1052 30cm
with holding pins
10-1053 45cm
with extraction device



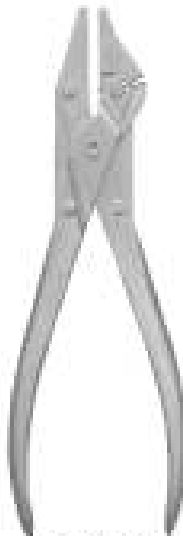
Needle-Nose Locking Pliers
10-1054



Needle-Nose Locking Pliers
10-1055



Needle-Nose Locking Pliers
10-1056



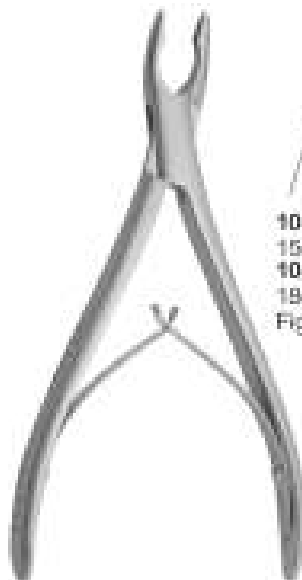
Flat Nosed Plier
10-1057 18cm
parallel, with lateral
wire cutter



Cast Spreader Model Usa
10-1058 23cm
3 Prong

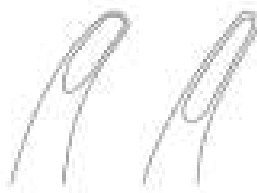


Nail Extractor
10-1059 15cm
with Longitudinal Groove
(for Intramedullary Gliding Nails)



10-1060
15cm
10-1061
18cm
Fig.1

Luer Bone Rongeur
Single action
Curved, 8 x 12mm



10-1062
15cm
10-1063
18cm
Fig.2



10-1064
17cm
Fig. 1

Luer Bone Rongeur
Single action,
Straight, 8 x 12mm



10-1065
17cm
Fig. 2



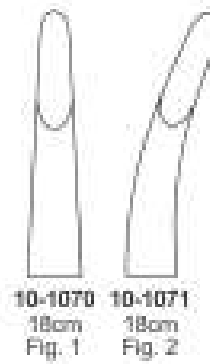
Friedmann Bone Rongeur
10-1066 14.5cm
Single action, Curved,
4 x 11mm

Hohlmeißelzangen
Pinzas gubias

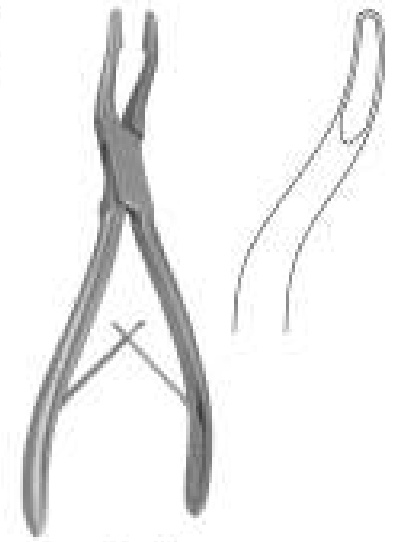
Pinces-gauges
Pinze-sgarbie



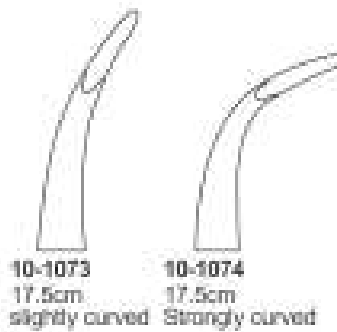
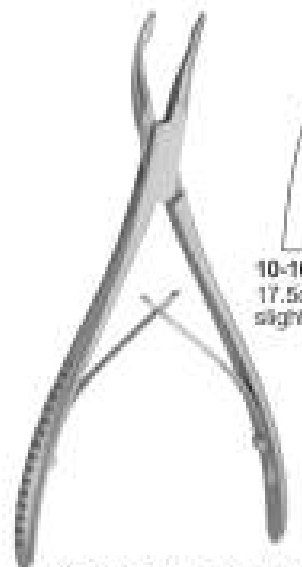
Blumenthal Bone Rongeur



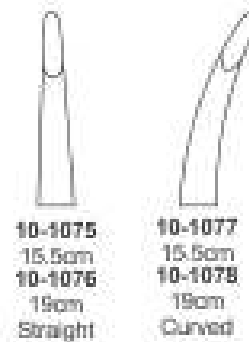
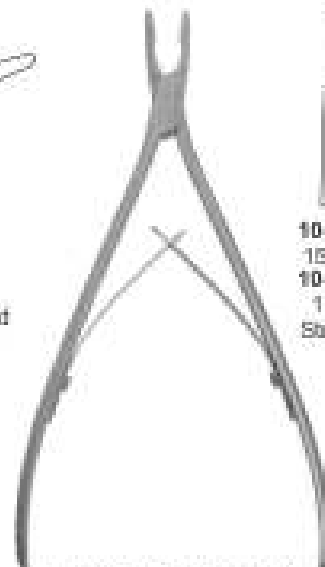
Jasen Bone Rongeur



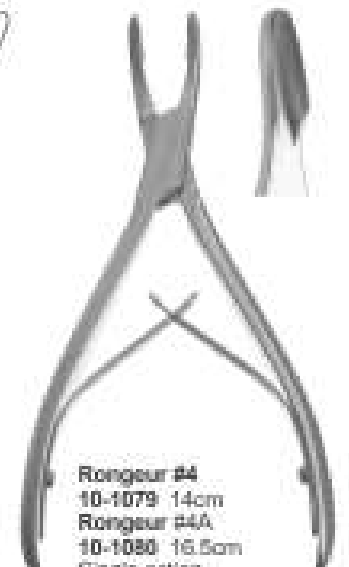
Jansen Bone Rongeur
10-1072 19cm



Steibrink Bone Rongeur



Lempert Bone Rongeur



Rongeur #4
10-1079 14cm
Rongeur #4A
10-1080 16.5cm
Single action,
Curved, 4 x 9mm



Chichirelli (Blumenthal) Rongeur
10-1081 15cm
Single action, Curved 45°,
4 x 13mm



Dean (Blumenthal) Rongeur
10-1082 15cm
Single action,
Curved 90°, 4 x 11mm



Dean Rongeur
10-1083 14.5cm
Single action
Curved, 3mm

Hohlmittelzangen
Pinzas gubias

Pinces-gauges
Pinze-sgorbie



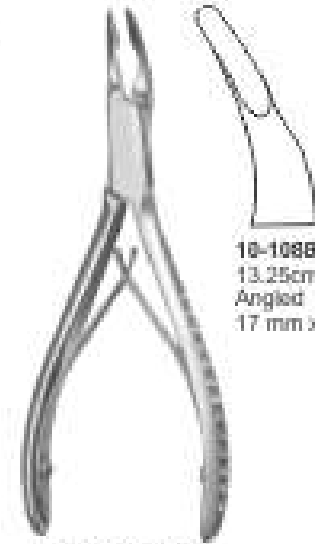
Hartmann Bone Rongeur
10-1084 18.5cm
Single action
Curved, 4 x 14mm



Mead Bone Rongeur
10-1085 16.5cm
Single action,
Curved, 5 x 13mm

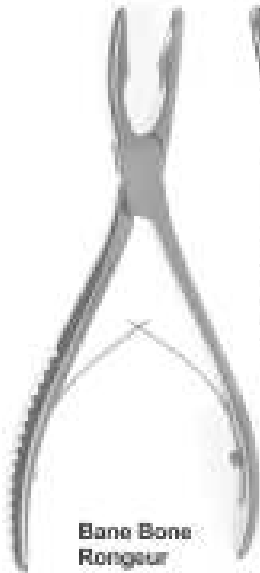


Cleveland Bone Rongeur
10-1086 14cm
10-1087 17cm



Universal Bone Rongeur

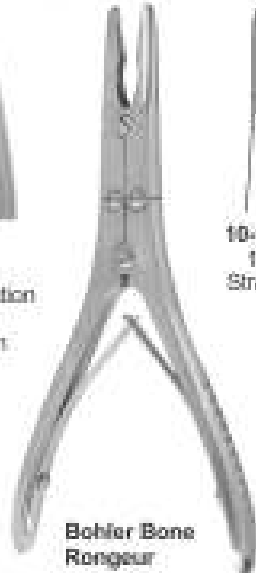
10-1088
13.25cm
Angled
17 mm x 3.5 mm



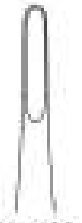
Bane Bone Rongeur



10-1089
18cm
Single action
Curved,
3 x 18mm



Bohler Bone Rongeur



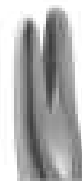
10-1090
15cm
Straight



10-1091
15cm
Curved



Zaufal-Jansen Bone Rongeur
10-1092 18cm
Double action
Curved, 5x15mm



Marquardt Bone Rongeur
10-1093 18cm



Beyer Bone Rongeur
18cm
10-1094 3 x 14mm
10-1095 4 x 15mm
Double action, Curved



Smith-Peterson Laminectomy Rongeur
10-1096 24cm
Double action,
Straight 3 x 15mm



Smith-Peterson Laminectomy Rongeur
10-1097 24cm
Double action,
Curved 3 x 18mm

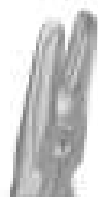
BONE RONGEURS

Hohlmelßzangen
Pinças gubias

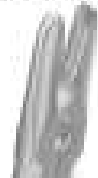
Pinces-gauges
Pinze-sgorbie



Ruskin Rongeur
10-1098 18cm 4x16mm
10-1099 18.5cm 5x10mm
Double action, Curved on side



Ruskin Rongeur
10-1100 18.5cm
Double action, 6 x 16mm,
Straight, Curved



Ruskin Rongeur
10-1101 15.5cm Straight, 3.2mm
10-1102 15cm Curved, 2 x 15mm
10-1103 15cm Curved, 3 x 15mm
Double action,



Ruskin Bone Rongeur



10-1104 15.5cm
10-1105 18cm
Double action
Straight, 2 x 14mm



10-1106 15.5cm
10-1107 18cm
Double action
Curved 2 x 14mm



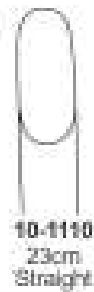
Mayfield Bone Rongeur
10-1108 18cm



Stille-Ruskin Bone Rongeur



10-1109
23cm
Curved



10-1110
23cm
Straight



Leksell Bone Rongeur
10-1111 24.5cm 5 x 13mm
10-1112 24cm 8 x 14.5mm
Double action, Curved 50°



Leksell Rongeur
10-1113 24cm
6 x 16mm
10-1114 24cm
7 x 13mm
Double action, Curved



Leksell Rongeur
10-1115 24cm
3 x 18mm
Double action, Curved



Leksell Rongeur
10-1116 23cm
4 x 13mm
Double action
Fully curved



Stille Bone Rongeur



10-1117
23cm
4mm



10-1118
23cm
6mm



10-1119
23cm
8mm



Stille-Luer Rongeur Forceps



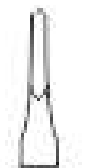
10-1120
23cm
10-1121
27cm
straight



10-1122
23cm
10-1123
27cm
curved



Echlin Duckbill Bone Rongeur 23cm



10-1124
2 x 12mm
Double action
Curved on side



10-1125
3 x 12mm
Double action
Curved on side



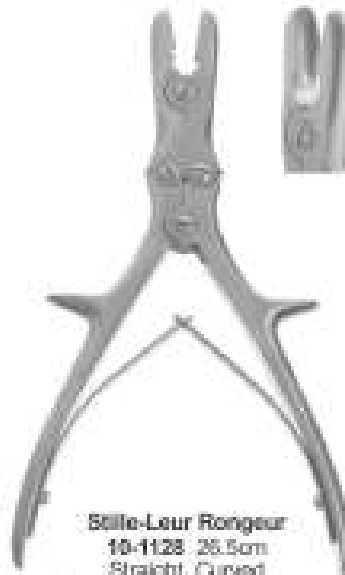
10-1126
4.5 x 11mm
Double action
Curved on side

Hohlmelbelangen
Pinzas gubias

Pinces-gouges
Pinze-sgarbie



Stille-Luer Rongeur
10-1127 21.5cm
Curved, Straight
Double action, 10 x 18mm



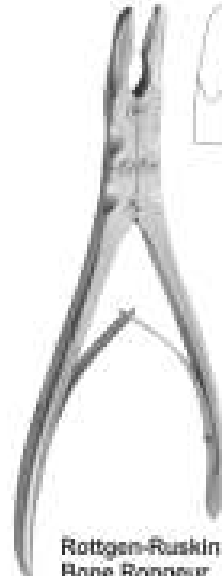
Stille-Luer Rongeur
10-1128 26.5cm
Straight, Curved
Double action, 10 x 18mm



**Stille-Luer Echlin
Duckbill Rongeur**
23cm
10-1129 6 x 13mm
10-1130 6 x 15mm
Double action Curved on side



Stille-Luer Rongeur
10-1131 21.5cm
Double action
Curved 10 x 18mm



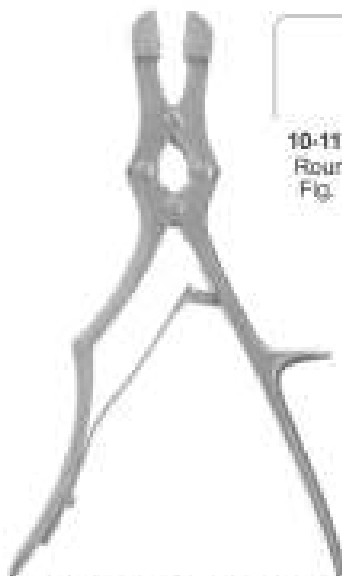
**Rottgen-Ruskin
Bone Rongeur**
10-1132 23cm



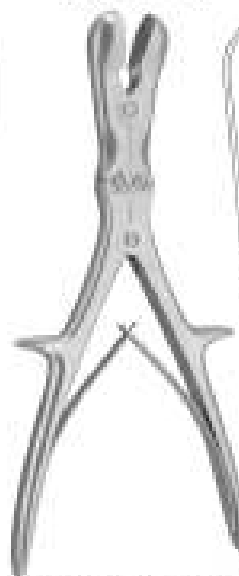
Somb Bone Rongeur
10-1133 24cm



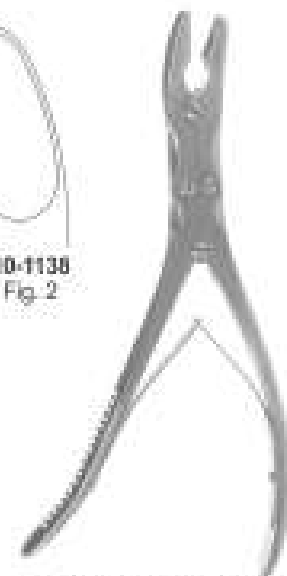
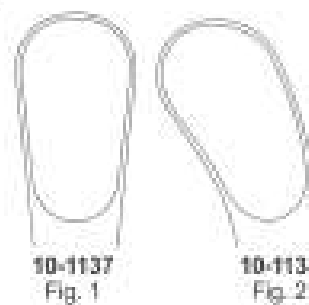
Frykholm Bone Rongeur
10-1134 24cm



Sauerbruch Bone Rongeur
30cm



Luer-Stille Bone Rongeur
27cm



Leksell-Stille Bone Rongeur



BONE RONGEURS

Hohlmelßzangen
Pinças gubias

Pinces-gauges
Pinze-sgarbie



Leksell Bonerongeur

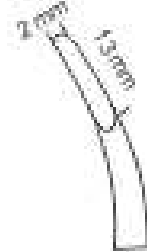
10-1141 25cm 3 x 16mm
10-1142 23cm 5 x 16mm
10-1143 25cm 4.5 x 16mm
10-1144 25cm 6 x 16mm
10-1145 25cm 7 x 16mm
10-1146 25cm 8 x 16mm
Double action, Curved 15°



Hakansson Bone Rongeur
10-1147 20cm



Kleinert-Kutz Bone Rongeur



10-1148
15.25cm
2 x 13 mm



Ruskin-Mini Bone Rongeur



10-1149
15.25cm
Curved
18 x 5 mm



Syfert Rongeur
10-1150 35.5cm 4 x 16mm
10-1151 35.5cm 8 x 16mm
10-1152 35.5cm 12 x 16mm
10-1153 37cm 5 x 16mm
Double action, Angled



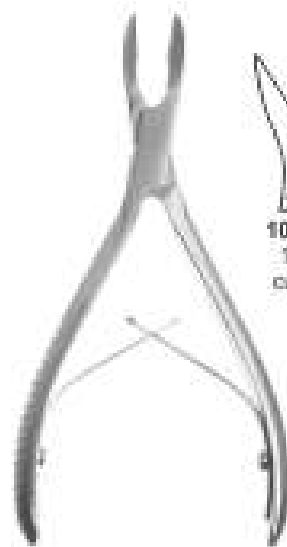
Cottle-Kazanjian Bone
Cutting Rongeur Forceps
10-1154 19cm



Littauer / Liston Bone
Cutting Rongeur Forceps



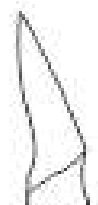
10-1155
15cm
Straight



Cleveland Bone Cutting
Rongeur Forceps



10-1156
15cm
curved



10-1157
17cm
curved



Liston Bone Cutting
Rongeur Forceps



10-1158
14cm
Angled



10-1159
17cm
Angled



10-1160
19cm
Angled



10-1161
22cm
Angled

BONE CUTTING FORCEPS



Knochensplitterzangen
Pinces cortantes a os

Pinzas cortantes para huesos
Cesole per ossa



10-1162 14 cm
10-1163 17 cm
10-1164 19 cm
10-1165 20 cm
10-1166 22 cm
Straight

Liston Bone Cutting Rongeur Forceps



10-1167 27 cm
Straight



10-1168 27 cm
Angled 45°

Stille-Liston Bone Cutting Rongeur Forceps



Semb Bone Cutting Rongeur Forceps
10-1170 24cm



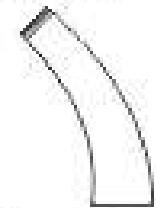
Liston Key Horsley Bone Cutting Rongeur Forceps
10-1171 27cm



Horsley Bone Cutting Rongeur Forceps 10-1172 25cm

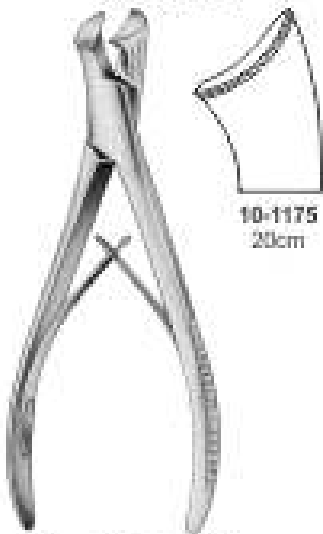


Ruskin Bone Cutting Rongeur Forceps
10-1173 20cm
Double-Action



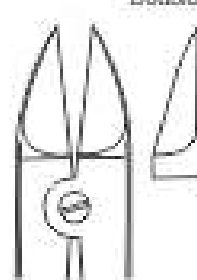
10-1174
16cm

Cleveland-Gardner Bone Cutting Rongeur Forceps



10-1175
20cm

Markwalder Bone Cutting Rongeur Forceps



Bone Cutting Rongeur Forceps
10-1176 15cm



10-1177
15cm
Straight



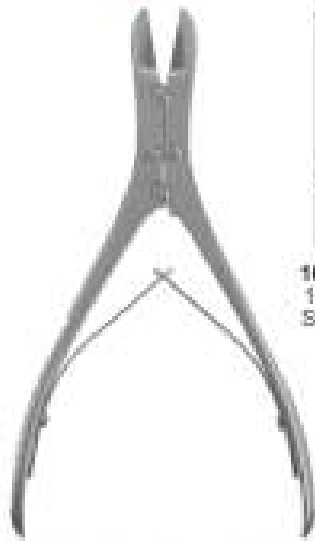
10-1178
15cm
Angled

Bohler Bone Cutting Rongeur Forceps

BONE CUTTING FORCEPS

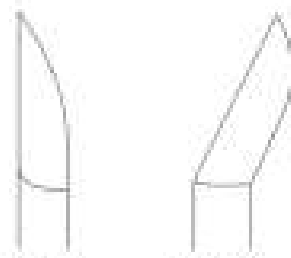
Knochensplitterzangen
Pinces coupantes a os

Pinzas cortantes para huesos
Cesole per ossa



10-1179
18.5cm
Straight

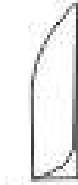
**Ruskin-Liston Bone Cutting
Rongeur Forceps**



10-1180
18.5cm
Angled



**Walton-Liston Bone Cutting
Rongeur Forceps**



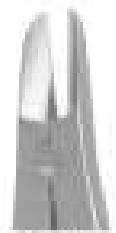
10-1181
15cm
Straight



10-1182
15cm
Angled



**Ruskin-Liston Bone Cutting
Rongeur Forceps**



10-1183 Straight
10-1184 Curved
10-1185 Angled
19cm delicate



**Mc Indoe Bone Cutting
Rongeur Forceps**



10-1186
17.5cm
Straight



10-1187
17.5cm
Curved



**Mc Indoe Bone
Cutting Forceps
10-1188 18cm
Angled, delicate.**



**Kleinert-Kutz Bone
Cutting Forceps
10-1189 15cm
Straight, delicate.**



**Kleinert-Kutz
Synovectomy Rongeur
10-1190 15cm 2 x 10mm
Double action,
Curved on side, delicate.**



**Stille-Liston Bone Cutting
Rongeur Forceps**



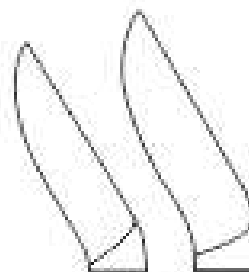
10-1191
27cm
Straight



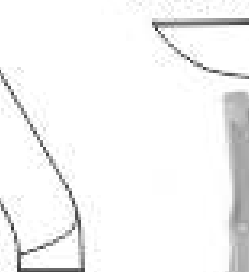
**Stille-Horsley Bone Cutting
Forceps
10-1192 24cm**



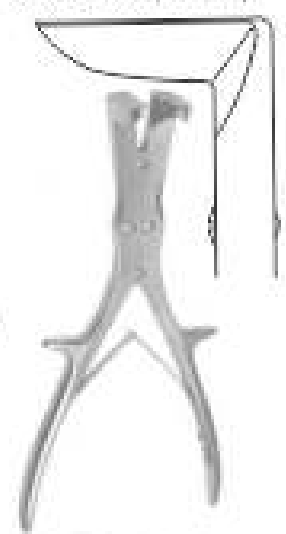
**Liston Bone Cutting
Rongeur Forceps**



10-1193
23cm
Angled



10-1194
27cm
Angled



**Liston-Stille Bone Cutting
Rongeur Forceps
10-1195 26cm**

WIRE CUTTING INSTRUMENTS



Drahtschneidezangen
Pincas caupantes

Alicates para cortar alambre
Pinze taglia filo



Vital Wire Cutter
10-1196 22cm
for hard wires up to 2.2mm,
for soft wires up to 3mm



Vital Wire Cutter
10-1197 22cm
for hard wires up to 2.2mm,
for soft wires up to 2.8mm



Vital Wire Cutter
10-1198 23cm
for hard wires up to 2.2mm,
for soft wires up to 3mm



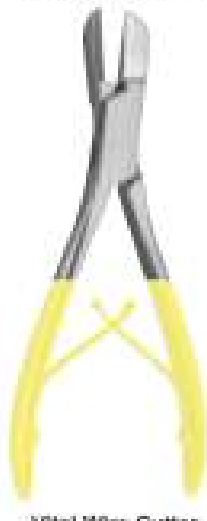
Vital Wire Cutter
10-1199 18cm
for hard wires up to 1.5mm,
for soft wires up to 2mm



**Pin Puller W/
Groove TC**
10-1200 14cm



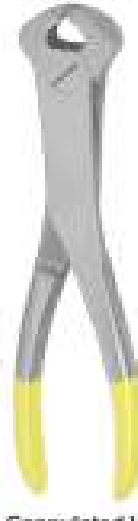
Vital Wire Cutter
10-1201 18cm
for hard wires up to 1.7mm,
for soft wires up to 2mm



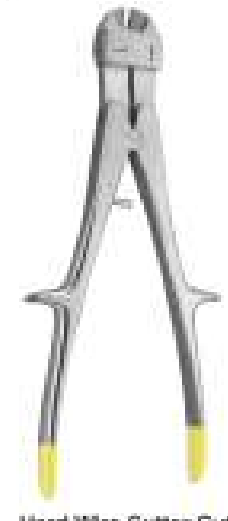
Vital Wire Cutter
10-1202 15cm
for hard wires up to 1mm,
for soft wires up to 1.5mm



Vital Wire Cutter
10-1203 14.5cm
for hard wires up to 1mm,
for soft wires up to 1mm



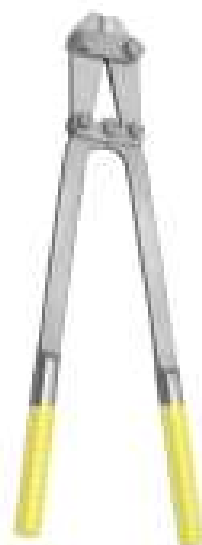
**Cannulated Wire
/ Pin Cutter**
10-1204 13cm
Cuts wire upto 1.8 mm



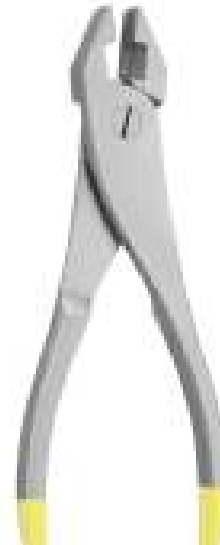
Hard Wire Cutter Cuts
10-1205 26cm
for hard wires up to 3mm



**Kirschner Wires &
Steinmann
Pins Cutter**
10-1206 57cm
up to 6mm



Side Pin Cutter
10-1207
57.5cm
Side cutting w/
carbide inserts
max. cap: 5/32"



**Vital Heavy
Duty Pliers TC**
10-1208
22cm
Grip Forceps,
Combined
with cutter



**Vital Wire
Extraction
Pliers TC**
10-1209 5mm
10-1210 7mm
15cm



Side Cutter
10-1211 18.5cm
Welded carbide jaws
max capacity: 1.8mm



Delicate Wire Cutter
10-1212 12.5cm
Side cutting w/ carbide inserts
max capacity: 0.7mm



Front & Side Wire Cutter
10-1213 17cm
Front and side cutting w/ carbide inserts,
double action. Max capacity: 1.6mm



Double Action Wire Cutter
Angled, Side cutting w/
carbide inserts
10-1214 17cm
max cap: 1.6mm
10-1215 21.5cm
max cap: 2.4mm



Flush Wire Cutter
10-1216 17cm
Front and side cutting w/ carbide inserts,
double action. Max capacity: 1.5mm



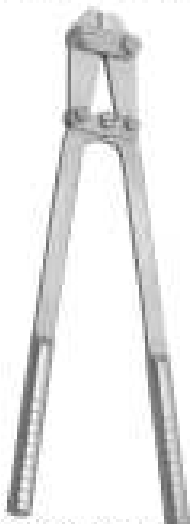
Wire Forceps
10-1217 17cm
Straight, serrated 5.4 mm tip



Pin Cutter Small
10-1218 26cm
Max cap: 3.2mm



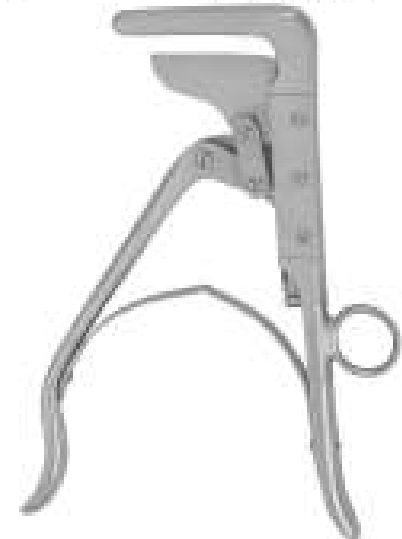
Pin Cutter Medium
10-1219 36.5cm
Max cap: 4.7mm



Large Pin Cutter
10-1220 57.5cm
Large, Straight, Max
capacity 6.3mm



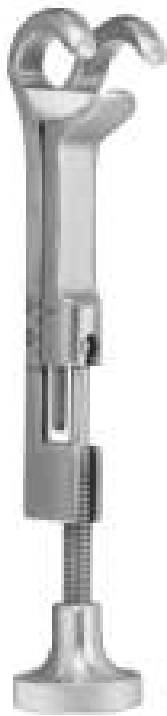
Stille Plaster Shear
10-1221 37cm



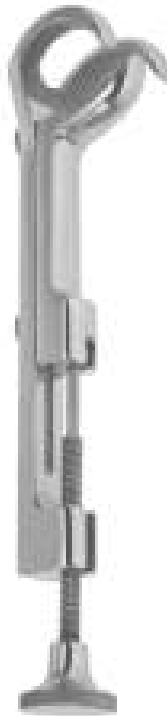
**Schumacher Sternum
Shears**
10-1222 21cm

BONE HOLDING CLAMPS - BONE HOLDING FORCEPS

Knochenhalteklammern - Knochenhaltezangen | *Pinzas porta huesos - Pinzas para huesos*
Daviers a os - Daviers porte-os | *Tenaglie per ossa*



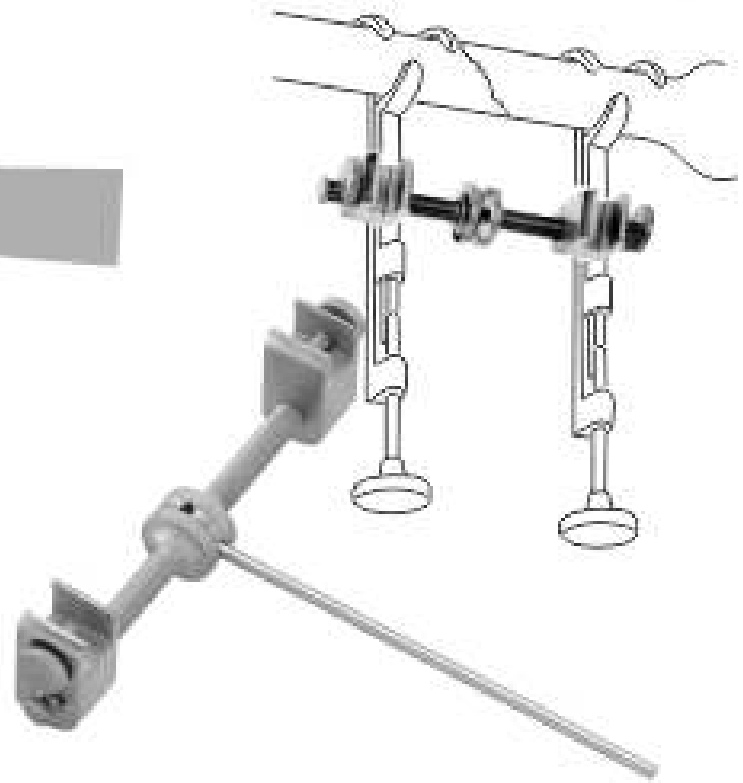
Gerster-Lowmann Bone Clamp
 10-1223 12cm
 10-1224 14,5cm
 10-1225 18cm, 28mm
 10-1226 20cm, 35mm
 10-1227 22cm, 40mm
 1x2 Jaws



Lowmann Bone Clamp
 10-1228 12cm
 10-1229 15cm
 10-1230 17cm
 10-1231 18,5cm
 10-1232 20cm



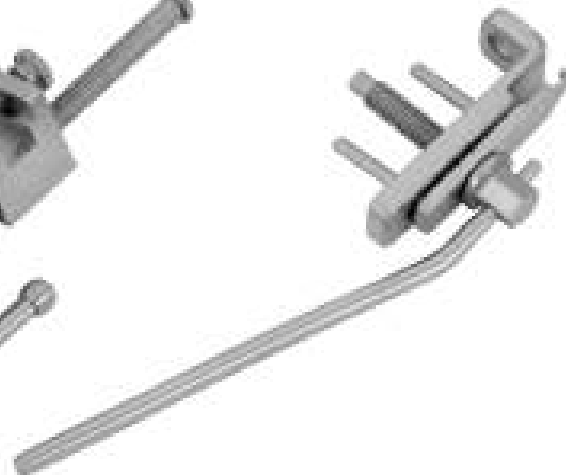
Lamberti-Lowman Bone Clamp
 10-1233 17,5cm
 10-1234 20,3cm
 2x2 Jaws



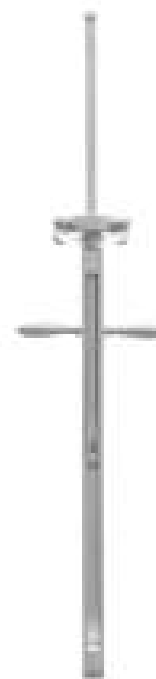
Gerster Bone Holding Clamp
 10-1235 15cm



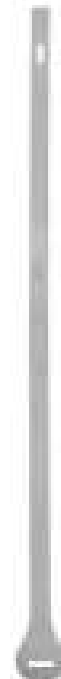
Gerster Bone Holding Clamp
 10-1236



Gerster Bone Holding Clamp
 10-1237



Parham-Martin Bone Clamp
 10-1238 21cm
 Straight



Parham Martin Bands
 10-1239 19cm

Knochenhaltezzangen - Repositionszangen
Daviers parte-sa-pinces de reposition

Pinzas para huesos - pinzas para reposicion
Tenaglie per ossa - Pinze per riposizioni



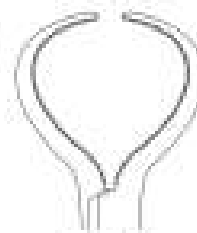
Bone Reduction Forceps
10-1240 13.5cm



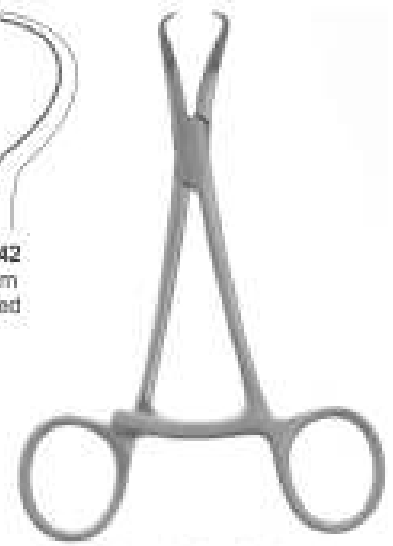
Locke Phalangeal Forceps
10-1241 14cm



Lewin Perforating Bone Holding Forceps



10-1242
17.5cm
serrated

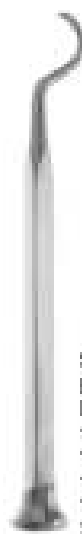


Stagbeetle Bone Reduction Forceps
10-1243 Pointed tips, 13cm



10-1244
13.5cm
Angled
Serrated

Bone Reduction Orthopedic Forceps



Shoulder Percussion Awl
Pointed, 21.5cm
10-1245 Small
10-1246 Medium
10-1247 Large
10-1248 Pointed, 23.5cm



Meniscus Clamp
10-1249 13.5cm
Serrated



Meniscus Clamp
10-1250 13.5cm
Angled 20°, serrated



Preston Ligamentum Flavum Forceps
10-1251 19cm
Curved, 1 x 2 teeth



Meniscus Clamp
10-1252 18cm
Straight, Curved shaft



Dingman Bone Clamp
10-1253 19cm
Straight, Serrated,
1 1/2" tip length, Curved shaft



Fergusson Bone Holding Forceps
10-1254 21cm 2 x 2 teeth

BONE HOLDING FORCEPS

Knochenhaltezangen
Dauers porte-sa

Pinzas para huesos
Tenaglie per ossa



10-1255
23cm

Van Buren Sequestrum Forceps
Curved on side, serrated



Langenbeck Bone Holding Forceps
10-1256 21cm



Semb Bone Holding Forceps
10-1257 19cm without ratchet
curved sideways deep teeth

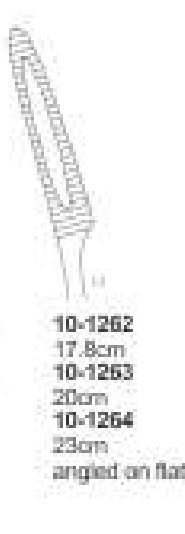


Semb Bone Holding Forceps
10-1258 20.3cm, with ratchet
curved sideways deep teeth

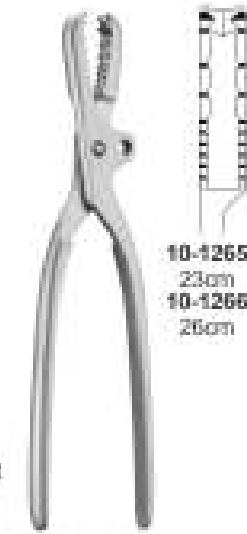


10-1259 17.8cm
10-1260 20cm
10-1261 23cm
straight

Sequestrum (Niroosis) Bone Holding Forceps



10-1262 17.8cm
10-1263 20cm
10-1264 23cm
angled on flat



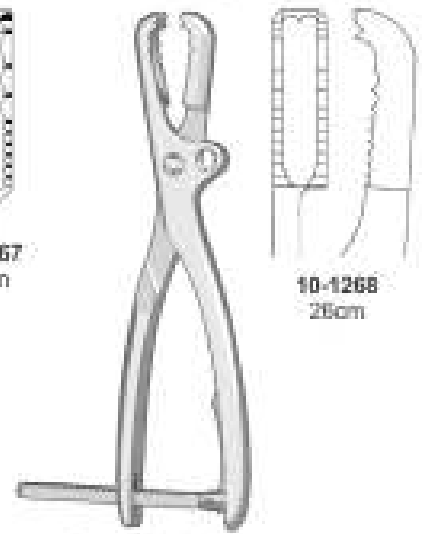
10-1265 23cm
10-1266 26cm

Farabeuf Bone Holding Forceps
with adjustable jaw



10-1267 26cm

Farabeuf-Lambotte Bone Holding Forceps
with adjustable jaw



10-1268 26cm

Farabeuf-Lambotte Bone Holding Forceps
with adjustable jaw



Bishop Bone Clamp
10-1269 22.5cm
Straight



Kern Bone Holding Forceps
10-1270 17cm
10-1271 24cm
without ratchet



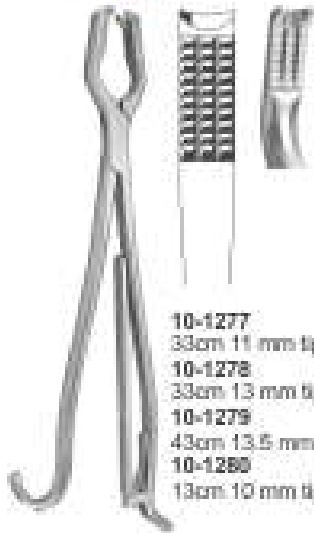
Kern Bone Holding Forceps
10-1272 17cm
10-1273 24cm
with ratchet



10-1274 21cm
10-1275 27cm
10-1276 30cm
Hey Groves Bone Holding Forceps

Knochenhaltetzangen
Dauers parte-so

Pinzas para huesos
Tenaglia per ossa

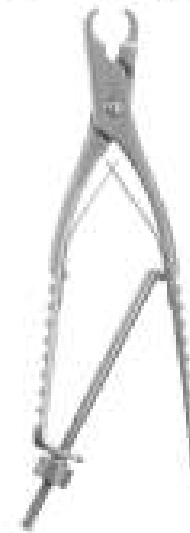


10-1277
33cm 11 mm tip W/ Ratchet
10-1278
33cm 13 mm tip W/ Ratchet
10-1279
43cm 13.5 mm tip W/ Ratchet
10-1280
13cm 10 mm tip W/o Ratchet

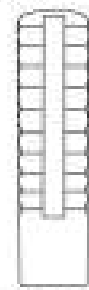
Lane Bone Holding Forceps Light Model



Lane Bone Holding Forceps
10-1281 33cm 13 mm tip
10-1282 43cm 12 mm tip without ratchet



Ulrich Bone Holding Self Retaining Forceps



10-1283 19 cm mini
10-1284 22 cm
10-1285 26 cm
10-1286 28 cm
Straight with speed lock



10-1287 19cm
10-1288 22cm
10-1289 26cm
10-1290 28cm
Angular, with speed lock

Ulrich Bone Holding Forceps



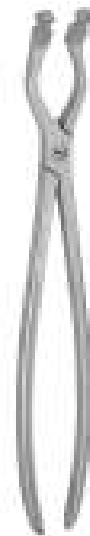
10-1291
28cm

Ulrich Bone Holding Forceps Angular With Speed Lock & swivel jaw

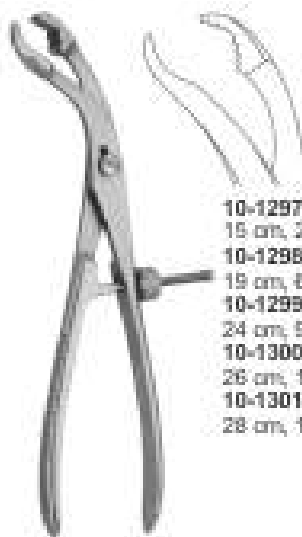


10-1292
22cm
10-1293
27cm
10-1294
30cm

Lambotte Bone Holding Forceps One-Jaw Mobile adjustable jaw



Lane Bone Holding Forceps
10-1295 31.5cm
10-1296 39cm



10-1297
15 cm, 2.5mm
10-1298
19 cm, 6.5mm
10-1299
24 cm, 9.5mm
10-1300
26 cm, 10mm
10-1301
28 cm, 11mm

Lambotte Bone Holding Forceps Self-Centering, with speed lock



Subacromion Spreader
10-1302 26.75cm Right
10-1303 26.75cm Left



Bone Reduction Forceps
10-1304 14cm
Serrated with pointed tips

BONE HOLDING FORCEPS



Knochenhaltezaangen
Dauers porte-sa

Pinzas para huesos
Tenaglie per ossa



Bone Reduction Forceps
10-1305 14cm Curved
10-1306 15cm Serrated



10-1307
14cm Serrated
10-1308
14cm Curved
10-1309
17cm Curved

**Bone Reduction Forceps,
Pointed Tips**



Semb Bone Holding Forceps
Curved on side
10-1310 19cm 4 x 5-teeth
10-1311 21cm 5 x 5 teeth



**Martin Cartilage Bone Holding
Clamp Forceps**
10-1312 19 cm Str.



10-1313
20cm
Str

**Bircher-Ganske
Bone Holding Forceps**

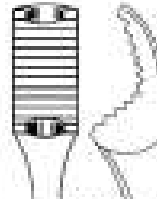


10-1314
20cm
Cvd.

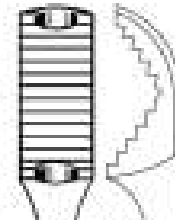


10-1315
17.5cm
5.0mm

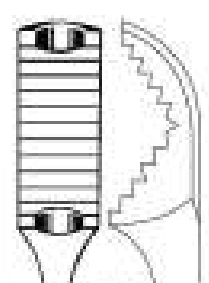
**Verbrugge Bone
Holding Forceps**



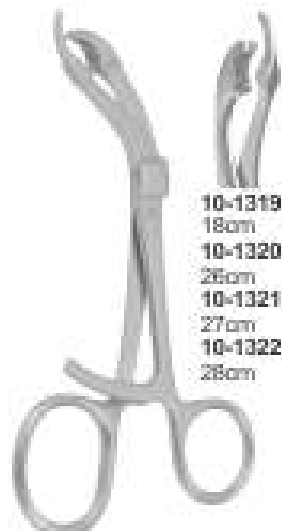
10-1316
25cm
9.5mm



10-1317
28cm
10.5mm

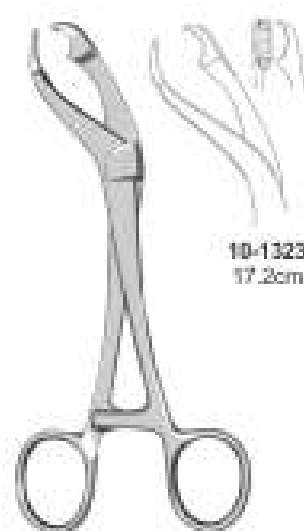


10-1318
27cm
12.0mm



10-1319
18cm
10-1320
26cm
10-1321
27cm
10-1322
28cm

**Verbrugge Bone
Holding Forceps
w/ Long Ratchet**



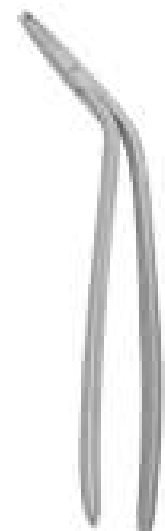
10-1323
17.2cm

**Verbrugge Bone Holding
Forceps
with short ratchet**



10-1324 15 cm
10-1325 19 cm
10-1326 24 cm
10-1327 26 cm
10-1328 29 cm

**Verbrugge Self-Centering
Bone Holding Forceps
with long ratchet**



**Lane Bone Plate Holding
Forceps**
10-1329 22cm

BONE HOLDING FORCEPS

Knochenhaltetzangen
Dauiers porte-os

Pinzas para huesos
Tenaglie per ossa



Verbrugge Bone Holding Forceps
10-1330 18cm



Verbrugge Bone Holding Forceps
10-1331 18cm



10-1332
25cm
10-1333
26cm
10-1334
27cm

Verbrugge Bone Holding Forceps



10-1335
25cm
10-1336
26cm
10-1337
27cm

Verbrugge Bone Holding Forceps



Verbrugge Bone Holding Forceps
10-1338 18cm



10-1339
25cm
10-1340
26cm
10-1341
27cm

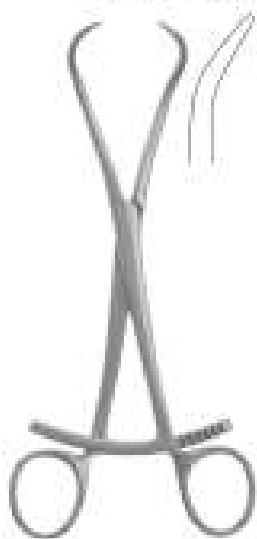
Verbrugge Bone Holding Forceps



Bone Reduction Forceps
10-1342 13.5cm



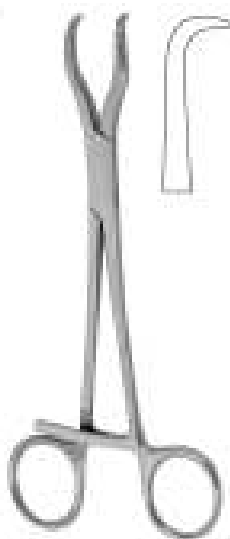
Reill Bone Reduction Forceps
10-1343 17cm
Curved, pointed tips



Bone Reduction Forceps
10-1344 20.4cm
Pointed tips



Bone Reduction Forceps
10-1345 13.5cm
for maxillary reposition



Hasse
10-1346 16.5cm
for mandibular fractures



Bone Holding forceps

10-1347
9.5cm

10-1348
9.5cm

BONE HOLDING FORCEPS

Knochenhitzzangen
Dauiers porte-os

Pinzas para huesos
Tenaglie per ossa



Fibula Bone Holding Forceps
10-1349 22cm



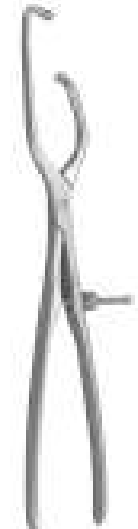
Glenoid Perforating Forceps
10-1350 17cm
Lightly curved, pointed tips
Strongly curved, pointed tips



Nail Bone Holding Forceps
10-1351 17cm



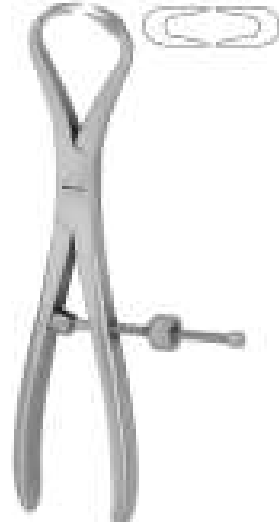
Bone Reduction Forceps with Points
10-1352 20cm



Pelvic Reduction Forceps Asymmetric
10-1353 40cm



Malleolar Bone Holding Forceps
10-1354 21cm
Straight, 1 x 1 teeth



Patella Malleolar Forceps
10-1355 21cm



10-1356 16cm
10-1357 24cm

Reduction Forceps with Thread Lock



Reposition Forceps
10-1358 23cm



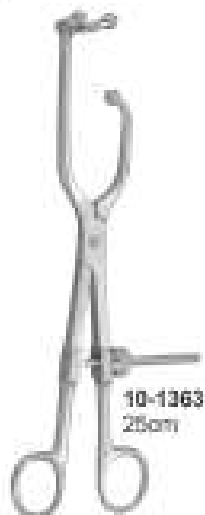
Pelvic Reposition Forceps
10-1359 19cm
10-1360 23cm



Pelvic Reposition Forceps
10-1361 25cm



Pelvic Reposition Forceps with 3 Ball Spikes
10-1362 25cm



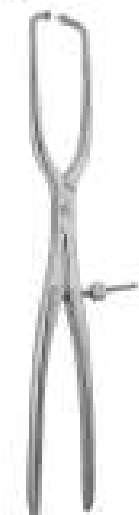
Pelvic Reduction Forceps Asymmetric with 3 ball Spikes
10-1363 25cm



Pelvic Reduction Forceps Asymmetric
10-1364 25cm



Pelvic Reposition Forceps
10-1365 40cm



Pelvic Reposition Forceps
10-1366 40cm

HAND DRILLS

Handhapparate
Perforateurs a main

Perforadores de mano
Perforatori a mano



Bunnell Drill
10-1367 16cm
Opening up to 4mm
10-1368 spare key
light metal housing
longitudinally cannulated



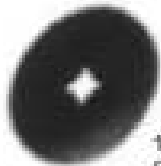
Raik Drill
10-1369 16cm
Opening up to 6.35mm
light metal housing
longitudinally cannulated



10-1372



Plaster Saw Electronic Power
Volt #110
10-1370



10-1373
Spare Blade

Volt #220
10-1371



Moore Drill And Bit Set Complete
10-1374



Fig. 1 10-1376 2.5mm
Fig. 2 10-1377 3.0mm
Fig. 3 10-1378 3.5mm
Fig. 4 10-1379 4.0mm
Fig. 5 10-1380 5.0mm
Fig. 6 10-1381 8.0mm
Fig. 7 10-1382 12.0mm
Fig. 8 10-1383 16.0mm
Fig. 09 10-1384
Fig. 10 10-1385 1.0mm
Fig. 11 10-1386 1.5mm
Fig. 12 10-1387 2.0mm

Stille Pattern Drill Set
10-1375
Complete set of stainless
drill bits and burs

HAND DRILLS



Handbohrapparate
Perforateurs a main

Perforadores de mano
Perforatori a mano



10-1388
Hudson Brace 26.7cm
with standard thumb screw chuck

10-1389
Hudson Brace 27.9cm
with Improved Snap-Lock chuck

- C 10-1390 Hudson Bur, 9mm Diameter
- D 10-1391 Hudson Bur, 14mm Diameter
- E 10-1392 Hudson Bur, 16mm Diameter
- F 10-1393 Hudson Bur, 22mm Diameter
- G 10-1394 Cushing Perforator, for Hudson Brace
- H 10-1395 Hudson Cerabellar Extension, 4" for Hudson Brace
- I 10-1396 McKenzie Perforator for Hudson Brace



Jacobs
10-1397 28cm
opening up to 6.35mm



Hand Drill
10-1398
opening up to 6.35mm



T-Handle
10-1399
AO Coupling



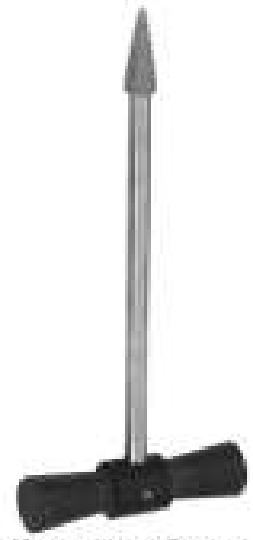
Jacob's Chuck
10-1400 T-Handle and key
10-1401 only
10-1402 Key



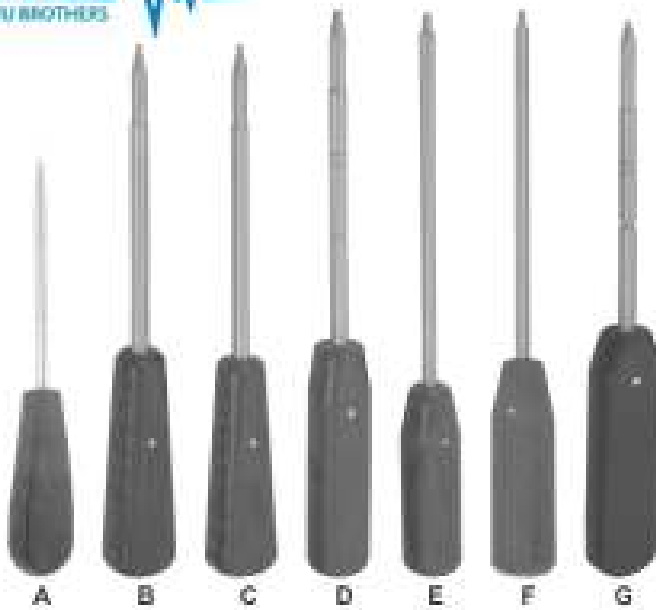
Key Handle
10-1403



T-Handle
10-1404
for AO Coupling



Memoral Head Extractor
10-1405



HEXAGONAL HEAD

	Size of screws	Head Size	Fiber-Handle	AO Coupling	Dental Coupling
A	1.5mm	1.5mm	10-1406	10-1409	10-1412
B	2.0mm				
C	2.7mm	2.5mm	10-1407	10-1410	
D	3.5mm				
E	4.0mm				
F	4.5mm	3.5mm	10-1408	10-1411	
G	6.5mm				



Parallel Target Device
10-1413
for guide wires 2mm

Mortising Chisel
10-1414

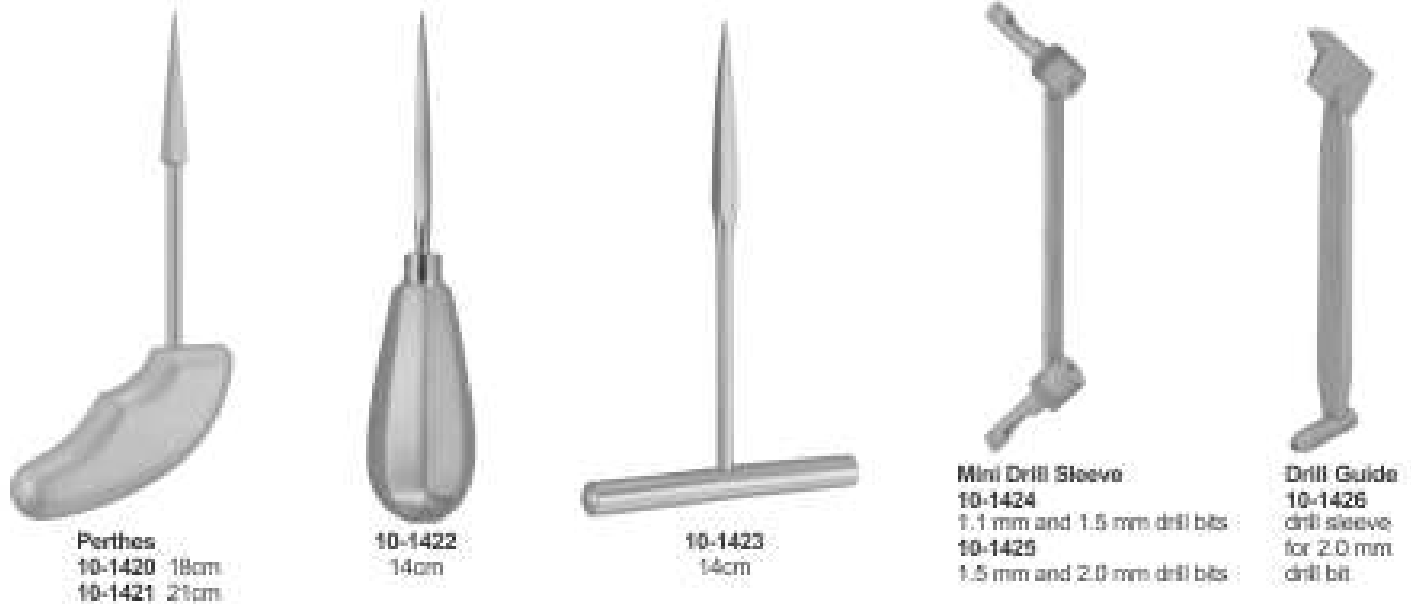
Wire Guide
10-1415
45mm

Wire Guide
10-1416
70mm

Countersink
10-1417

Countersink
10-1418

Countersink
10-1419



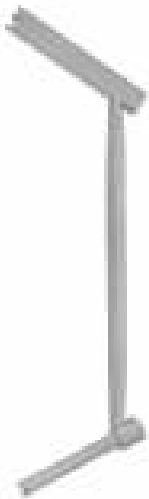
Perthes
10-1420 18cm
10-1421 21cm

10-1422
14cm

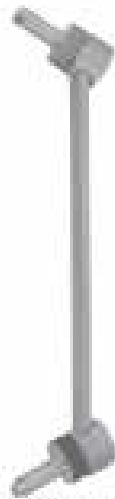
10-1423
14cm

Mini Drill Sleeve
10-1424
1.1 mm and 1.5 mm drill bits
10-1425
1.5 mm and 2.0 mm drill bits

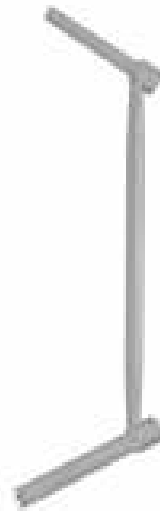
Drill Guide
10-1426
drill sleeve for 2.0 mm drill bit



10-1427 Tap Sleeve, 2.0 mm ø
10-1428 Drill Sleeve, 2.7 mm ø
10-1429 Tap Sleeve, 2.5 mm ø
10-1430 Drill Sleeve, 3.5 mm ø



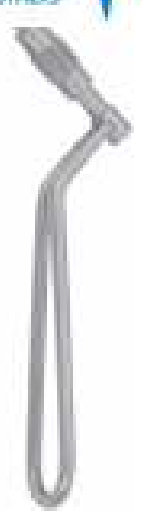
Neutral & Load Drill Guide
10-1431 1.5 mm for 2.0 mm Screws
10-1432 2.0 mm for 2.7 mm Screws
10-1433 2.5 mm for 3.5 mm Screws
10-1434 3.2 mm for 4.5 mm Screws



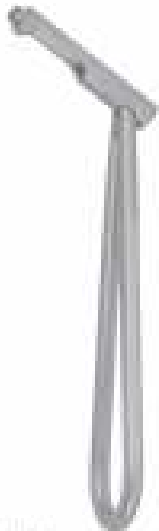
Tap Sleeve
10-1435
 3.5 mm



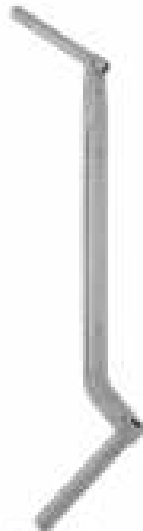
Tap Sleeve
10-1436
 3.5 mm also for used
 as 3.2 mm drill Guide



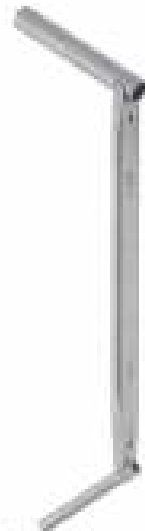
Tap Sleeve
10-1437
 4.5 mm



Drill Sleeve
10-1438 3.2 mm
 for Round Hole Plates



Drill Guide
10-1439 4.5 mm Screws
 Drill Bit 4.5 mm & 3.2 mm



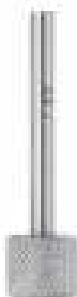
Drill Guide
10-1440 6.5 mm Screws
 Drill Bit 3.2 mm



Drill Guide
10-1441 3.5 mm for neutral and
 compression Positioning Drill Bit 2.5 mm



C-Clamp
10-1442
 Drill Guide with thread
 for Drill Bit 4.5 mm



Insert Drill Sleeve
10-1443 2.7 / 2.0 mm Drill Bit 2.0 mm
10-1444 3.5 / 2.5 mm Drill Bit 2.5 mm
10-1445 4.5 / 3.2 mm Drill Bit 3.2 mm



Drill Small Pointed
10-1446 Drill Bit 3.5 mm



Drill Pointed Guide
10-1447 6.5 mm



Drill Pointed Guide
10-1448 6.5 mm



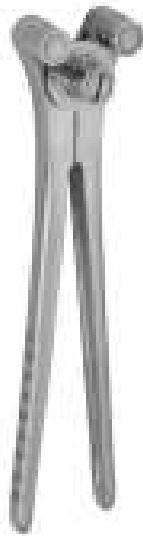
**Bending Device
10-1449
21.5cm**
to bend straight
and angled plates



**Bending Device
10-1450
21.5cm**
to bend straight
and angled plates



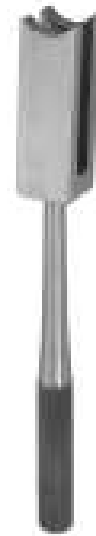
**Rod Bender
10-1451**
to bend straight
and angled



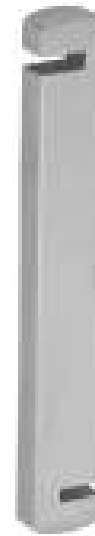
**Universal Rod Bender
10-1452 28.5cm**
to bend straight
and angled



**Rod Bender
10-1453**
to bend straight
and angled



**Slotted Hammer
10-1454 14mm**



**Plate Bender
10-1455**



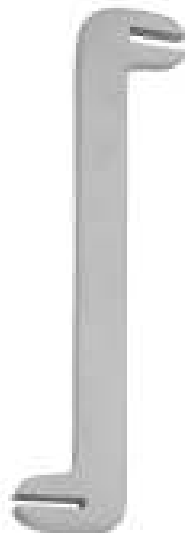
**Plate Bender
10-1456**



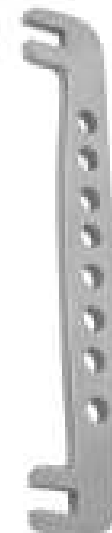
**Plate Bender
10-1457**



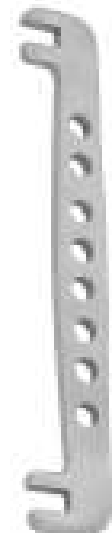
**Plate Bender
10-1458**



**Plate Bender
10-1459**



**Plate Bender
10-1460**



**Plate Bender
10-1461**

EXTENSION BOWS

Extensionsbugel
Etriers pour extension

Estribas para extension
Archi per estensione



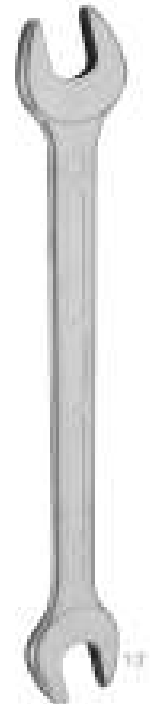
10-1462 18cm
Wire strainer for
Kirschner wires



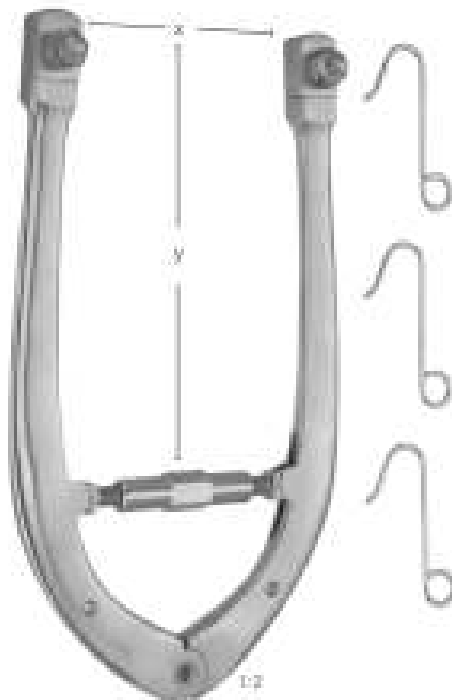
Kirschner Extension Bows
10-1463 $x=95\text{mm}$ $y=70\text{mm}$
10-1464 $x=100\text{mm}$ $y=100\text{mm}$
10-1465 $x=120\text{mm}$ $y=120\text{mm}$
10-1466 $x=155\text{mm}$ $y=155\text{mm}$
10-1467 $x=200\text{mm}$ $y=155\text{mm}$
with 3 traction hooks



Kirschner Extension Bows
10-1468 $x=130\text{mm}$
10-1469 $x=185\text{mm}$
10-1470 $x=220\text{mm}$
with 3 traction hooks



**Wrench
Kirschner
Extension Bows**
10-1471
14mm/17mm



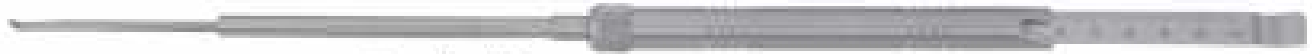
Kirschner Extension Bows
10-1472 $x=180\text{mm}$ $y=100\text{mm}$
10-1473 $x=270\text{mm}$ $y=160\text{mm}$
with 3 traction hooks



Bohler Kirschner Extension Bows
10-1474 $x=75\text{mm}$ $y=90\text{mm}$
10-1475 $x=90\text{mm}$ $y=160\text{mm}$
10-1476 $x=110\text{mm}$ $y=210\text{mm}$
10-1477 $x=150\text{mm}$ $y=250\text{mm}$
with 3 traction hooks



**Charnley-muller
10-1478
Compression Clamp**



Screw Depth Gauges

- 10-1479 Mini Gauge, Longmeasures up to 30mm
- 10-1480 Small Gauge, Longmeasures up to 50mm
- 10-1481 Large Gauge, Longmeasures up to 100mm
- 10-1482 X-Large Gauge, Longmeasures up to 120mm



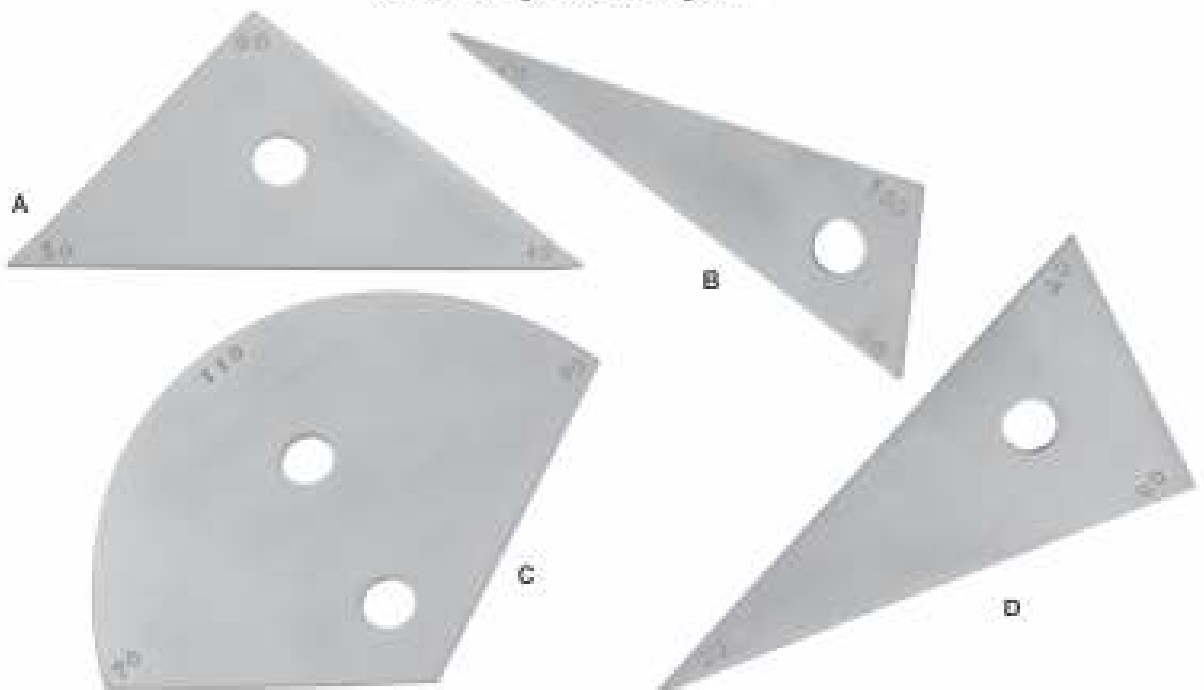
Screw Depth Gauges

- 10-1483 Mini Gauge, Longmeasures up to 30mm
- 10-1484 Small Gauge, Longmeasures up to 50mm
- 10-1485 Large Gauge, Longmeasures up to 100mm
- 10-1486 X-Large Gauge, Longmeasures up to 120mm



**Measuring Gauge
10-1487
for nail**

10-1488 Tri Angular Positioning Plate



NEUROSURGERY INSTRUMENTS





GALT
11-001 Ø 12,5 mm
11-002 Ø 16 mm
11-003 Ø 19 mm

Hubson, Brace Hand Drill
11-004 27cm
complete with 4 twist drills
(Fig. 1 - Fig. 4) and extension piece

Hudson Brace
11-005
28cm with improved
Snap-Lock chuck



Huson Hand
drill bit
Fig.1
11-006
5mm

Huson Hand
drill bit
Fig.2
11-007
14mm

Huson Hand
drill bit
Fig.3
11-008
16mm

Huson Hand
drill bit
Fig.4
11-009
22mm

Cushing
Hand drill bit
11-010
14mm

Hudson
Corabellar
Extension
10cm
11-011
Hudson Brace

McKenzie
Hand drill bit
11-012
13mm

CERVICAL TRACTION TONGS

Schadefhalter

Pinzas de traccion cranial

Pinces de traction Cranienne

Pinze per trazione craniale



Crutchfield
Traction Tongs
11-013 13cm
small

11-015



Crutchfield drill bit 3.5mm
Crutchfield drill bit 5mm

Set of 2 Pieces for
11-013 and 11-014



Crutchfield
Traction Tongs
11-014 18.5cm



11-015
Wrench double-ended for



Crutchfield Skull
11-016
large type, cervical traction tongs -
pins adjustable no drilling to be done
11cm



Cloward Vertebral Cervical
Spreader
11-017



Spinal Distractor
11-018 24cm
45° angle / small style
6mm rods



Spinal Distractor
11-019 25.5cm
small style

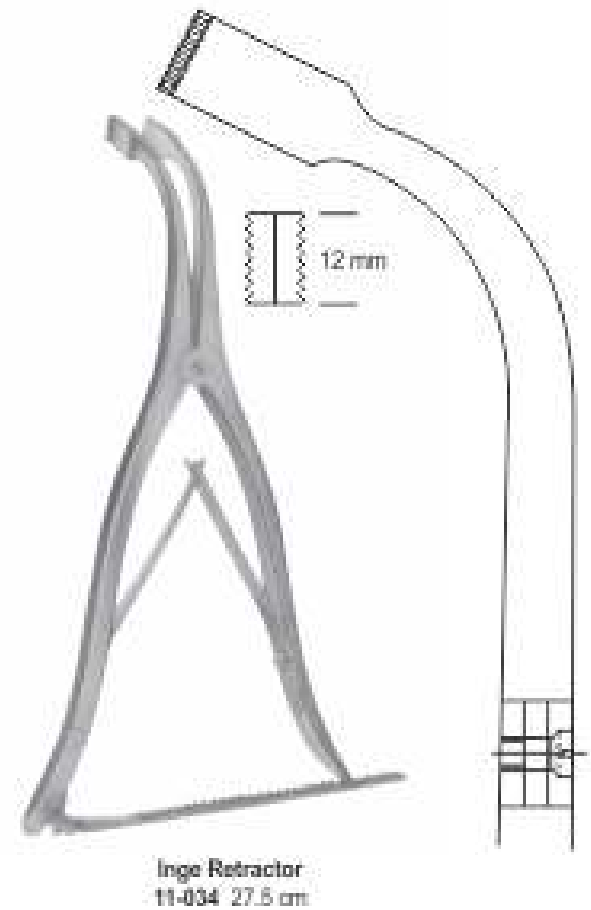
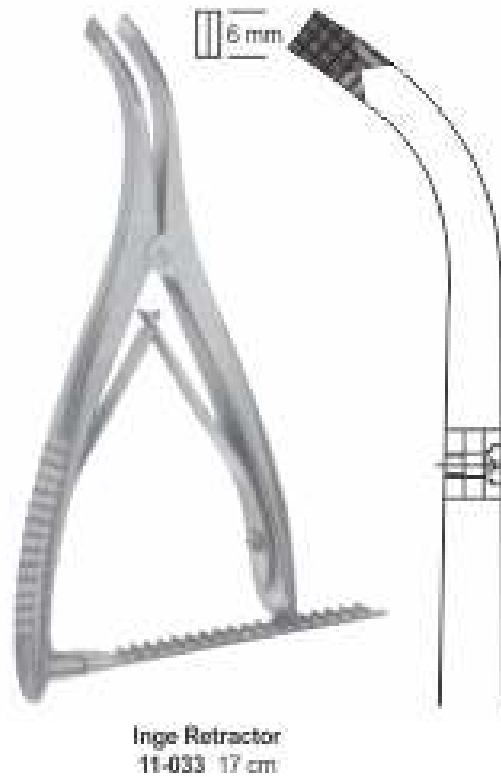
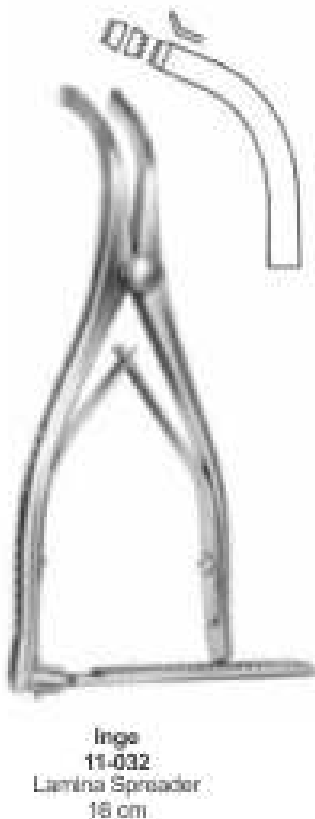
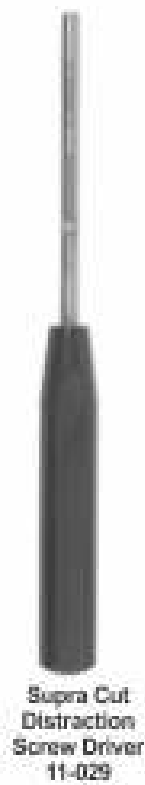


Inge Retractor
11-020 20.5cm
toothed w/spindles



Supra Cut Distraction Screw

- 11-021 12mm Non Sterile
- 11-022 14mm Non Sterile
- 11-023 16mm Non Sterile
- 11-024 18mm Non Sterile
- 11-025 12mm Sterile
- 11-026 14mm Sterile
- 11-027 16mm Sterile
- 11-028 18mm Sterile



INSTRUMENTS FOR CRANIAL OPENING

Instrumente zur Schädelöffnung

Instrumentos para apertura craneana

Instrumentés pour l'ouverture de crâne

Strumenti per l'apertura del cranio



De Martel
Saw Conductor
11-035 33cm



Adson
Dn8 guide
11-036
15cm



De Vibiss
Skull Forceps
11-037
20cm



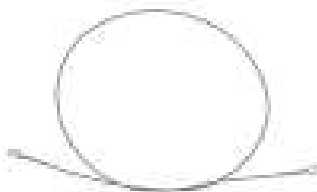
Dahlgren
11-038
Cranial Forceps
20 cm



Gigle-Strully
Handle for
wire saw
11-039



Olivecrona
Wire Saw
11-040 30cm
11-041 40cm
11-042 50cm
11-043 60cm
11-044 70cm



Gigle, Wire Saw
11-045 30cm
11-046 40cm
11-047 50cm
6 wires twisted



Bailey-Gigli
11-048
Saw Guide 30.5cm
flexible



Davis
11-049
Guide for Gigli Saws,
20cm

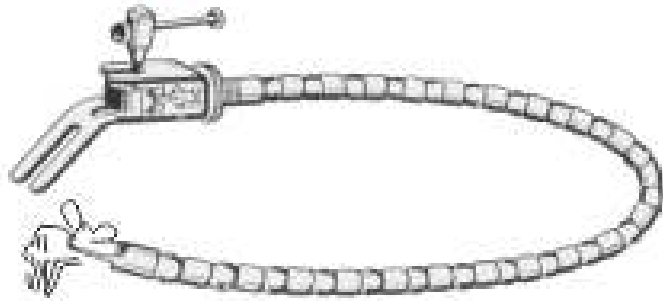


Michele Trephine,
11-050 16cm shaft, 0.47cm
O.D graduated 0.64cm To 3.2cm
11-051 16cm shaft, 0.79cm
O.D graduated 0.64cm To 3.2cm
11-052 16cm shaft, 0.56cm
O.D graduated 0.64cm To 3.2cm

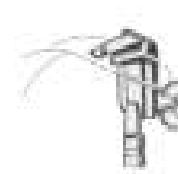
11-050

11-051

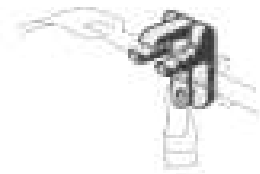
11-052



11-053
wire cable only



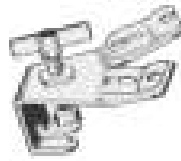
11-054
Support only,
flat brain spatulas.



11-055
Support only,
for brain spatulas
with round shaft
up to 5.5 mm diam.
Fixing for flexible



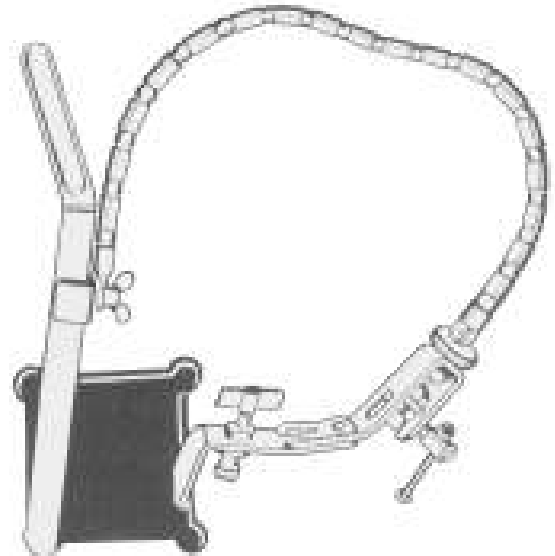
Riichert
11-056
Fixation base, for skull
mounting, holding 1
flexible arms



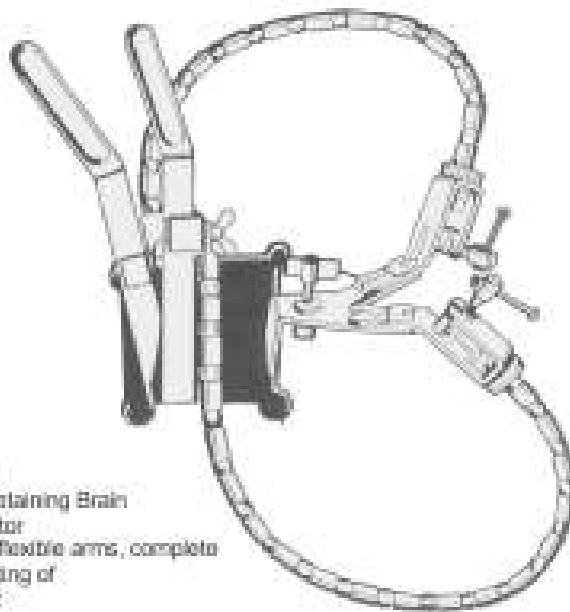
Riichert
11-057
Fixation base, for skull
mounting, holding 2
flexible arms



11-058
Fixation base, for skull
mounting, holding 1
flexible arms



Leyla
Self-Retaining Brain Retractor
with 1 flexible arm, complete consisting of
11-059
11-060
11-051

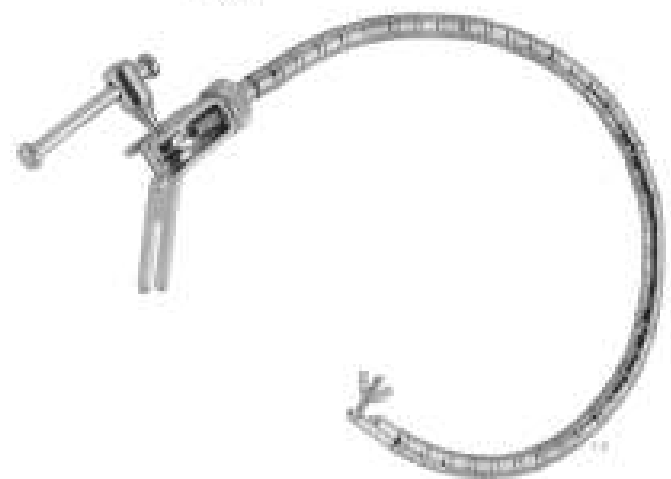


Leyla
Self-Retaining Brain Retractor
with 2 flexible arms, complete
consisting of
11-062
11-063
11-064



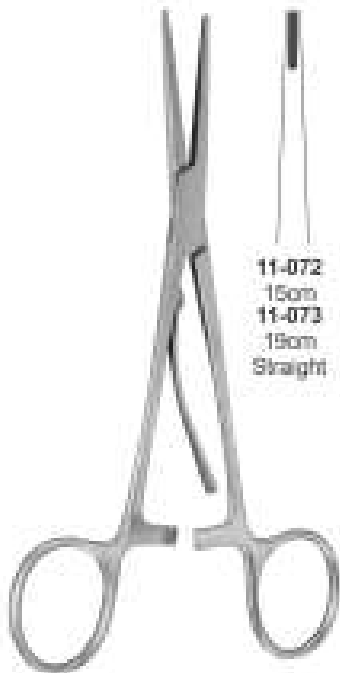
11-065
Fixation base only
holding 2 flexible arms
11-066
Support only for flat
brain spatulas

11-067
Fixation base only
holding 1 flexible arms
11-068
Support only for brain spatulas with round shaft of
4mm and 5mm to fix on the flexible arm
11-069
Flexible arm only for attaching
coupling heads and for fixation bases



11-070
Brain retractor self retaining, with 1 flexible arm,
complete consisting of fixation base for 1 flexible
arm flexible arm only support for flat brain spatulas

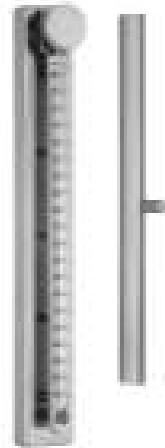
11-071
Brain retractor self retaining, with 2 flexible arm,
complete consisting of fixation base for 2 flexible
arm flexible arm only support for flat brain spatulas



McKenzie Clip Applying Forceps

11-072
15cm
11-073
15cm
Straight

11-074
15cm
11-075
15cm
Curved



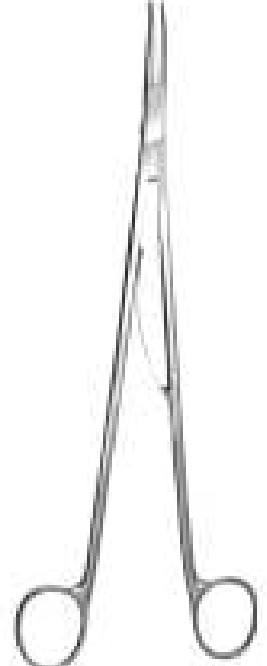
McKenzie 11-076
148mm x 40mm x 6mm
Brain clip rack for 20 clips



McKenzie Clip Applying Forceps 11-077
Straight Handle, Curved Jaws, 15cm



McKenzie Clip Applying Forceps 11-078
Curved Handle, Curved Jaws, 15cm



Smithwick Clip Applying Forceps 11-079 23 cm
11-080 28.5 cm
Curved Jaws
Straight Handle



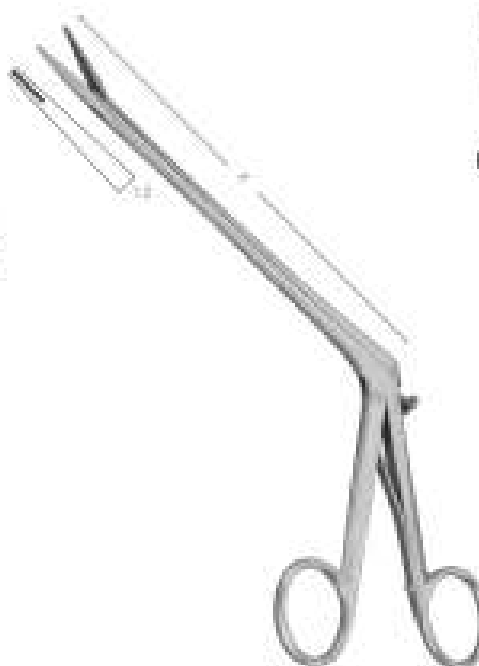
Schwartz Clip Applying Forceps 11-081 20cm
Schwartz Vessel Clip

11-082
2.5cm Straight Jaws 1.7x 8mm

11-083
2.5cm Slightly Angled Jaws 1.7x 8mm



11-084
2.5cm Strong Angled Jaws 1.7x 8mm



Olivecrona Toennis (Scoville) Clip Forceps 11-085 14cm



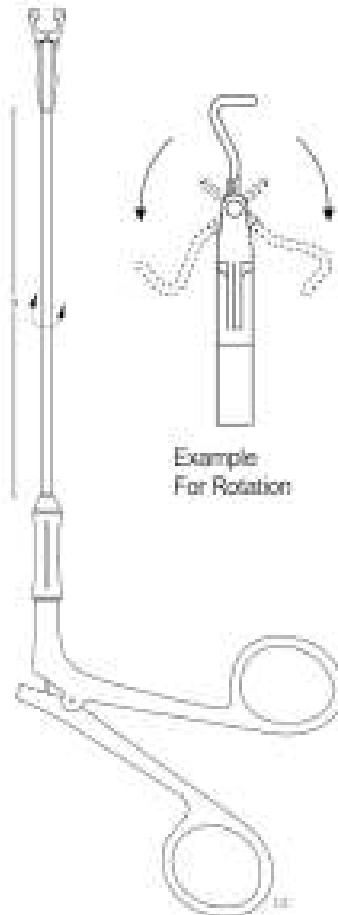
11-087
Raney Hemostasis Clip



11-088
Koller Scalp Clip



Raney Applying & Removing Forceps 11-086 15cm



Example
For Rotation

Applying Forceps

Mini

- 11-088 7cm
- 11-090 9cm
- 11-091 11cm
- 11-092 13cm

non rotating

Standard

- 11-093 7cm
 - 11-094 9cm
 - 11-095 11cm
 - 11-096 13cm
- non rotating

Mini

- 11-097 7cm
- 11-098 9cm
- 11-099 11cm
- 11-100 13cm

rotating

Standard

- 11-101 7cm
 - 11-102 9cm
 - 11-103 11cm
 - 11-104 13cm
- rotating



Applying Forceps

Mini

- 11-105 18cm
- Straight with ratchet

Standard

- 11-106 18cm
- Straight with ratchet

Mini

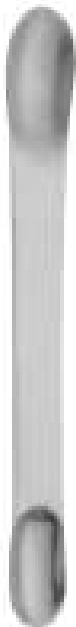
- 11-107 17cm
- 11-108 21cm
- 11-109 23cm

bayonet shaped, with ratchet

Standard

- 11-110 17cm
- 11-111 21cm
- 11-112 23cm

bayonet shaped, with ratchet



Cushing, brain spatula
11-113 7mm x 9mm
11-114 11mm x 13mm
11-115 15mm x 18mm
11-116 18mm x 22mm
18cm



Olivecrona
11-117
brain spatula
18cm



Brain Spatula
11-118 7mm x 9mm
11-119 11mm x 13mm
11-120 15mm x 18mm
11-121 18mm x 22mm
18cm Convex



Brain Spatula
11-122 7mm x 9mm
11-123 11mm x 13mm
11-124 15mm x 18mm
11-125 18mm x 22mm
18cm Concave



Hoffetz, brain spatula
11-126 8mm
11-127 11mm
11-128 14mm
11-129 17mm
11-130 20mm
20cm Malleable

Hirnspatel

Espatulas cerebrales

Spatules cerebrales

Spatale cerebrali

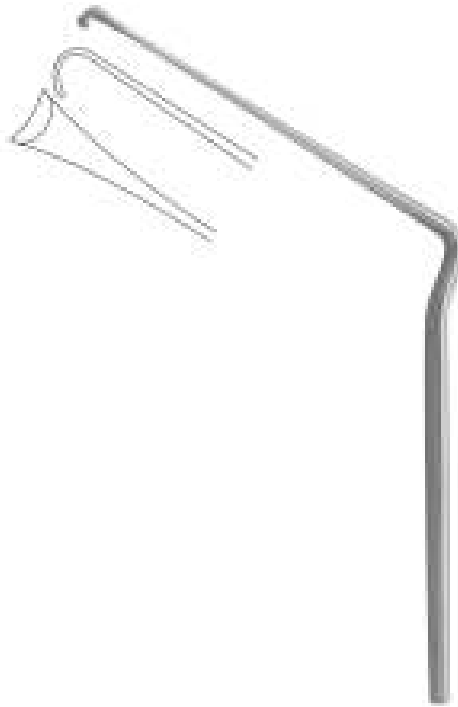
NERVE HOOKS



**Scoville, Nerve
Root Retractor**
11-131 23cm
8mm



**Holsher Nerve
Root Retractor**
11-132 24cm
7mm



**Martin Nerve
Root Retractor**
11-133 21cm
7mm



**Toennis Nerve
Dura Hook**



**Halle Nerve
Dura Hook**
11-136 20cm



**Smithwick Nerve
Dura Hook**
11-137 17cm
11-138 21cm



**Hoen Nerve
Dura Hook**
11-139 22cm



**Cushing Nerve
Dura Hook**

11-140
19cm
11-141
28cm

11-142
19cm
11-143
28cm



**Olivecrona
11-144
Dura Dissector**
18 cm



**Olivecrona
11-145
Dura Dissector**
20 cm



**Milligan
11-146
Dura Dissector**
21.5 cm



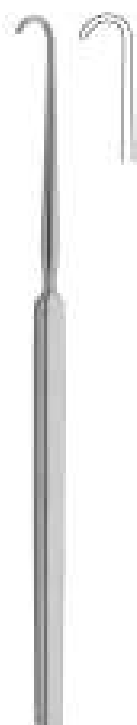
**Davis
11-147
Dura Dissector sharp**
21.5 cm

Nervenhooken - Durahaken

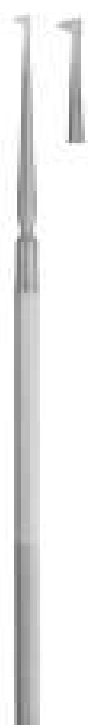
Crochets a nerfs - Crochets pour duremers

Ganchos para nervios - Ganchos para duramadre

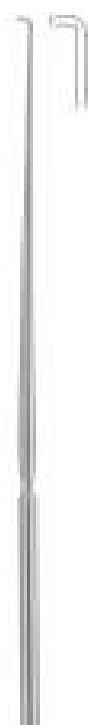
Uncini per nervi - Uncini per duramadre



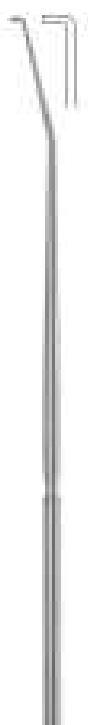
Graham Nerve
Dura Hook
11-148
18.5cm



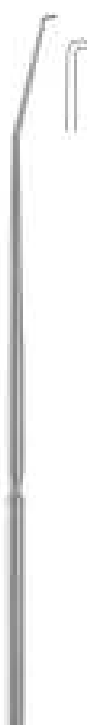
Frazier Nerve
Dura Hook
11-149
17cm



Dandy Nerve
Dura Hook
11-150
20cm



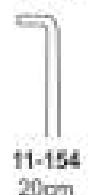
Dandy Nerve
Dura Hook
11-151
20cm



Dandy Nerve
Dura Hook
11-152
20cm

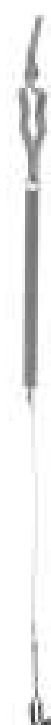


Adson Nerve
Dura Hook



11-153
20cm

11-154
20cm



Yasargil Nerve Dura
Hook Retractor
11-155 21cm
11-156 41cm
Galea retractor



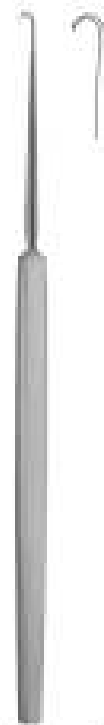
Love Nerve Dura
Hook Retractor
11-157 19cm
Straight



Love Nerve Dura
Hook Retractor
11-158 15cm
45° Angled



Love Nerve Dura
Hook Retractor
11-159
19cm
90° Angled



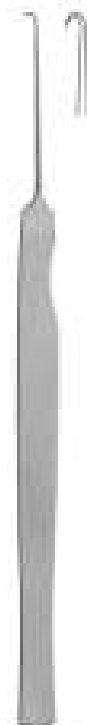
Cushing Nerve Dura
Hook Retractor
11-160 14cm



Frazier Nerve Dura
Hook Retractor



11-161
13cm
11-162
18cm
Blunt



Lahey Nerve Dura
Hook Retractor
11-163
13cm

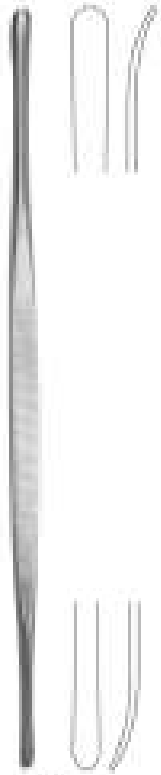
DURA DISSECTORS

Dura-Dissektoren

Disectores de duramadre

Decalfeurs duremiere

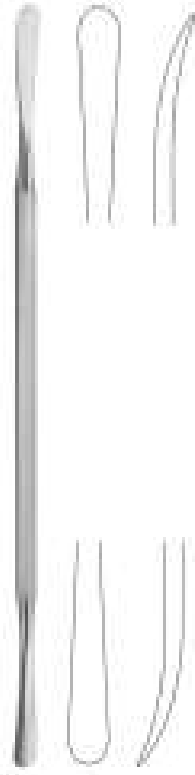
Dissetori per duramadre



Toennis Dura Dissector
11-164
25cm



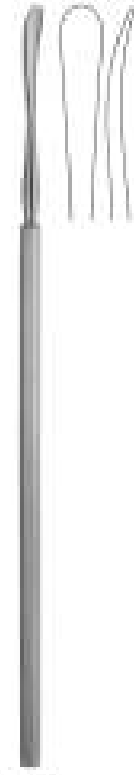
Davis Dura Dissector
11-165
24.5cm



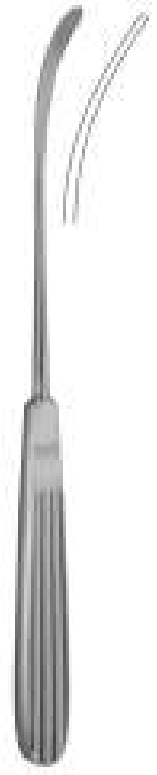
Dura Dissector
11-166 22cm



Sachs Dura Dissector
11-167 21cm



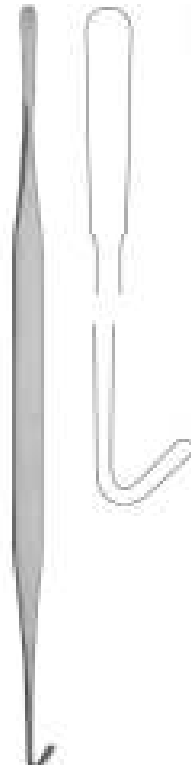
Sachs Dura Dissector
11-168 21cm



Sachs Dura Dissector
11-169
21cm



Horsley Dura Dissector
11-170
20cm



Smithwich Dura Dissector
11-171
30.5cm



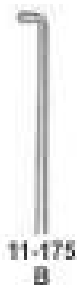
Groningen
11-172
Nerve Hook
26.5 cm.



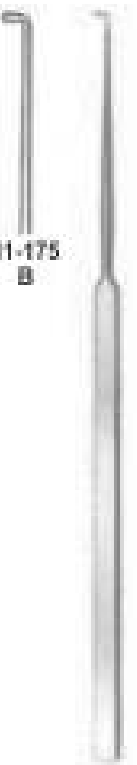
Groningen
11-173
Nerve Hook
26.5 cm.



11-174
A



11-175
B



Cushing
Nerve Hook blunt
19 cm.

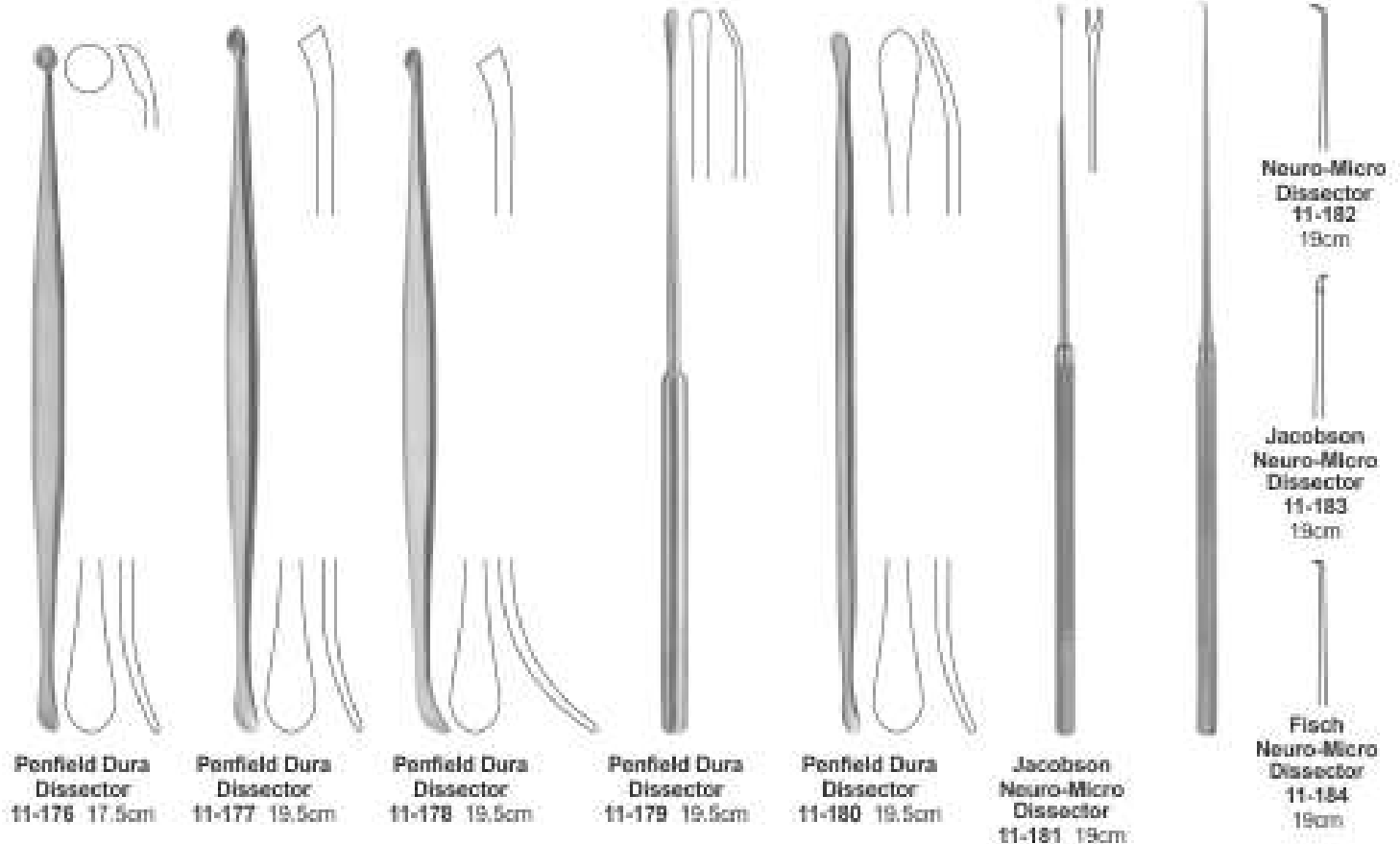
DURA DISSECTORS

Dura-Dissektoren

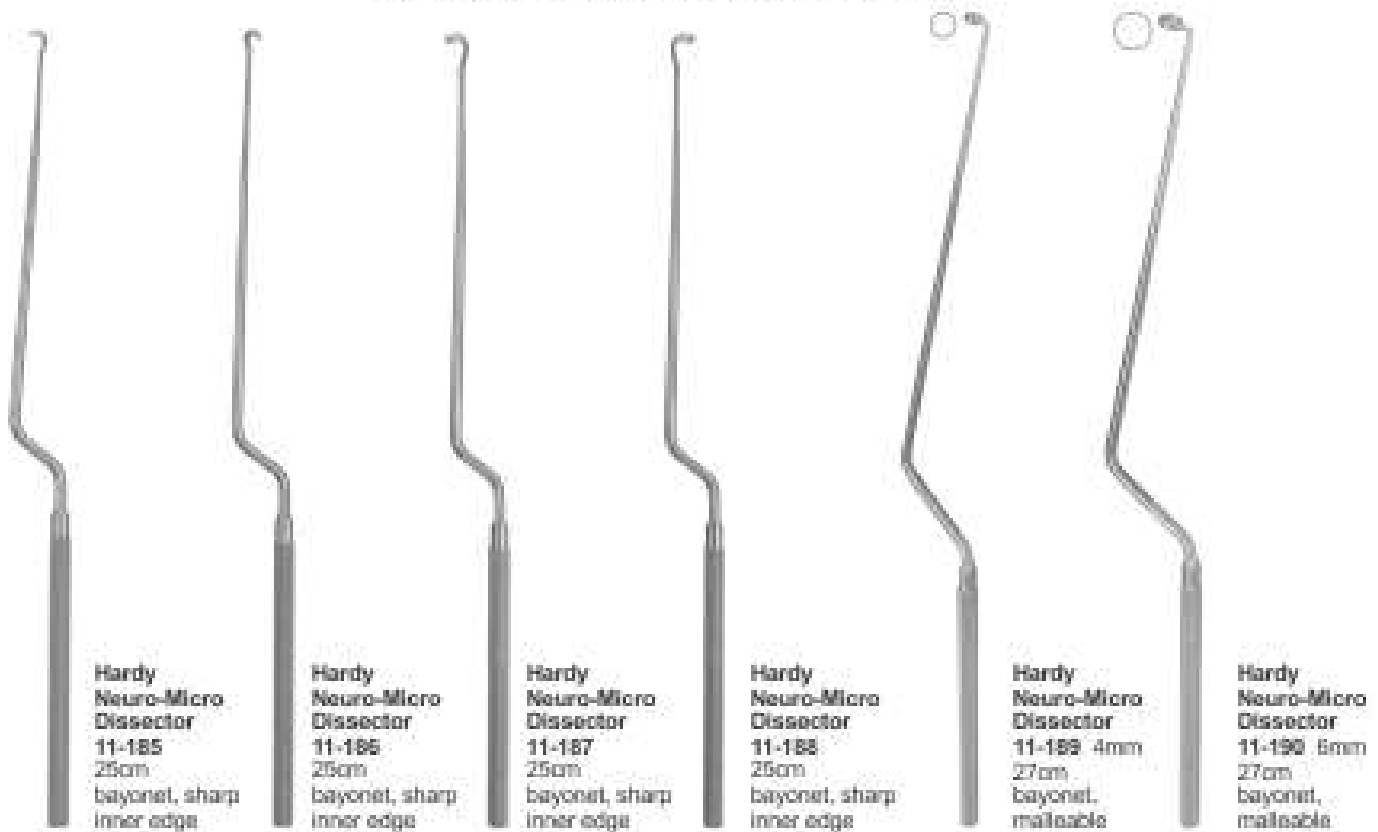
Dissectores de duramadre

Decalfeurs duremère

Dissetori per duramadre



NEURO-DISSECTORS AND CURETTES



NEURO-MICRO DISSECTORS



Neuro-Mikro-Dissektoren
Neuro-micro dissecteurs

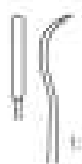
Disectores para micro-neurocirugia
Strumento per micro-neuro chirurgia



Yasargil Neuro-Micro Dissector



11-191
19cm
Straight
11-192
19cm
bayonet



11-193
19cm
Straight
11-194
19cm
bayonet



11-195
19cm
Straight
11-196
19cm
bayonet



11-197
19cm
Straight
11-198
19cm
bayonet



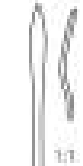
11-199
19cm
Straight
11-200
19cm
bayonet



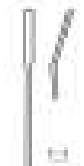
11-201
19cm
Straight
11-202
19cm
bayonet



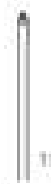
11-203
19cm
Straight
11-204
19cm
bayonet



11-205
19cm
Straight
11-206
19cm
bayonet



11-207
19cm
Straight
11-208
19cm
bayonet



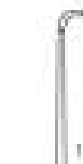
11-209
19cm
Straight, with
Twist-fixationhook



11-210
19cm
Straight, with
Twist-fixationhook



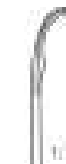
Kraus
11-211
19cm
bayonet



Yasargil
11-212
19cm
bayonet



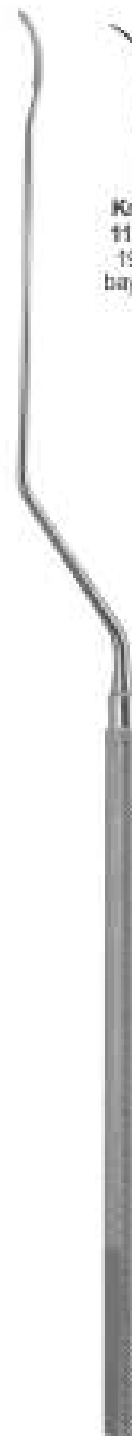
Koos
11-213
19cm
bayonet



Koos
11-214
19cm
bayonet



Koos
11-215
19cm
bayonet



Neuro-Micro Dissector

Laminektomiestenzen

Pinces emporte-pieces a laminectomie

Pinzas cortantes para laminectomia

Pinze taglianti per laminectomia



Cushing Intervertebral Disc Rongeurs

2 X 10mm, 15cm
11-216 straight
11-217 UP
11-218 Down

1.5 X 10mm, 15cm
11-219 straight
11-220 Up
11-221 Down

2 X 10mm, 18cm
11-222 straight
11-223 UP
11-224 Down

1.5 X 10mm, 23cm
11-225 straight
11-226 Up
11-227 Down

2 X 10mm, 23cm
11-228 straight
11-229 UP
11-230 Down

2 X 10mm, 25.5cm
11-231 straight
11-232 UP
11-233 Down

2 X 10mm, 28cm
11-234 straight
11-235 UP
11-236 Down

2 X 10mm, 30.5cm
11-237 straight
11-238 UP
11-239 Down



Lova-Gruenwald Intervertebral Disc Rongeurs

3 X 10mm, 15cm
11-240 straight
11-241 Up
11-242 Down

3 X 10mm, 18cm
11-243 straight
11-244 Up
11-245 Down

3 X 10mm, 23cm
11-246 straight
11-247 Up
11-248 Down

3 X 10mm, 25.5cm
11-249 straight
11-250 Up
11-251 Down

3 X 10mm, 28cm
11-252 straight
11-253 Up
11-254 Down

3 X 10mm, 30.5cm
11-255 straight
11-256 Up
11-257 Down



Spurling Intervertebral Disc Rongeurs

4 X 10mm, 15cm
11-258 straight
11-259 Up
11-260 Down

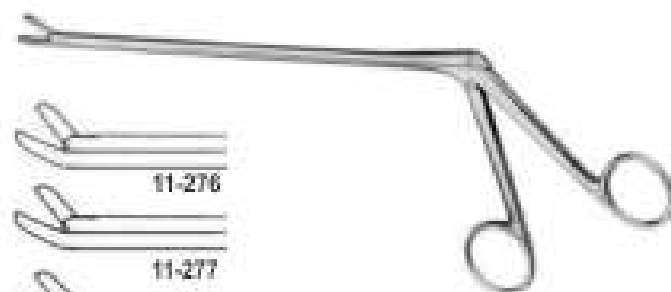
4 X 10mm, 18cm
11-261 straight
11-262 Up
11-263 Down

4 X 10mm, 23cm
11-264 straight
11-265 Up
11-266 Down

4 X 10mm, 25.5cm
11-267 straight
11-268 Up
11-269 Down

4 X 10mm, 28cm
11-270 straight
11-271 Up
11-272 Down

4 X 10mm, 30.5cm
11-273 straight
11-274 Up
11-275 Down



- 11-276
- 11-277
- 11-278
- 11-279
- 11-280

Cushing

Laminectomy Rongeur jaw 2 x 10 to 4 x 10 mm straight shaft length 150 mm



- 11-281
- 11-282
- 11-283
- 11-284
- 11-285

Cushing

Laminectomy Rongeur jaw 2 x 10 to 4 x 10 mm upwards 45 degree

Laminectomiestanzen

Pinces emporte-pièces a laminectomie

Pinzas cortantes para laminectomia

Pinze taglianti per laminectomia



Wide Intervertebral Disc Rongeurs

18cm Straight
11-286 2.5mm
11-287 3mm
11-288 4mm
11-289 5mm

18cm Angled up
11-290 2.5mm
11-291 3mm
11-292 4mm
11-293 5mm

23.5cm Straight
11-294 3mm
11-295 4mm
11-296 5mm



Caspas Type Intervertebral Disc Rongeurs

16cm Straight
11-297 2 x 12mm
11-298 3 x 12mm
11-299 4 x 14mm
11-300 5 x 14mm
11-301 6 x 16mm

16cm Up
11-302 3 x 12mm
11-303 4 x 14mm
11-304 5 x 14mm

16cm Down
11-305 3 x 12mm
11-306 4 x 14mm



Caspas Type Intervertebral Disc Rongeurs

18.5cm Straight
11-307 2 x 12mm
11-308 3 x 12mm
11-309 4 x 14mm
11-310 5 x 14mm
11-311 6 x 16mm

18.5cm Up
11-312 2 x 12mm
11-313 3 x 12mm
11-314 4 x 14mm
11-315 5 x 14mm

18.5cm Down
11-316 2 x 12mm
11-317 3 x 12mm
11-318 4 x 14mm



Cushing Intervertebral Disc Rongeurs

width 2 x 10mm, 18cm
11-319 Straight
11-320 Up
11-321 Down

L-G Intervertebral Disc Rongeurs

width 3 x 10mm, 18cm
11-322 Straight
11-323 Up
11-324 Down

3 x 10mm, 25.5cm
11-325 Straight



Schlesinger Intervertebral Disc Rongeurs

11-326 2 x 10mm, 13cm Straight
11-327 3 x 10mm, 13cm Straight
11-328 4 x 10mm, 13cm Straight
11-329 3 x 10mm, 13cm Angled Up



Cloward Intervertebral Disc Rongeurs

width 6 x 10mm, 13cm
11-330 Straight
11-331 Up
11-332 Down



Oldberg Intervertebral Disc Rongeurs

11-333 5mm Diameter
18.5cm



Selverstone Intervertebral Disc Rongeurs

11-334 2 x 3mm, 15cm
11-335 2 x 5mm, 15cm



Cushing Intervertebral Disc Rongeurs

2 X 10mm, 13cm
11-336 Straight
11-337 UP
11-338 Down

Love-Gruenwald Intervertebral Disc Rongeurs

3 X 10mm, 13cm
11-339 Straight
11-340 Up
11-341 Down

Spurling Intervertebral Disc Rongeurs

4 X 10mm, 13cm
11-342 Straight
11-343 Up
11-344 Down

Laminektomiestanzen

Pinces emporte-pieces a laminectomie

Pinzas cortantes para laminectomia

Pinze taglianti per laminectomia



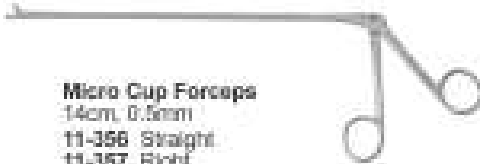
Decker Intervertebral Disc Rongeurs
2 x 5mm, 15cm
11-345 Right
11-346 Left
11-347 Down
11-348 Up
11-349 Straight



Jackson Intervertebral Disc Rongeurs
70° Up 18cm
11-350 2 x 8mm
11-351 3 x 8mm
11-352 4 x 8mm



Williams Style Micro Disc Intervertebral Disc Rongeurs
1 x 2 teeth, Straight
11-353 14cm
11-354 18cm
11-355 25.5cm



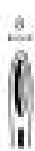
Micro Cup Forceps
14cm, 0.5mm
11-358 Straight
11-357 Right
11-358 Left



Micro Cup Forceps
14cm 1mm
11-359 Straight
11-360 Right
11-361 Left
14cm 2mm
11-362 Straight



Micro Cup Forceps
20.5cm, 2mm
11-363 Straight
11-364 Up
11-365 Down



Well Blakesley Laminectomy rongeurs



12cm
Straight

Fig. 1
3.0mm
11-366

Fig. 2
3.5mm
11-367

Fig. 3
4.5mm
11-368

Fig. 4
5.0mm
11-369

Fig. 5
5.5mm
11-370



12cm
45° up

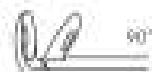
11-371

11-372

11-373

11-374

11-375



12cm
90° up

11-376

11-377

11-378



18cm
45° up

Fig. 1
3.0mm
11-379

Fig. 2
3.5mm
11-380

Fig. 3
4.5mm
11-381

Fig. 4
5.0mm
11-382

Fig. 5
5.5mm
11-383



18cm 7"
90° up

11-384

11-385

11-386

11-387

Laminectomiestanzan

Pinzas cortantes para laminectomía

Pinzas emporte-pièces a laminectomie

Pinze taglienti per laminectomia

Ferris Smith Micro Kerrison Laminectomy Rongeurs

45° UP 9mm bite opening, 18cm

- 11-388 1mm
- 11-389 2mm
- 11-390 3mm
- 11-391 4mm
- 11-392 5mm
- 11-393 6mm

50° UP 9mm bite opening, 20.5cm

- 11-394 1mm
- 11-395 2mm
- 11-396 3mm
- 11-397 4mm
- 11-398 5mm
- 11-399 6mm



Ferris Smith Micro Kerrison Laminectomy Rongeurs

45° Down 9mm bite opening, 19cm

- 11-400 1mm
- 11-401 2mm
- 11-402 3mm
- 11-403 4mm
- 11-404 5mm
- 11-405 6mm

50° Down 9mm bite opening, 20.5cm

- 11-406 1mm
- 11-407 2mm
- 11-408 3mm
- 11-409 4mm
- 11-410 5mm
- 11-411 6mm



Ferris Smith Micro Kerrison Laminectomy Rongeurs UPWARD

40° UP

9mm bite opening, 18cm

- 11-412 1mm
- 11-413 2mm
- 11-414 3mm
- 11-415 4mm
- 11-416 5mm
- 11-417 6mm

40° UP

9mm bite opening, 23cm

- 11-435 1mm
- 11-436 2mm
- 11-437 3mm
- 11-438 4mm
- 11-439 5mm
- 11-440 6mm

40° Down

9mm bite opening, 18cm

- 11-418 2mm
- 11-419 3mm
- 11-420 4mm
- 11-421 5mm
- 11-422 6mm

40° UP

9mm bite opening, 25.5cm

- 11-441 2mm
- 11-442 3mm
- 11-443 4mm
- 11-444 5mm
- 11-445 6mm

40° UP

9mm bite opening, 20.5cm

- 11-423 1mm
- 11-424 2mm
- 11-425 3mm
- 11-426 4mm
- 11-427 5mm
- 11-428 6mm

40° UP

9mm bite opening,

- 11-446 2mm
- 11-447 3mm
- 11-448 4mm
- 11-449 5mm
- 11-450 6mm

40° Down

9mm bite opening, 20.5cm

- 11-429 1mm
- 11-430 2mm
- 11-431 3mm
- 11-432 4mm
- 11-433 5mm
- 11-434 6mm

40° UP

9mm bite opening, 30.5cm

- 11-451 2mm
- 11-452 3mm
- 11-453 4mm
- 11-454 5mm
- 11-455 6mm



Ferris Smith Micro Kerrison Laminectomy Rongeurs DOWNWARD

130° Down

9mm bite opening, 18cm

- 11-456 1mm
- 11-457 2mm
- 11-458 3mm
- 11-459 4mm
- 11-460 5mm
- 11-461 6mm

130° Down

9mm bite opening, 28cm

- 11-480 1mm
- 11-481 2mm
- 11-482 3mm
- 11-483 4mm
- 11-484 5mm
- 11-485 6mm

130° Down

9mm bite opening, 20.5cm

- 11-462 1mm
- 11-463 2mm
- 11-464 3mm
- 11-465 4mm
- 11-466 5mm
- 11-467 6mm

130° Down

9mm bite opening, 30.5cm

- 11-486 1mm
- 11-487 2mm
- 11-488 3mm
- 11-489 4mm
- 11-490 5mm
- 11-491 6mm

130° Down

9mm bite opening, 23cm

- 11-468 1mm
- 11-469 2mm
- 11-470 3mm
- 11-471 4mm
- 11-472 5mm
- 11-473 6mm

130° Down

9mm bite opening, 25.5cm

- 11-474 1mm
- 11-475 2mm
- 11-476 3mm
- 11-477 4mm
- 11-478 5mm
- 11-479 6mm

Laminektomiestanzen

Pinzas cortantes para laminectomia

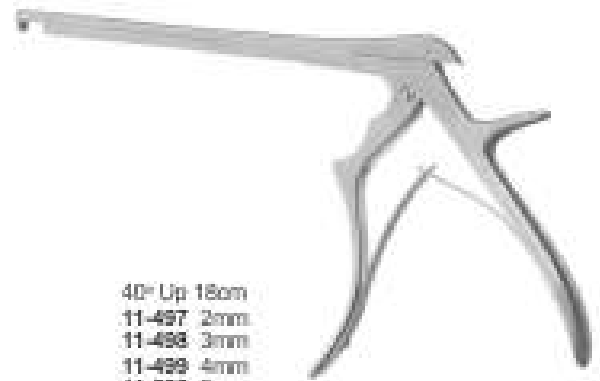
Pinces emporte-pièces a laminectomie

Pinze taglianti per laminectomia



**Micro Ejector Kerrison
Laminectomy Rongeurs**

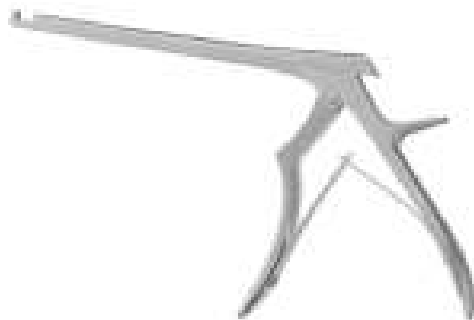
40° Up 20.5cm
11-492 2mm
11-493 3mm
11-494 4mm
11-495 5mm
11-496 6mm



**Wide Mouth Ejector Kerrison
Laminectomy Rongeurs**

40° Up 18cm
11-497 2mm
11-498 3mm
11-499 4mm
11-500 5mm
11-501 6mm

40° Up 20.5cm
11-502 2mm
11-503 3mm
11-504 4mm
11-505 5mm
11-506 6mm

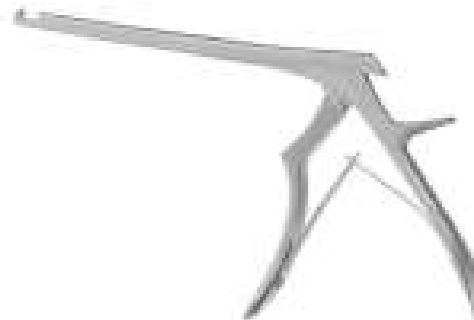


**Spurling Kerrison
Laminectomy Rongeurs
Large Handle**

40° UP,
15mm Bite Opening, 18cm
11-507 2mm
11-508 3mm
11-509 4mm
11-510 5mm
11-511 6mm

40° UP,
15mm Bite Opening, 20.5cm
11-512 2mm
11-513 3mm
11-514 4mm
11-515 5mm
11-516 6mm

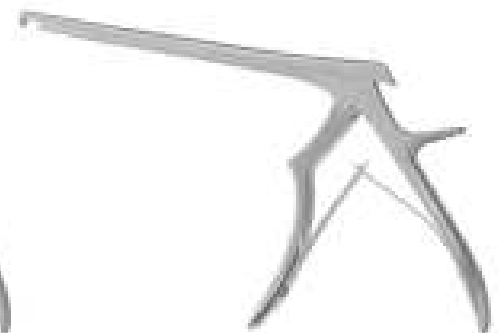
40° UP,
15mm Bite Opening, 23cm
11-517 2mm
11-518 3mm
11-519 4mm
11-520 5mm
11-521 6mm



**Spurling Kerrison
Laminectomy Rongeurs
Large Handle**

40° UP,
15mm Bite Opening, 25.5cm
11-522 2mm
11-523 3mm
11-524 4mm
11-525 5mm
11-526 6mm

40° UP,
15mm Bite Opening, 28cm
11-527 2mm
11-528 3mm
11-529 4mm
11-530 5mm
11-531 6mm



**Spurling Kerrison
Laminectomy Rongeurs
Large Handle**

90° Down,
15mm Bite Opening, 18cm
11-542 2mm
11-543 3mm
11-544 4mm
11-545 5mm
11-546 6mm

90° Down,
15mm Bite Opening, 20.5cm
11-547 2mm
11-548 3mm
11-549 4mm
11-550 5mm
11-551 6mm

LAMINECTOMY PUNCHES

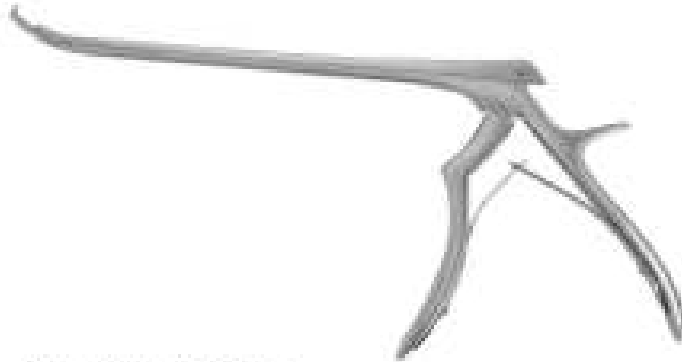


Laminectomiestanzen

Pinzas cortantes para laminectomía

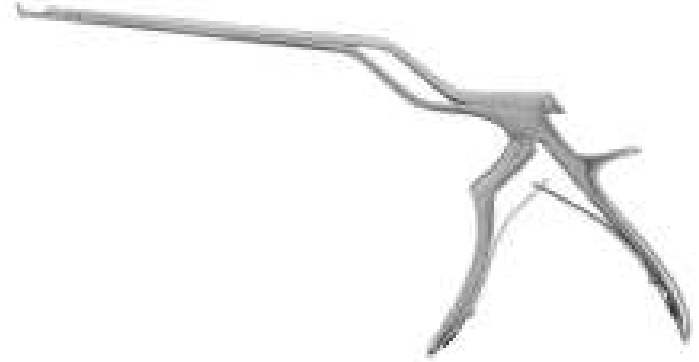
Pinces emporte-pièces a laminectomie

Pinze taglianti per laminectomia



Foramenotomy Kerrison Laminectomy Rongeurs, Curved

- 11-552 UP, 9mm Bite opening, 20.5cm 2mm
- 11-553 UP, 9mm Bite opening, 20.5cm 3mm
- 11-554 UP, 9mm Bite opening, 20.5cm 4mm
- 11-555 UP, 9mm Bite opening, 20.5cm 5mm
- 11-556 UP, 9mm Bite opening, 20.5cm 6mm
- 11-557 Left, 9mm Bite opening, 20.5cm 6mm
- 11-558 Right, 9mm Bite opening, 20.5cm 6mm



Bayonet Micro Kerrison Laminectomy Rongeurs

- 40° Up, 150 mm Working Length 20.5cm
- 11-559 1mm
- 11-560 2mm
- 11-561 3mm
- 11-562 4mm
- 11-563 5mm
- 11-564 6mm

- 90° Up, 150 mm Working Length 20.5cm
- 11-565 1mm
- 11-566 2mm
- 11-567 3mm
- 11-568 4mm
- 11-569 5mm
- 11-570 6mm

Bayonet Spurling Kerrison Laminectomy Rongeurs

- 40° Up, 150 mm Working Length 20.5cm
- 11-571 1mm
- 11-572 2mm
- 11-573 3mm
- 11-574 4mm
- 11-575 5mm
- 11-576 6mm

- 90° Up, 150 mm Working Length 20.5cm
- 11-577 1mm
- 11-578 2mm
- 11-579 3mm
- 11-580 4mm
- 11-581 5mm
- 11-582 6mm



Spurling Laminectomy Rongeurs

- 40° UP, 15mm Bite Opening, 18cm
- 11-583 2mm
- 11-584 3mm
- 11-585 4mm
- 11-586 5mm
- 11-587 6mm

- 40° UP, 15mm Bite Opening, 23cm
- 11-593 2mm
- 11-594 3mm
- 11-595 4mm
- 11-596 5mm
- 11-597 6mm

- 40° UP, 15mm Bite Opening, 20.5cm
- 11-588 2mm
- 11-589 3mm
- 11-590 4mm
- 11-591 5mm
- 11-592 6mm

- 40° UP, 15mm Bite Opening, 25.5cm
- 11-598 2mm
- 11-599 3mm
- 11-600 4mm
- 11-601 5mm
- 11-602 6mm

- 40° UP, 15mm Bite Opening, 28cm
- 11-603 2mm
- 11-604 3mm
- 11-605 4mm
- 11-606 5mm
- 11-607 6mm

Laminektomiesterenzi

Pinzas cortantes para laminectomia

Pinces emporte-pieces a laminectomia

Pinze taglianti per laminectomia

90° UP, 15mm Bite Opening, 18cm

- 11-608 2mm
- 11-609 3mm
- 11-610 4mm
- 11-611 5mm
- 11-612 6mm



Spurling Laminectomy Rongeurs

90° UP, 15mm Bite Opening, 20.5cm

- 11-613 2mm
- 11-614 3mm
- 11-615 4mm
- 11-616 5mm
- 11-617 6mm

90° Down, 15mm Bite Opening, 18cm

- 11-618 2mm
- 11-619 3mm
- 11-620 4mm
- 11-621 5mm
- 11-622 6mm



Spurling Laminectomy Rongeurs

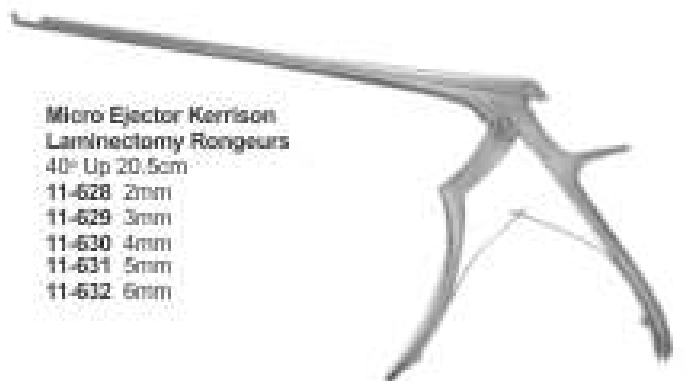
90° Down, 15mm Bite Opening, 20.5cm

- 11-623 2mm
- 11-624 3mm
- 11-625 4mm
- 11-626 5mm
- 11-627 6mm

Micro Ejector Kerrison
Laminectomy Rongeurs

40° Up 20.5cm

- 11-628 2mm
- 11-629 3mm
- 11-630 4mm
- 11-631 5mm
- 11-632 6mm



Wide Mouth Ejector Kerrison
Laminectomy Rongeurs

40° Up 18cm

- 11-633 2mm
- 11-634 3mm
- 11-635 4mm
- 11-636 5mm
- 11-637 6mm

40° Up 20.5cm

- 11-638 2mm
- 11-639 3mm
- 11-640 4mm
- 11-641 5mm
- 11-642 6mm



Ferris Smith Micro Kerrison
Laminectomy Rongeurs

130° Down Bite, 25cm

- 11-643 4mm
- 11-644 5mm
- 11-645 6mm



130° Down Bite, 30.5cm

- 11-646 1mm
- 11-647 2mm
- 11-648 3mm
- 11-649 4mm
- 11-650 5mm
- 11-651 6mm

Spurling Intervertebral
Disc Rongeurs

w/teeth 4 x 10mm, 18cm

- 11-652 Straight
- 11-653 Up
- 11-654 Down

4 x 10mm, 25.5cm

- 11-655 Straight

5 x 10mm, 25.5cm

- 11-656 Straight



Kerrison Cervical Rongeur

11-657

17.8 cm shaft, 3 mm
40 degree forward angle



Schlesinger Cervical Rongeur

11-658

thin tips, 15 cm shaft, up-bite, 3 mm



Laminectomiestanzan

Pinzas cortantes para laminectomia

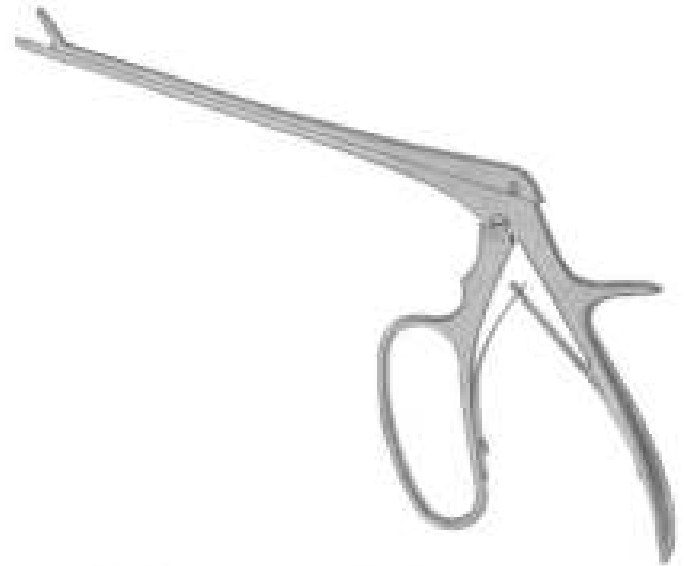
Pinces emporte-pieces a laminectomie

Pinze taglianti per laminectomia



Ferris-Smith Intervertebral Disc Rongeurs

- 18cm straight
 11-659 2 x 10mm
 11-660 3 x 10mm
 11-661 4 x 8mm
 11-662 4 x 10mm
 11-663 6 x 10mm
 11-664 6 x 12mm



Ferris-Smith Intervertebral Disc Rongeurs

- 18cm Up
 11-665 2 x 10mm
 11-666 3 x 10mm
 11-667 4 x 10mm
 11-668 6 x 10mm

- 18cm Down
 11-669 2 x 10mm
 11-670 3 x 10mm
 11-671 4 x 10mm
 11-672 6 x 10mm



Peapod Intervertebral Disc Rongeurs, 14cm

- 11-673 Angle up 1.5mm, x-small
 11-674 Angle up 2mm, small
 11-675 Angle up 2.5mm, medium
 11-676 Angle up 3mm, large



Peapod Intervertebral Disc Rongeurs,

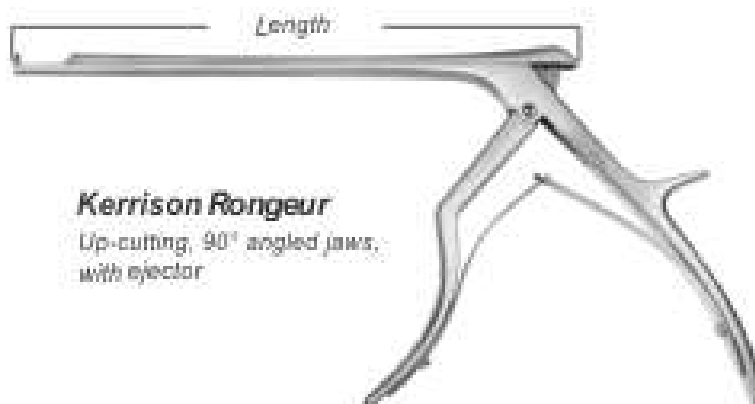
- 11-677 Angle up 2.5mm, 18cm
 11-678 Angle up 3mm, 18cm
 11-679 Angle up 4mm, 18cm
 11-680 Straight 2mm, 14cm
 11-681 Straight 2.5mm, 14cm
 11-682 Straight 3mm, 14cm

Laminektomiestanzen

Pinces emporte-pieces a laminectomie





Pinzas cortantes para laminectomia

Pinze taglienti per laminectomia











Kerrison Rongeur

Up-cutting, 90° angled jaws,
with ejector

Ferris-Smith Kerrison handle	Kerrison Small handle	Kerrison Large handle		Jaw size (width x height)	Length*
					
		11-707		2.0 x 2.0 mm	18 cm
11-683	11-685	11-708		2.5 x 2.5 mm	18 cm
11-684	11-686	11-709		2.0 x 3.0 mm	18 cm
11-685	11-687	11-710		3.0 x 4.0 mm	18 cm
11-686	11-688	11-711		4.0 x 5.0 mm	18 cm
11-687	11-689	11-712		5.0 x 5.0 mm	18 cm
11-688	11-700	11-713		6.0 x 5.0 mm	18 cm
		11-714		7.0 x 6.0 mm	18 cm
		11-715		2.0 x 2.0 mm	20 cm
11-689	11-701	11-716		2.5 x 2.5 mm	20 cm
11-690	11-702			2.0 x 3.0 mm	20 cm
11-691	11-703	11-717		3.0 x 4.0 mm	20 cm
11-692	11-704	11-718		4.0 x 5.0 mm	20 cm
11-693	11-705	11-719		5.0 x 5.0 mm	20 cm
11-694	11-706	11-720		6.0 x 5.0 mm	20 cm
		11-721		7.0 x 6.0 mm	20 cm
		11-722		2.0 x 2.0 mm	22 cm
		11-723		2.5 x 2.5 mm	22 cm
		11-724		2.0 x 3.0 mm	22 cm
		11-725		3.0 x 4.0 mm	22 cm
		11-726		4.0 x 5.0 mm	22 cm
		11-727		5.0 x 5.0 mm	22 cm
		11-728		6.0 x 5.0 mm	22 cm
		11-729		7.0 x 6.0 mm	22 cm
		11-730		2.0 x 2.0 mm	25 cm
		11-731		2.0 x 3.0 mm	25 cm
		11-732		3.0 x 4.0 mm	25 cm
		11-733		4.0 x 5.0 mm	25 cm
		11-734		5.0 x 5.0 mm	25 cm
		11-735		2.0 x 2.0 mm	30 cm
		11-736		3.0 x 4.0 mm	30 cm
		11-737		4.0 x 5.0 mm	30 cm
		11-738		5.0 x 5.0 mm	30 cm

Maulgrößen / Jaw sizes:

-  2.0 x 2.0 mm
-  2.5 x 2.5 mm
-  2.0 x 3.0 mm
-  3.0 x 4.0 mm
-  4.0 x 5.0 mm
-  5.0 x 5.0 mm
-  6.0 x 5.0 mm
-  7.0 x 6.0 mm

* Lengths are measured with closed jaws

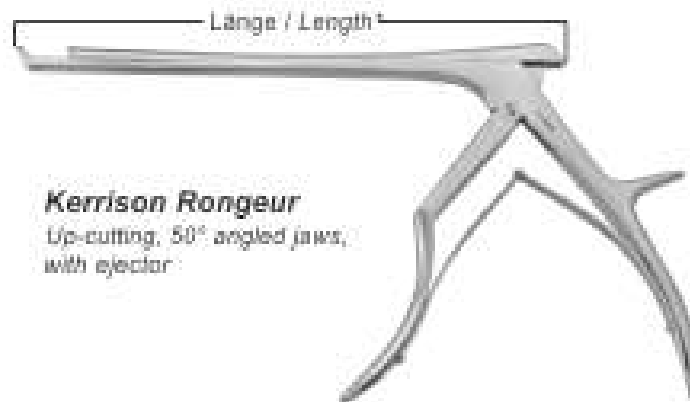
LAMINECTOMY PUNCHES

Laminectomiestanzen

Pinzas cortantes para laminectomía





Pinces emporte-pièces à laminectomie

Pinze taglienti per laminectomia



Kerrison Rongeur

Up-cutting, 50° angled jaws, with ejector

Ferris-Smith Kerrison handle	Kerrison Small handle	Kerrison Large handle	Jaw size (width x height)	Length*
				
		11-763	2.0 x 2.0 mm	18 cm
11-739	11-751	11-764	2.5 x 2.5 mm	18 cm
11-740	11-752		2.0 x 3.0 mm	18 cm
11-741	11-753	11-765	3.0 x 4.0 mm	18 cm
11-742	11-754	11-766	4.0 x 5.0 mm	18 cm
11-743	11-755	11-767	5.0 x 5.0 mm	18 cm
11-744	11-756	11-768	6.0 x 5.0 mm	18 cm
		11-769	7.0 x 6.0 mm	18 cm
		11-770	2.0 x 2.0 mm	20 cm
11-745	11-757	11-771	2.5 x 2.5 mm	20 cm
11-746	11-758	11-772	2.0 x 3.0 mm	20 cm
11-747	11-759	11-773	3.0 x 4.0 mm	20 cm
11-748	11-760	11-774	4.0 x 5.0 mm	20 cm
11-749	11-761	11-775	5.0 x 5.0 mm	20 cm
11-750	11-762	11-776	6.0 x 5.0 mm	20 cm
		11-777	7.0 x 6.0 mm	20 cm
		11-778	2.0 x 2.0 mm	22 cm
		11-779	2.5 x 2.5 mm	22 cm
		11-780	3.0 x 4.0 mm	22 cm
		11-781	4.0 x 5.0 mm	22 cm
		11-782	5.0 x 5.0 mm	22 cm
		11-783	6.0 x 5.0 mm	22 cm
		11-784	7.0 x 6.0 mm	22 cm
		11-785	2.0 x 2.0 mm	25 cm
		11-786	3.0 x 4.0 mm	25 cm
		11-787	4.0 x 5.0 mm	25 cm
		11-788	5.0 x 5.0 mm	25 cm
		11-789	2.0 x 2.0 mm	30 cm
		11-790	3.0 x 4.0 mm	30 cm
		11-791	4.0 x 5.0 mm	30 cm
		11-792	5.0 x 5.0 mm	30 cm

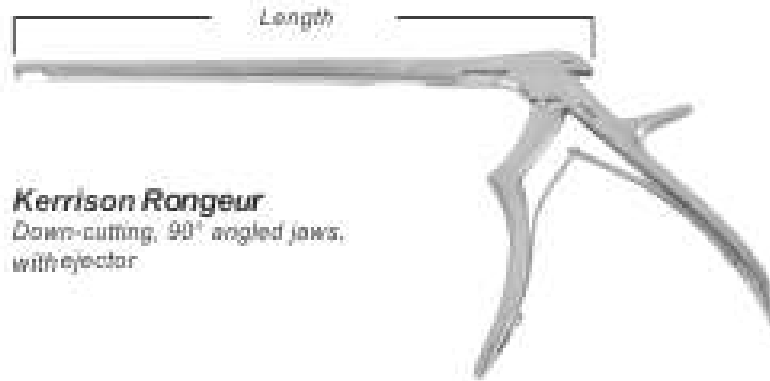
Maulgrößen / Jaw sizes:

-  2.0 x 2.0 mm
-  2.5 x 2.5 mm
-  2.0 x 3.0 mm
-  3.0 x 4.0 mm
-  4.0 x 5.0 mm
-  5.0 x 5.0 mm
-  6.0 x 5.0 mm
-  7.0 x 6.0 mm


* Lengths are measured with closed jaws

Laminektomiestanzen
Pinces emporte-pieces a laminectomie

Pinzas cortantes para laminectomia
Pinze taglienti per laminectomia



Kerrison Rongeur
Down-cutting, 90° angled jaws,
with ejector

Ferris-Smith Kerrison handle	Kerrison Small handle	Kerrison Large handle		
			Jaw size (width x height)	Length*
		11-817	2.0 x 2.0 mm	18 cm
11-793	11-805	11-818	2.5 x 2.5 mm	18 cm
11-794	11-806		2.0 x 3.0 mm	18 cm
11-795	11-807	11-819	3.0 x 4.0 mm	18 cm
11-796	11-808	11-820	4.0 x 5.0 mm	18 cm
11-797	11-809	11-821	5.0 x 5.0 mm	18 cm
11-798	11-810	11-822	6.0 x 5.0 mm	18 cm
		11-823	7.0 x 6.0 mm	18 cm
		11-824	2.0 x 2.0 mm	20 cm
11-799	11-811	11-825	2.5 x 2.5 mm	20 cm
11-800	11-812	11-826	2.0 x 3.0 mm	20 cm
11-801	11-813	11-827	3.0 x 4.0 mm	20 cm
11-802	11-814	11-828	4.0 x 5.0 mm	20 cm
11-803	11-815	11-829	5.0 x 5.0 mm	20 cm
11-804	11-816	11-830	6.0 x 5.0 mm	20 cm
		11-831	7.0 x 6.0 mm	20 cm
		11-832	2.0 x 2.0 mm	22 cm
		11-833	2.5 x 2.5 mm	22 cm
		11-834	2.0 x 3.0 mm	22 cm
		11-835	3.0 x 4.0 mm	22 cm
		11-836	4.0 x 5.0 mm	22 cm
		11-837	5.0 x 5.0 mm	22 cm
		11-838	6.0 x 5.0 mm	22 cm
		11-839	7.0 x 6.0 mm	22 cm
		11-840	2.0 x 2.0 mm	25 cm
		11-841	2.0 x 3.0 mm	25 cm
		11-842	3.0 x 4.0 mm	25 cm
		11-843	4.0 x 5.0 mm	25 cm
		11-844	5.0 x 5.0 mm	25 cm
		11-845	2.0 x 2.0 mm	30 cm
		11-846	2.0 x 3.0 mm	30 cm
		11-847	3.0 x 4.0 mm	30 cm
		11-848	4.0 x 5.0 mm	30 cm
		11-849	5.0 x 5.0 mm	30 cm

Maulgrößen/ Jaw sizes:

-  2.0 x 2.0 mm
-  2.5 x 2.5 mm
-  2.0 x 3.0 mm
-  3.0 x 4.0 mm
-  4.0 x 5.0 mm
-  5.0 x 5.0 mm
-  6.0 x 5.0 mm
-  7.0 x 6.0 mm

* Lengths are measured with closed jaws

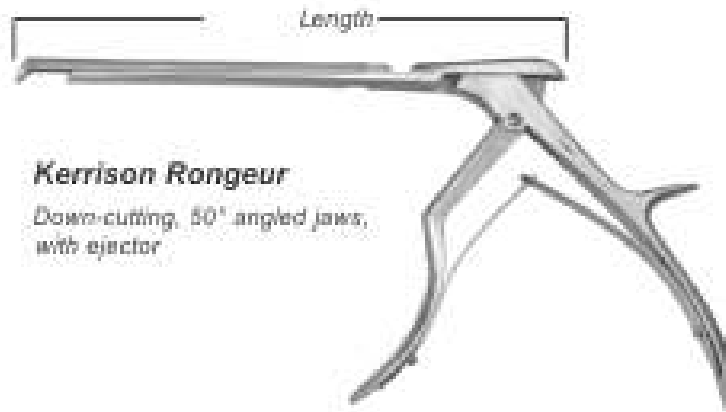
LAMINECTOMY PUNCHES





Laminektomiestanzen

Pinzas cortantes para laminectomia









Pinces emporte-pieces a laminectomie

Pinze taglianti per laminectomia



Ferris-Smith Kerrison handle	Kerrison Small handle	Kerrison Large handle	Jaw size (width x height)	Length*
				
		11-874	2.0 x 2.0 mm	18 cm
11-850	11-862	11-875	2.5 x 2.5 mm	18 cm
11-851	11-863	11-876	2.0 x 3.0 mm	18 cm
11-852	11-864	11-877	3.0 x 4.0 mm	18 cm
11-853	11-865	11-878	4.0 x 5.0 mm	18 cm
11-854	11-866	11-879	5.0 x 5.0 mm	18 cm
11-855	11-867	11-880	6.0 x 5.0 mm	18 cm
		11-881	7.0 x 6.0 mm	18 cm
		11-882	2.0 x 2.0 mm	20 cm
11-856	11-868	11-883	2.5 x 2.5 mm	20 cm
11-857	11-869		2.0 x 3.0 mm	20 cm
11-858	11-870	11-884	3.0 x 4.0 mm	20 cm
11-859	11-871	11-885	4.0 x 5.0 mm	20 cm
11-860	11-872	11-886	5.0 x 5.0 mm	20 cm
11-861	11-873	11-887	6.0 x 5.0 mm	20 cm
		11-888	7.0 x 6.0 mm	20 cm
		11-889	2.0 x 2.0 mm	22 cm
		11-890	2.5 x 2.5 mm	22 cm
		11-891	2.0 x 3.0 mm	22 cm
		11-892	3.0 x 4.0 mm	22 cm
		11-893	4.0 x 5.0 mm	22 cm
		11-894	5.0 x 5.0 mm	22 cm
		11-895	6.0 x 5.0 mm	22 cm
		11-896	7.0 x 6.0 mm	22 cm
		11-897	2.0 x 2.0 mm	25 cm
		11-898	2.0 x 3.0 mm	25 cm
		11-899	3.0 x 4.0 mm	25 cm
		11-900	4.0 x 5.0 mm	25 cm
		11-901	5.0 x 5.0 mm	25 cm
		11-902	2.0 x 2.0 mm	30 cm
		11-903	2.0 x 3.0 mm	30 cm
		11-904	3.0 x 4.0 mm	30 cm
		11-905	4.0 x 5.0 mm	30 cm
		11-906	5.0 x 5.0 mm	30 cm

Maulgrößen Jaw sizes:

-  2.0 x 2.0 mm
-  2.5 x 2.5 mm
-  2.0 x 3.0 mm
-  3.0 x 4.0 mm
-  4.0 x 5.0 mm
-  5.0 x 5.0 mm
-  6.0 x 5.0 mm
-  7.0 x 6.0 mm

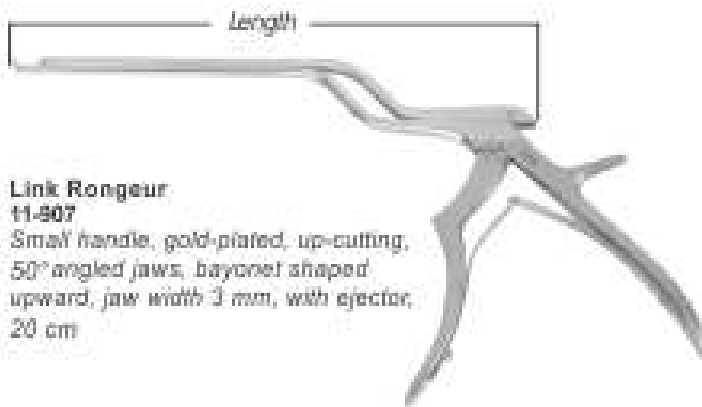
* Lengths are measured with closed jaws

Laminektomiestanzen

Pinces emporte-pieces a laminectomie

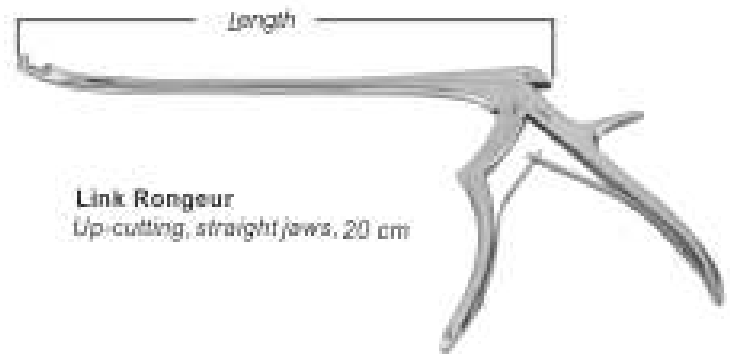
Pinzas cortantes para laminectomia

Pinze taglianti per laminectomia



Link Rongeur
11-907

Small handle, gold-plated, up-cutting, 50° angled jaws, bayonet shaped upward, jaw width 3 mm, with ejector, 20 cm

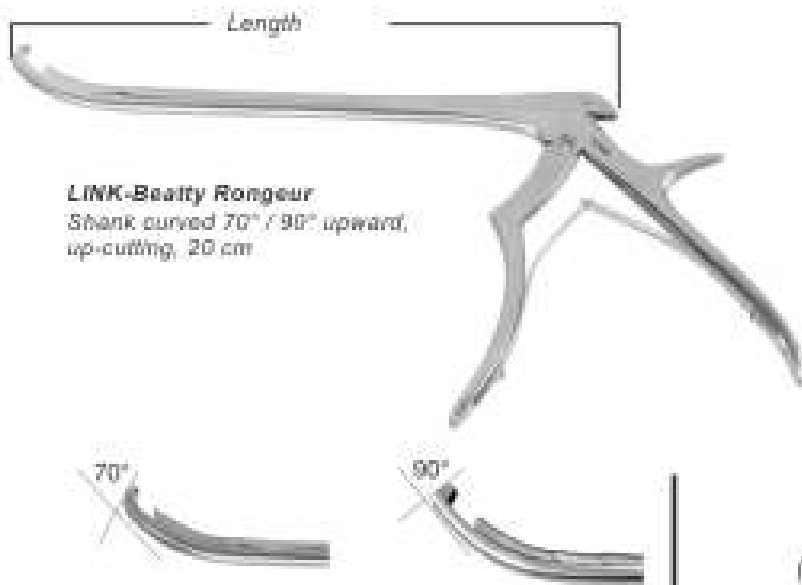


Link Rongeur

Up-cutting, straight jaws, 20 cm

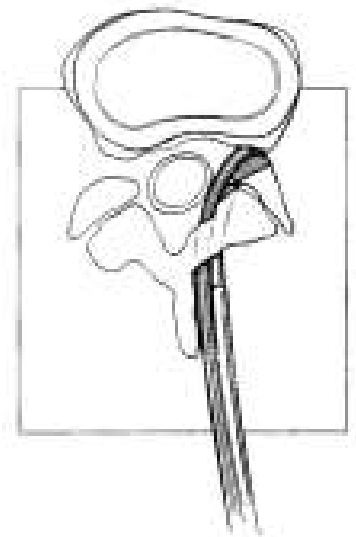
Curved to left	Curved to right	Jaw size (width x height)
		 3,0 x 4,0 mm
11-908	11-911	 4,0 x 4,0 mm
11-909	11-912	 5,0 x 4,0 mm
11-910	11-913	







Lengths are measured with closed jaws



LINK-Beatty Rongeur

Shank curved 70° / 90° upward, up-cutting, 20 cm



		Jaw size (width x height)
		 2,0 x 3,0 mm
11-914	11-918	 3,0 x 4,0 mm
11-915	11-919	 4,0 x 4,0 mm
11-916	11-920	 5,0 x 4,0 mm
11-917	11-921	

Lengths are measured with closed jaws

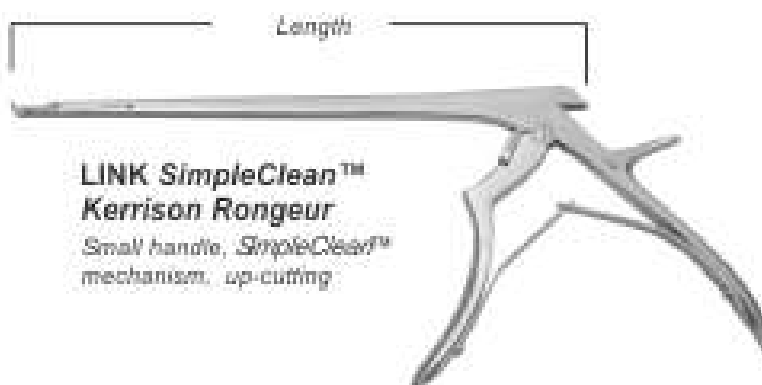
The angled LINK-Beatty Rongeur allows to perform laminotomies while preserving dorsal processes and facet joints.



Laminectomiestanzen

Pinzas cortantes para laminectomia

Pinces emporte-pièces à laminectomie

Pinze taglienti per laminectomia



50° angled jaws thin footplate			50° angled jaws		
	Jaw width	Length*		Jaw width	Length*
11-922	2 mm	18 cm	11-934	2 mm	18 cm
11-923	3 mm	18 cm	11-935	3 mm	18 cm
11-924	4 mm	18 cm	11-936	4 mm	18 cm
11-925	5 mm	18 cm	11-937	5 mm	18 cm
			11-938	6 mm	18 cm
11-926	2 mm	20 cm	11-939	2 mm	20 cm
11-927	3 mm	20 cm	11-940	3 mm	20 cm
11-928	4 mm	20 cm	11-941	4 mm	20 cm
11-929	5 mm	20 cm	11-942	5 mm	20 cm
			11-943	6 mm	20 cm
11-930	2 mm	23 cm	11-944	2 mm	23 cm
11-931	3 mm	23 cm	11-945	3 mm	23 cm
11-932	4 mm	23 cm	11-946	4 mm	23 cm
11-933	5 mm	23 cm	11-947	5 mm	23 cm
			11-948	6 mm	23 cm

Lengths are measured with closed jaws



The SimpleClean™ mechanism makes cleaning of the Rongeurs an easy matter

To open the SimpleClean™ mechanism pull the handle, turn the release and lift up the pusher

The coloured release help to recognize more easily the individual widths of the jaw.

Laminektomiestansen

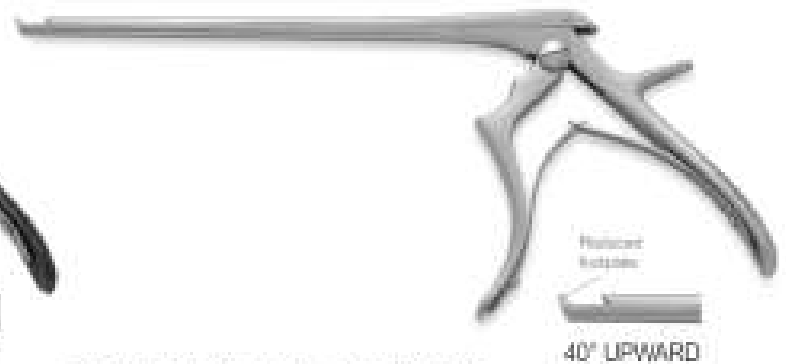
Pinces emporte-pieces a laminectomie

Pinzas cortantes para laminectomia

Pinze taglianti per laminectomia



Black Line® Kerrison Laminectomy Punch
40° UPWARD Jaw angle
with special titanium coating on surface-
Bone ejector



Thin Footplate Kerrison Laminectomy Punch
40° UPWARD Jaw angle
Thin Footplate For cervical surgery

40° UPWARD JAW

18cm/7" Shaft	20cm/8" Shaft	22cm/9" Shaft	Bite Size
11-949	11-955	11-961	1mm
11-950	11-956	11-962	2mm
11-951	11-957	11-963	3mm
11-952	11-958	11-964	4mm
11-953	11-959	11-965	5mm
11-954	11-960	11-966	6mm

40° UPWARD JAW

18cm/7" Shaft	20cm/8" Shaft	Bite Size
11-967	11-972	2mm
11-968	11-973	3mm
11-969	11-974	4mm
11-970	11-975	5mm
11-971	11-976	6mm

A reduced footplate thickness useful for a restricted operating area

40° UPWARD



Ferris-Smith Kerrison Laminectomy Punch
40° UPWARD Jaw angle
Modified ring handle

40° UPWARD JAW

18cm/7" Shaft	20cm/8" Shaft	Bite Size
11-977	11-982	2mm
11-978	11-983	3mm
11-979	11-984	4mm
11-980	11-985	5mm
11-981	11-986	6mm

40° UPWARD



Long Anterior Kerrison Laminectomy Punch
40° UPWARD Jaw angle
with special Titanium coating on surface
Extra long shaft for Thoracic approach
Bone ejector

40° UPWARD JAW

28cm/11" Shaft	Bite Size
11-987	2mm
11-988	3mm
11-989	4mm
11-990	5mm
11-991	6mm

BRAIN RETRACTORS SET

Brain Retractors Set

Conjunto de retractores cerebrales

Ensemble d'écarteurs cérébraux

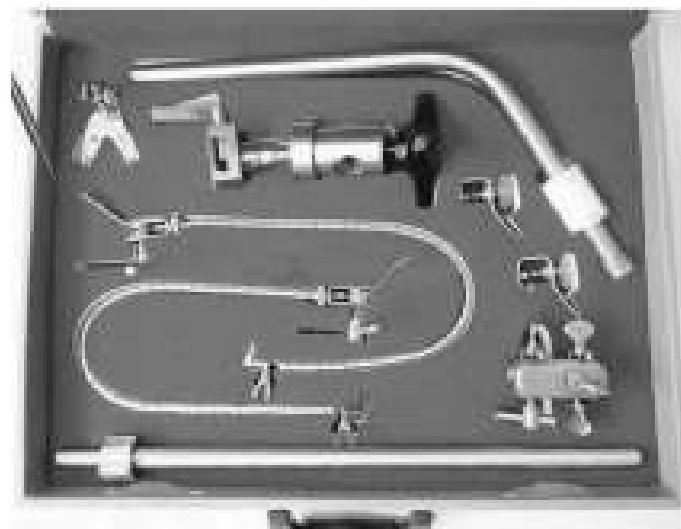
Set di divaricatori per cervello



11-992
Book Walker Retractor
Complete Set with Box



11-993
Book Walker Retractor
Complete Set with Wooden Box



11-994
Leyla
Self-Retaining Brain Retractor

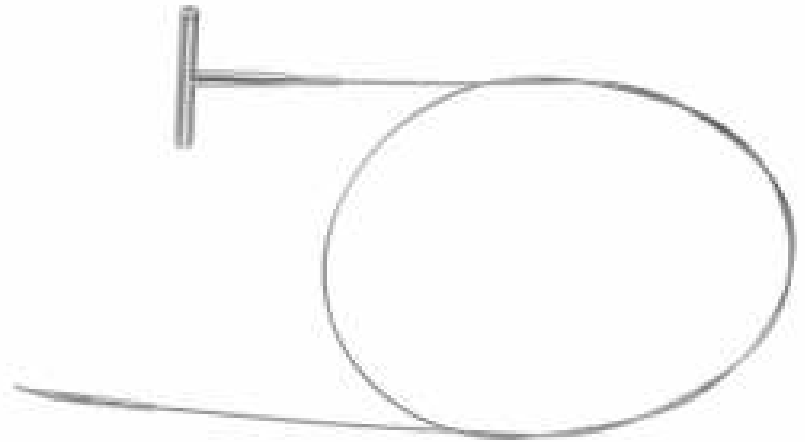
CARDIOVASCULAR & THORACIC INSTRUMENTS



VARICOSE VEIN PROBE SET

Krampfaderbesteck
Trousse a varices

Juego para varices
Astuccio per varici



Nabatoff Varicose Vein Stripper
12-001

135mmx100mmx25mm
complete

- 12-002 Nabatoff Metal Case
- 12-003 Nabatoff Handle
- 12-004 Nabatoff Cable 900mm



3mm

6mm

9mm

12mm

12-005
Nabatoff
Probe tip in plastic



Nabatoff
Metal Probe
12-006
3mm



Nabatoff
Metal Olive
12-007
6mm



Nabatoff
Metal Olive
12-008
9mm



Nabatoff
Metal Olive
12-009
12mm



Nabatoff
Metal Olive
12-010
15mm

Atrauma Mikro-Bulldogklemmen

Micro-Clamps Bulldog à mors Atrauma

Micro-Clamps Bulldog con bocas Atrauma

Atrae i morsetti Micro Bulldog



De Bakay

12-011
7.5 cm



12-012
8.5 cm



12-013
10 cm



12-014
12 cm



De Bakay



12-015
7.5 cm



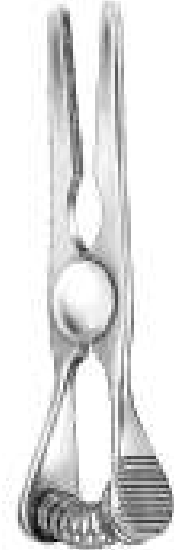
12-016
8.5 cm



12-017
9.5 cm



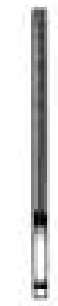
12-018
11 cm



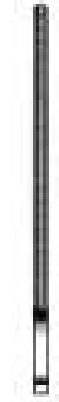
Glover



12-020
7 cm



12-021
8 cm



12-022
9.5 cm



12-023
11 cm



Glover



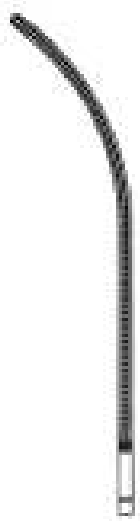
12-024
6.5 cm



12-025
7.5 cm



12-026
9 cm



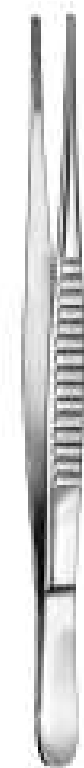
12-027
10.5 cm



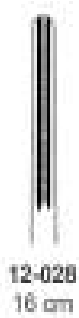
Applying forceps
for bulldog clamps
12-019
24 cm

VASCULAR FORCEPS

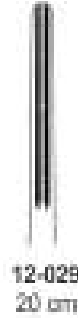
Gefäßklemmen | Pinzas vasculares
Pinces vasculaires | Pinze vascolari



De Bakay
2.7 mm



12-028
16 cm



12-029
20 cm



12-030
25 cm



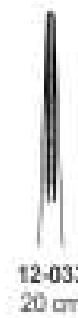
12-031
30 cm



De Bakay
1.5 mm



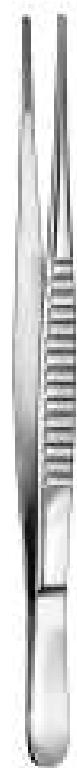
12-032
16 cm



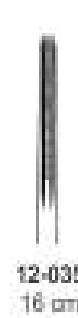
12-033
20 cm



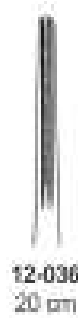
12-034
25 cm



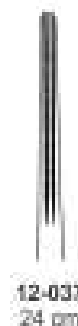
De Bakay
2 mm



12-035
16 cm



12-036
20 cm



12-037
24 cm



12-038
30 cm



De Bakay
2 mm



12-039
16 cm



12-040
19.5 cm



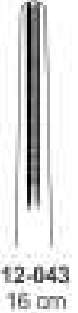
12-041
25 cm



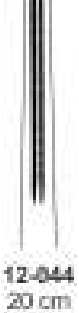
12-042
30 cm



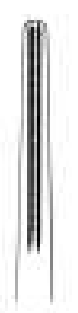
De Bakay
3.5 mm



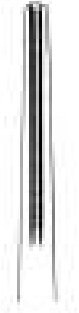
12-043
16 cm



12-044
20 cm



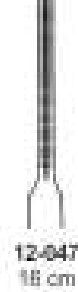
12-045
25 cm



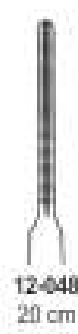
12-046
30 cm



Coolay
2.0 mm



12-047
18 cm



12-048
20 cm

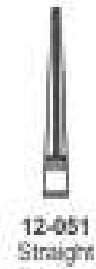
Hemostatic forceps



De Bakoy-Rankin
15 cm



De Bakoy-Mosquito
15 cm



Ochsner
12-053
22 cm



Diethrich
12-054
21 cm

COARCTATION CLAMPS

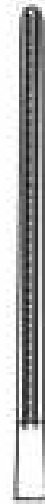
Coarctationsklemmen
Pinzas para coarctación

Pinces-Clamps pour coarctation
Morsetti di Coarctazione



12-055
21 cm
30 mm

Potts



12-056
22.5 cm
55 mm



Potts



12-057
20.5 cm
angled
30 mm

12-058
22 cm
angled
55 mm



Potts

12-059
20.5 cm
angled
30 mm



12-060
22 cm
angled
55 mm



Potts
12-061
21.5 cm
55 mm



Anastomosenklemmen, Ligaturklemmen

Pinces-clamps à anastomose, Pinces à ligatures

Pinzas para anastomosis, Pinzas para ligaduras

Morsetti per anastomosi, pinze per legature



Potts
12-062
22 cm
55 mm



De Bakay



12-063
19 cm



12-064
24 cm



De Bakay
12-065
18 cm



De Bakay
12-066
19 cm



PERIPHERAL VASCULAR CLAMPS

Peripheral-Gefäßklemmen
Pinzas para vasos periféricos

Pinces-clamps vasculaires périphériques
Morsetti vascolari periferici



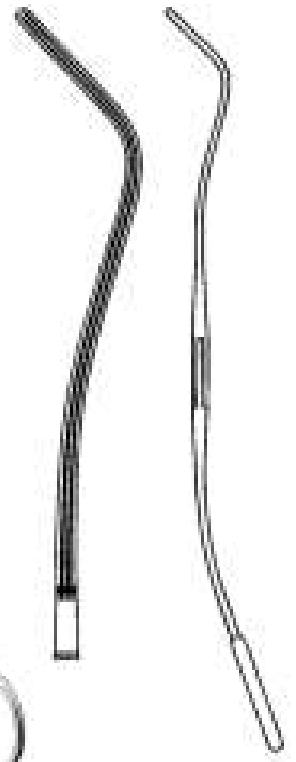
Multi purpose Vascular Clamps



De Bakay
12-067
20 cm



De Bakay
12-068
angled, 20 cm



12-069
18 cm



Leland-Jones



12-070
19 cm



12-071
20 cm



MULTI PURPOSE VASCULAR CLAMPS



Bainbridge



12-072
15 cm



12-073
18.5 cm



Bainbridge



12-074
15 cm



12-075
18.5 cm



De Bakay



12-076
26 cm



12-077
27 cm



12-078
31 cm



12-079
33 cm

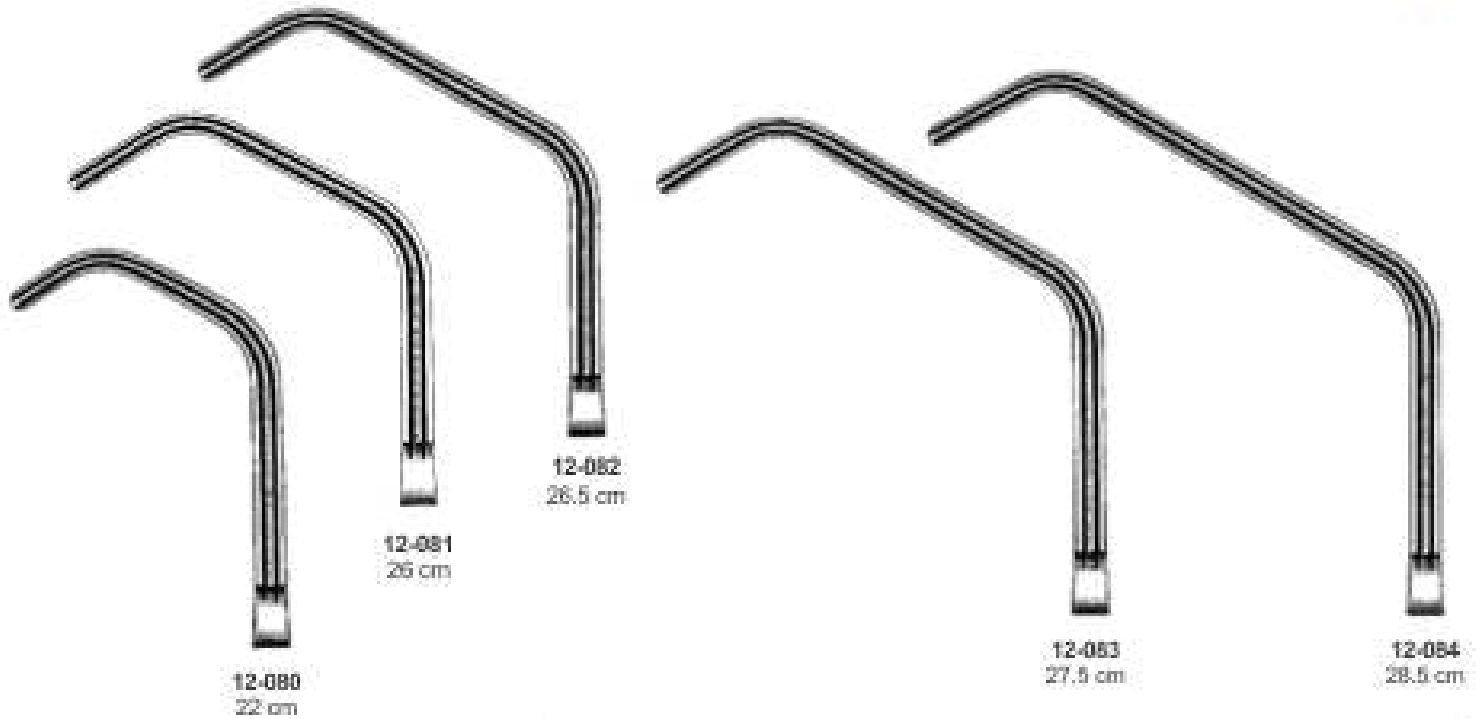


TANGENTIAL OCCLUSION FORCEPS



Tangential-Verschlußklemmen
Pinzas tangentes de oclusión

Pinces vasculaires pour occlusion tangentielle
Morsetti di occlusione tangenziale



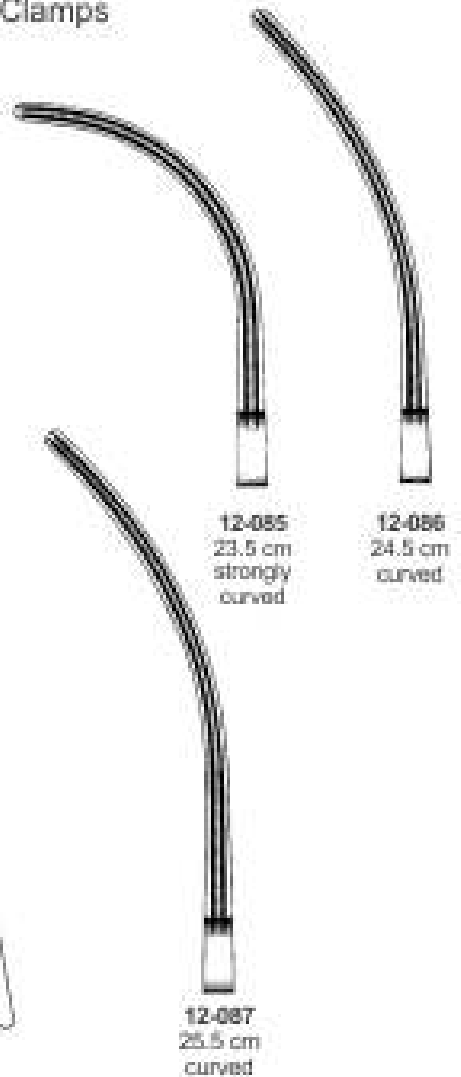
Aneurysm Clamps

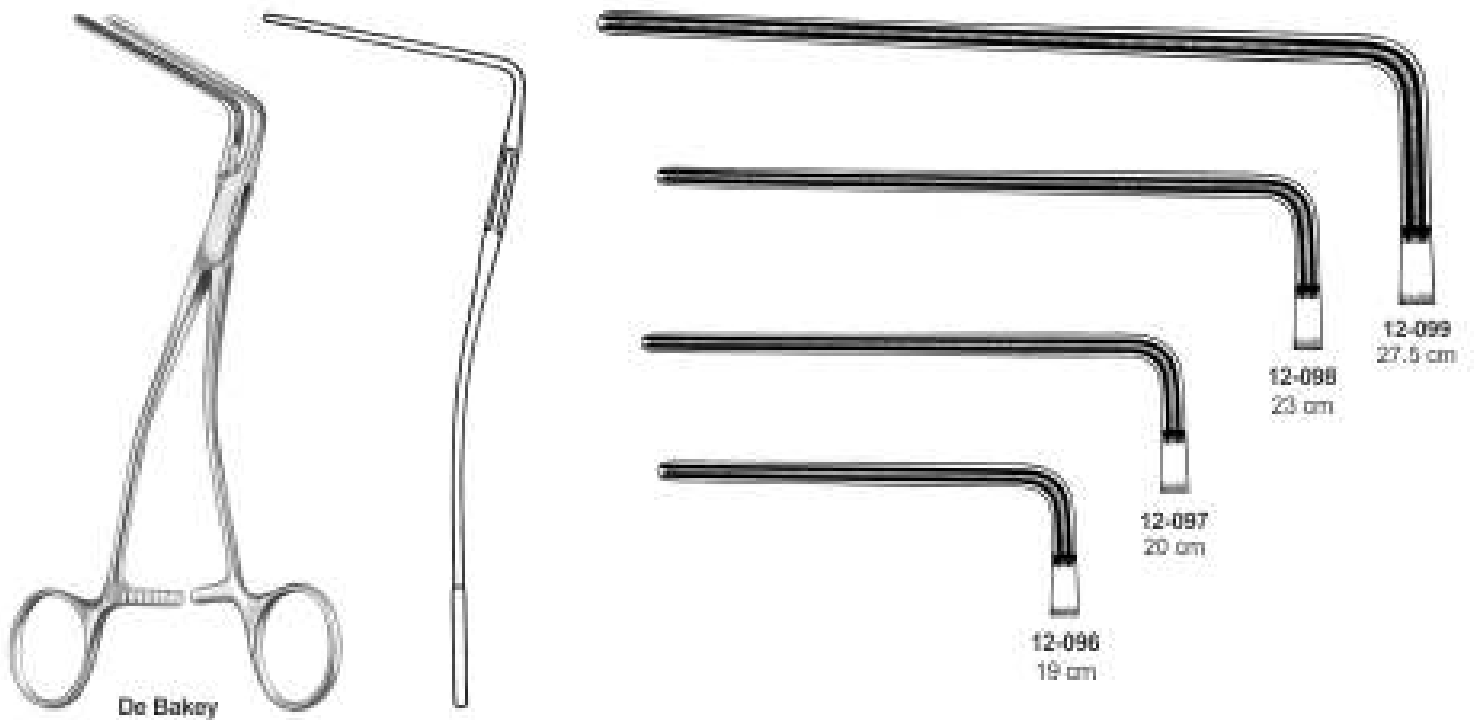


Salinsky



De-Bakey-Bahnson





MULTI PURPOSE VASCULAR CLAMPS



Mehrzweck-Gefäßklemmen

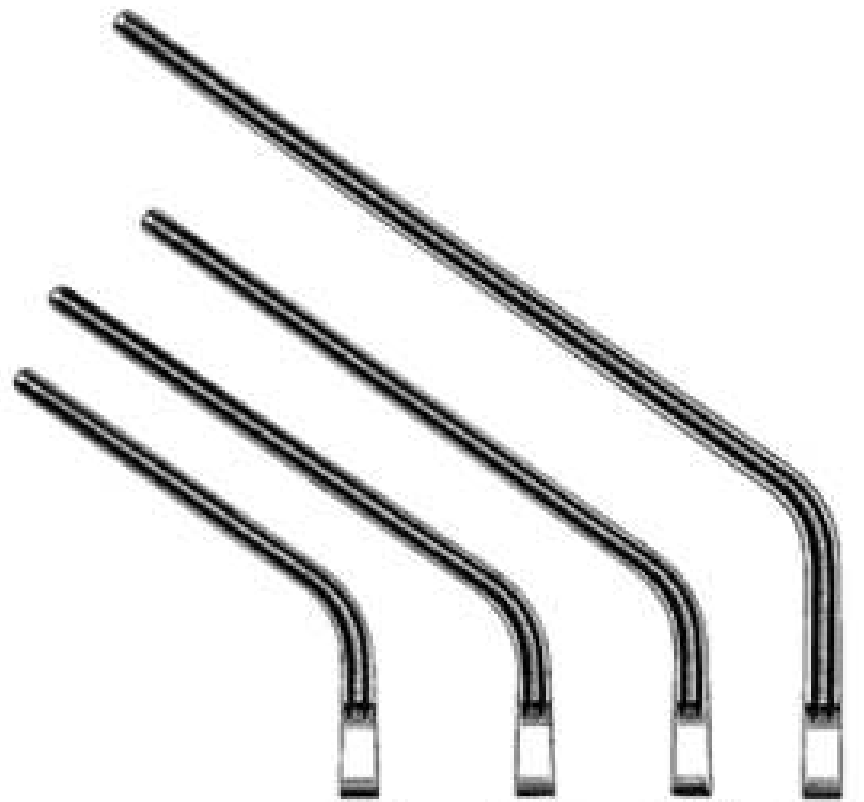
Pinças vasculares uniaxiais

Pinzas vasculares de usos múltiples

Morsetti vascolari multuso



De Bakoy



12-100
21 cm

12-101
22 cm

12-102
26 cm

12-103
31.5 cm



De Bakoy
12-104
straight
17.5 cm



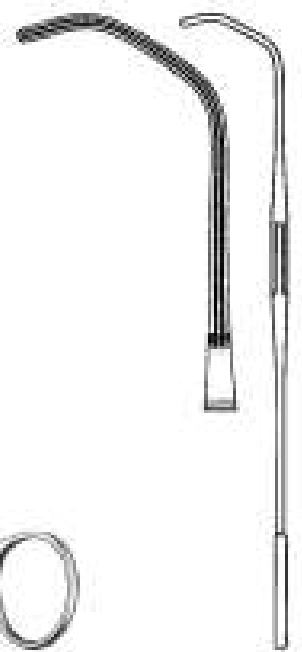
De Bakoy



12-105
strongly
angled
15 cm



De Bakoy Beck
12-106
17 cm



Anastomosis Clamps



Glover
12-107
curved
17 cm



Glover
12-108
spoon-shape
17.5 cm



De Bakay



12-110
16.5 cm

12-109
16.5 cm



Derra



12-111
16.5 cm



12-112
17 cm



12-113
17.5 cm



PEDIATRIC VASCULAR CLAMPS

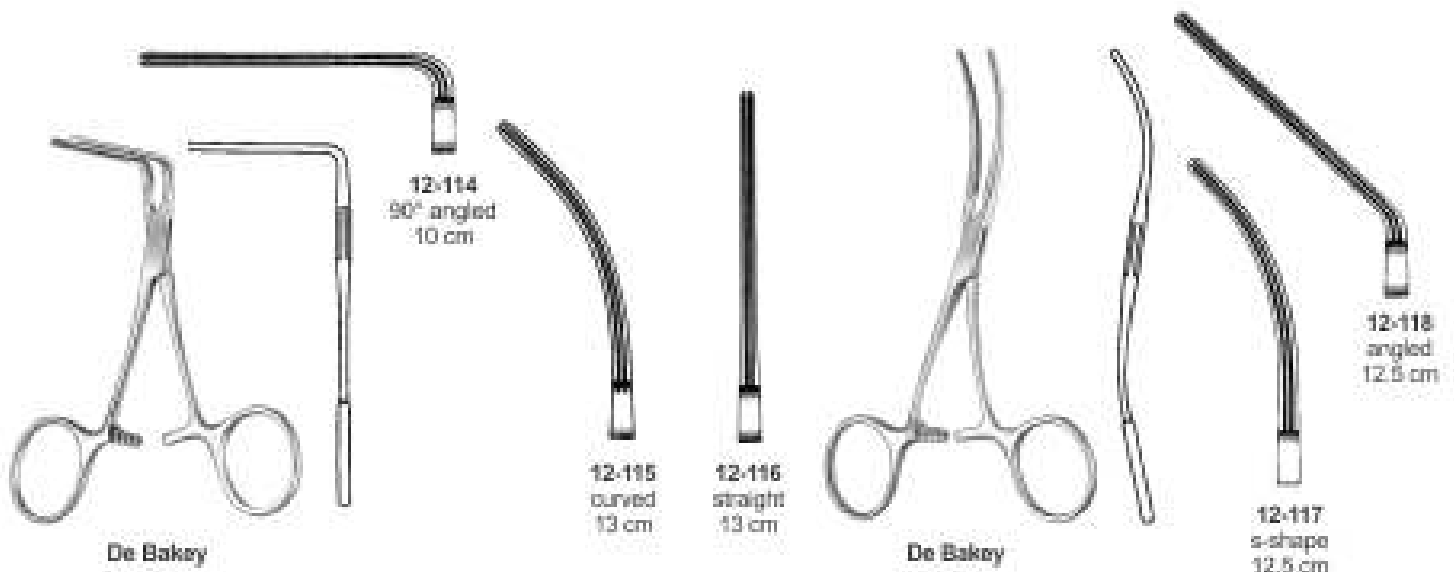


Kinder-Gefäßklemmen

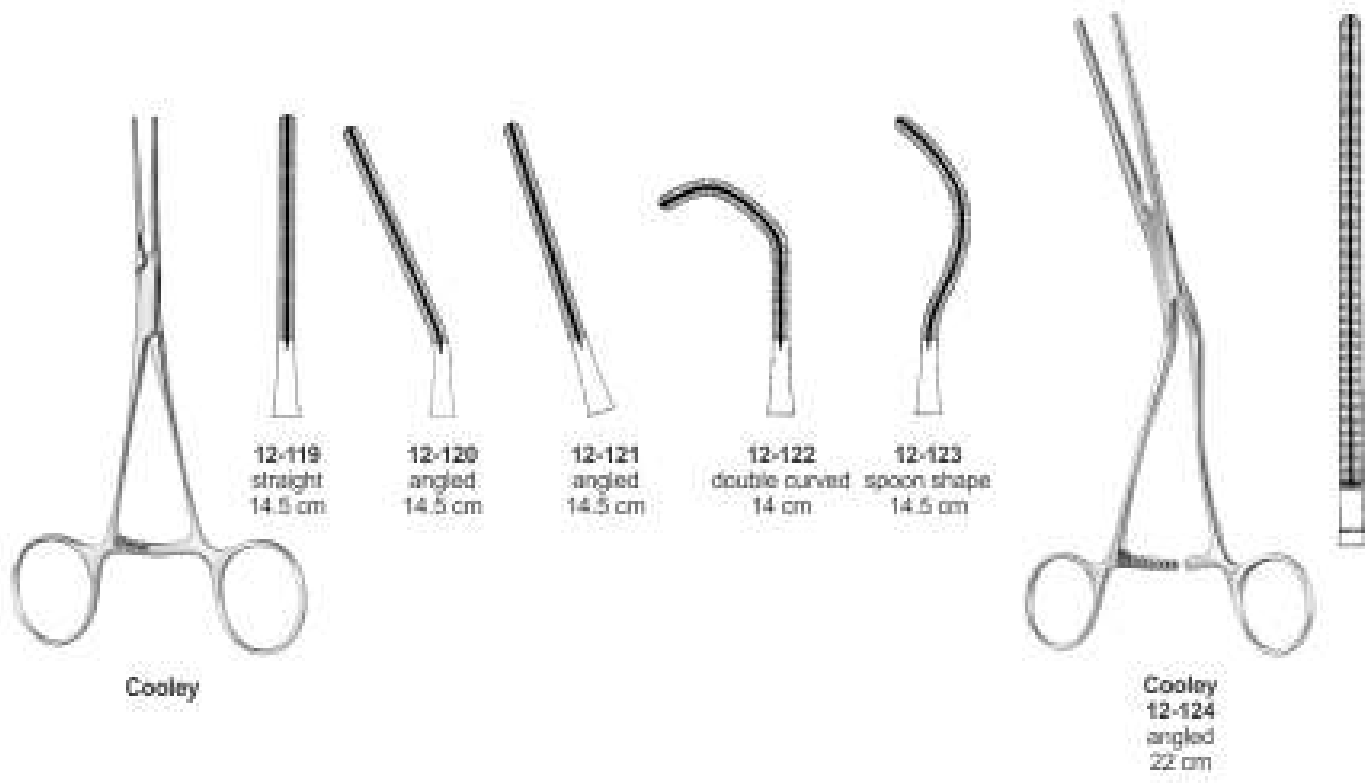
Pincès vasculaires pédiatriques

Pinzas vasculares pediátricas

Morsetti vascolari pediatrici



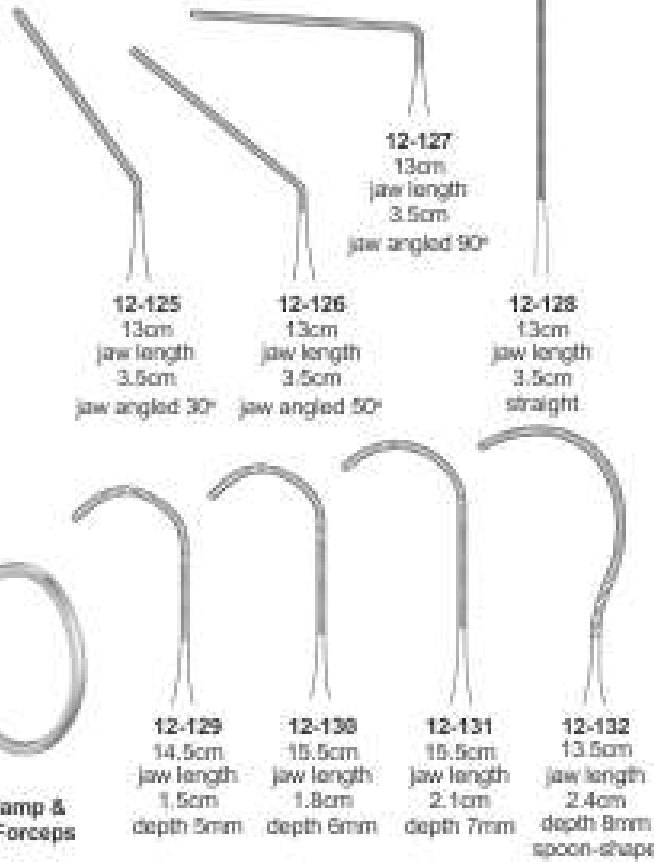
Anastomosis Clamps



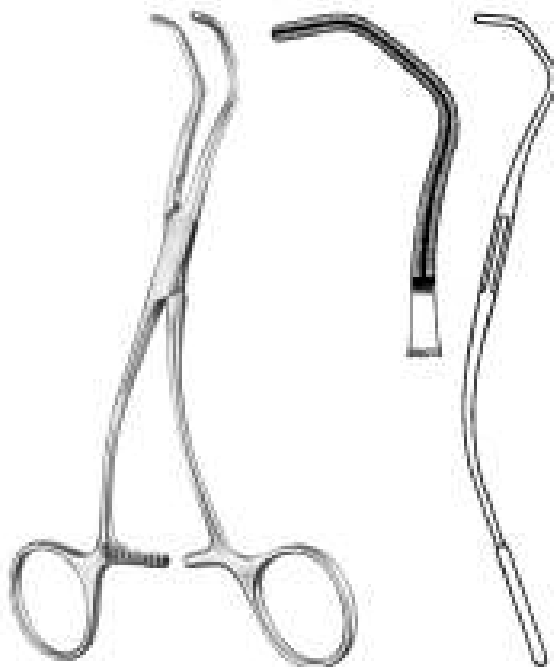
Neonatal Vascular Clamps



Castaneda Multipurpose Clamp & Atraumatic Cardiovascular Forceps



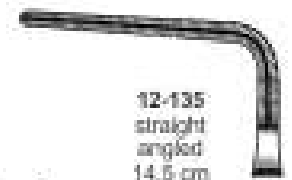
Cooley 12-133
curved sidewards
17 cm



Cooley 12-134
double curved
16 cm



Cooley



12-135
straight
angled
14.5 cm



12-136
medium
angled
16 cm

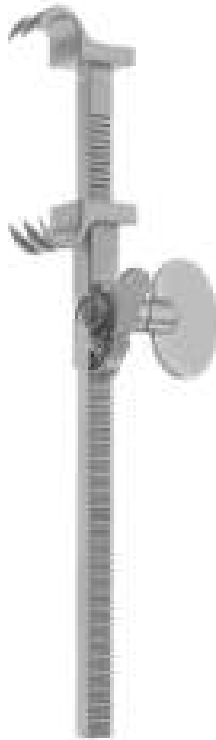


12-137
slight
angled
16.5 cm

RIB CONTRACTORS

Rippenkontraktoren
Aproximadores para costillas

Rapprocheurs des côtes
Approssimatori costali



**Bailey-Gibbon
Rib Contractors**
12-138
20 cm
For Adult



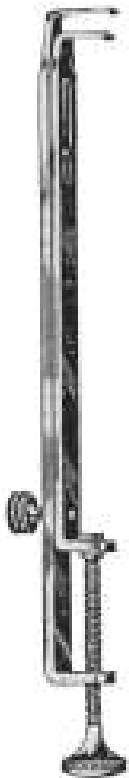
**Bailey-Gibbon
Rib Contractors**
12-139
20 cm
For children



**Bailey-Baby
Rib Contractors**
12-140
15 cm



Sellers Rib Contractor
12-141 20 cm



**Blalock
Rib Contractors**



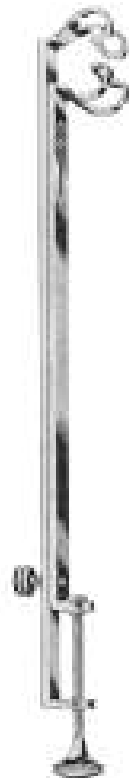
12-142
15 cm



12-143
20 cm



12-144
20 cm



**Johns-Hopkins
(Potts Modif.)
Rib Contractors**



12-145
20 cm



12-146
20 cm



12-147
20 cm

Lungenspatel, Aorta-Dilatatoren

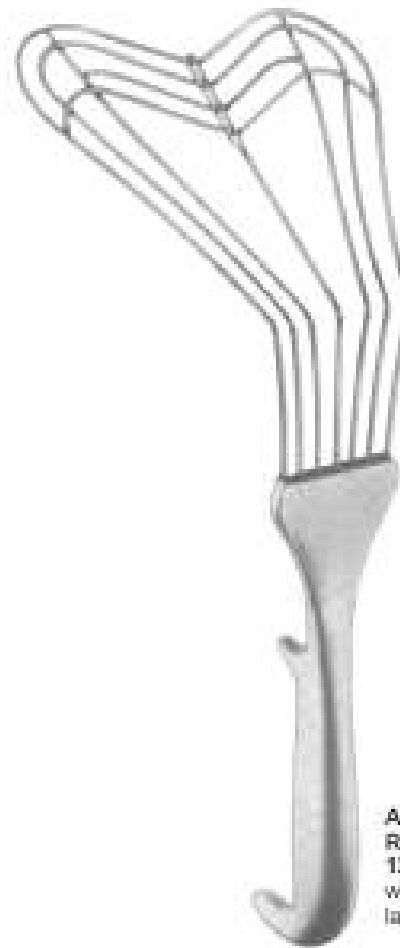
Spatules pulmonaires, Dilatateurs pour aorte

Espátulas pulmonares, Dilatadores aórticos

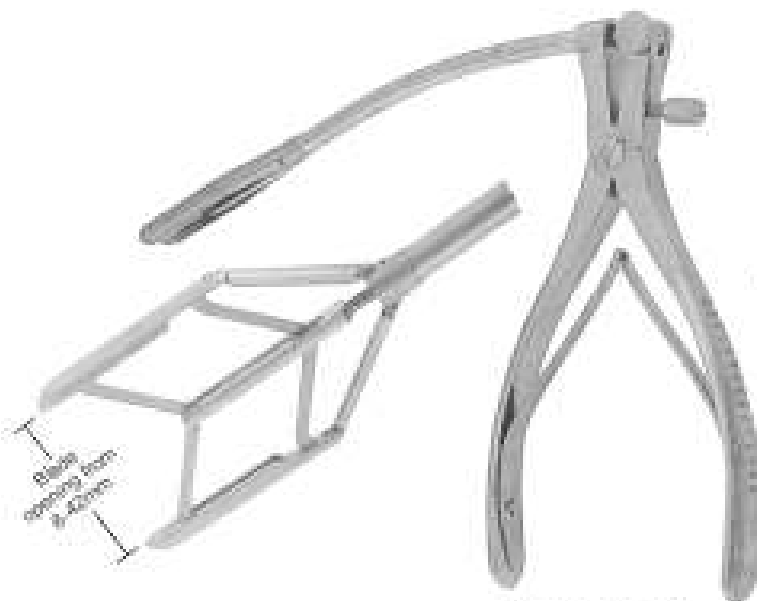
Spatole per pulmone, Dilatatori per aorta



Allison Lung Spatula Retractor
12-148 26 cm
12-149 30 cm
12-150 32 cm
wide 3.8cm
Small Size



Allison Lung Spatula Retractor
12-151 32.4 cm
wide 5.2cm
large size



Tubbs Mitral Valve Aortic Dilator
12-152
Blade Opening
From 8 To 42 mm



Coolley Blade Aortic Dilator
12-153
Blade Opening
From 8 To 15 mm

RIB RETRACTORS

Rippenspanner
Separador costal

Ecarteur de côtes
Divaricatore costale



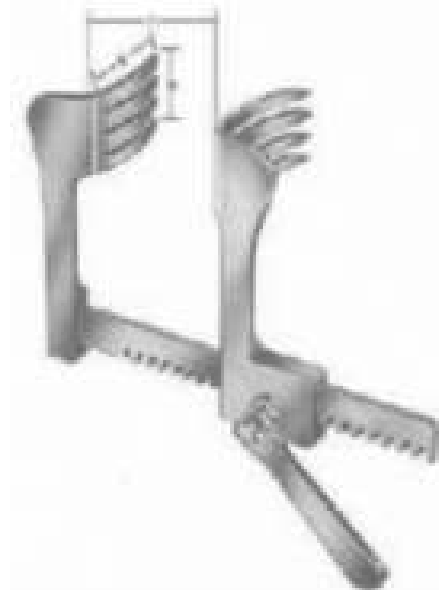
Morse 12-154
Sternal Retractor 4 movable
blades 22 x 27mm spreading 200 mm
Size 1.



DeBakey 12-155
Rib Retractor spreading 150 mm
Size 1.



DeBakey 12-156
Rib Retractor spreading 200 mm
Size 1.



Cherry 12-157
mm mm mm
44 70 135



Cooley Rib Retractors 12-158
lateral blades 12 x 16 mm spreading 95 mm



Cooley Rib Retractors
12-159 lateral blades 15 x 30 mm, spreading 140 mm
12-160 lateral blades 21 x 44 mm, spreading 150 mm



Coolay Rib Retractors

12-161
lateral blades 35 x 50 mm, spreading 200 mm



Finocchietto, Rib Retractors

12-162 lateral blades 15 x 15 mm, spreading 75 mm, infant
12-163 lateral blades 31 x 31 spreading 100 mm, baby - height
12-164 lateral blades 40 x 45 spreading 135 mm, baby - height
12-165 lateral blades 52 x 62 spreading 175 mm, baby - height
12-166 lateral blades 84 x 65 spreading 175 mm, baby - height



Haight Rib Retractor

12-167
lateral blades 30 x 30 mm, spreading 120 mm



Morse-Favaloro Sternal Retractor

12-168
4 movable blades 17 x 22 mm, spreading 160mm for children



Finocchietto (Modif.) Rib Retractors

12-169
lateral blades 14 x 15 mm, spreading 120 mm



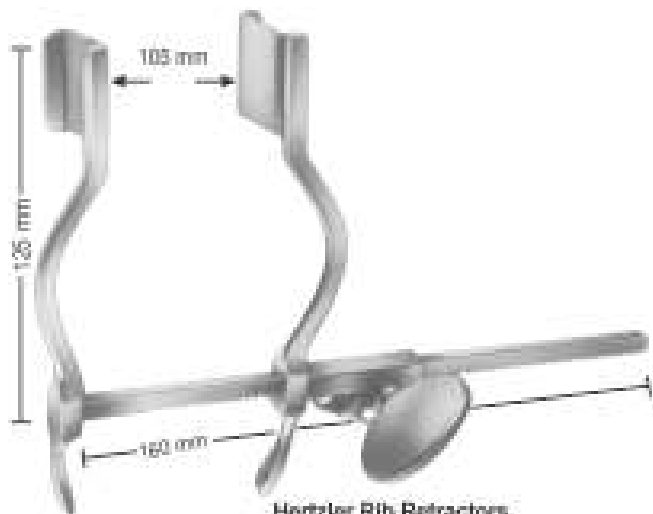
Tuffier Rib Retractor

12-170
lateral blades 45 x 45 mm, spreading 160 mm
12-171
lateral blades 22 x 27 mm, spreading 200 mm

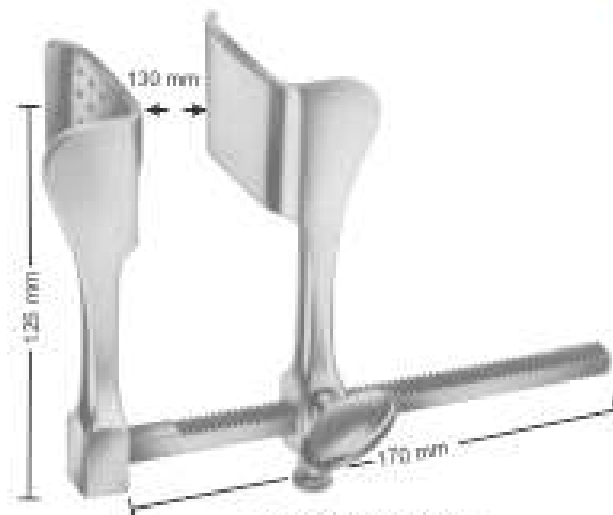
RIB RETRACTORS



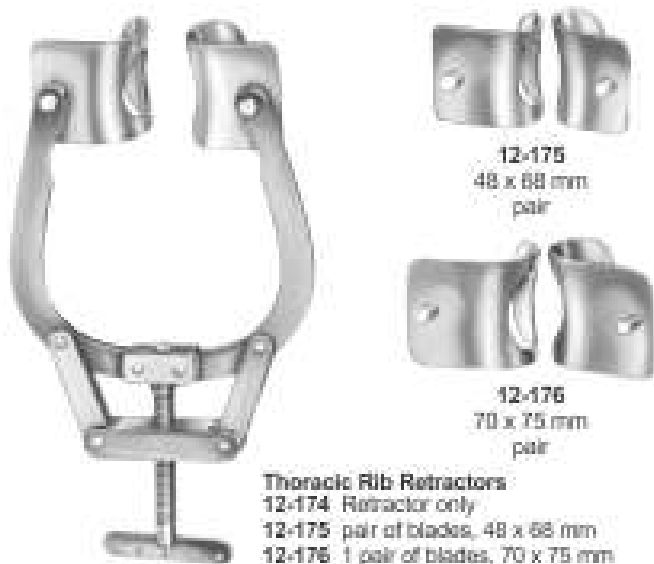
Rippenspanner | Ecarteur de côtes
 Separador costal | Divanicatoro costale



Hertzer Rib Retractors
 12-172
 blades 20 x 25 mm, spreading 105 mm



Tuffier Rib Retractors
 12-173
 blades 43 x 53 mm, spreading 130 mm



Thoracic Rib Retractors
 12-174 Retractor only
 12-175 pair of blades, 48 x 68 mm
 12-176 1 pair of blades, 70 x 75 mm



Thoracic & I.M.A Rib Retractors
 12-177 Complete set
 12-178 lateral blades for I.M.A Retractor
 left 40 x 50 x 80 mm
 12-179 lateral blades for I.M.A Retractor
 Right 40 x 50 x 80 mm



Burford Rib Retractors
 12-180
 18 cm For children
 spread with 2 sets of Blades
 12-181 48 mm x 42 mm spreading 135 mm
 12-182 38 mm x 42 mm spreading 135 mm



Burford Rib Retractors
 12-183
 18 cm For Adults
 spread with 2 sets of Blades
 12-184 with two pair of blade 47 x 62 mm + 65 x 62 mm spreading 200 mm
 12-185 with 2 pair of blade 47 x 62 mm + 65 x 62 mm spreading 260 mm
 12-186 with 2 pair of blade 47 x 62 mm + 65 x 62 mm spreading 300 mm

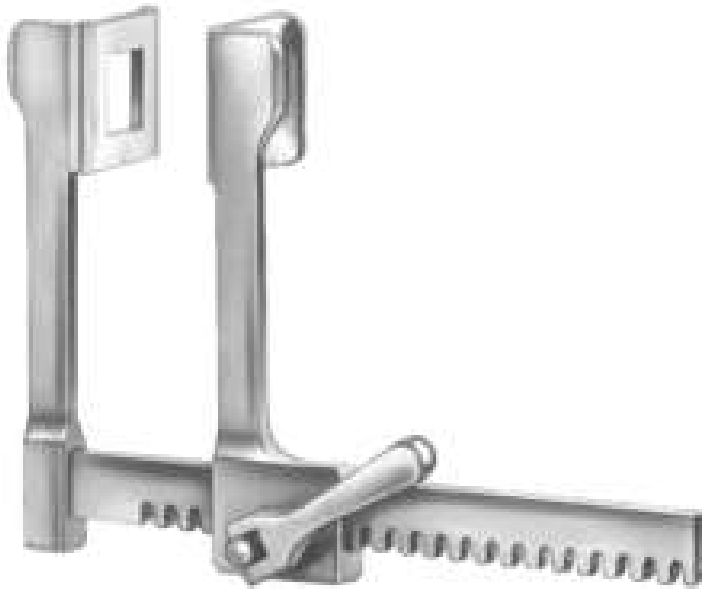
RIB RETRACTORS

Rippenspanner

Ecarteur de côtes

Separador costal

Divaricatore costale



Finocchietto/Baby Rib Retractors
12-187 7.5 cm
14 mm x 15 mm spreading 75 mm



Finocchietto, Rib Retractors
20 cm
12-188 30 mm x 45 mm, spreading 150 mm
12-189 45 mm x 62 mm, spreading 190 mm
12-190 80 mm x 65 mm, spreading 190 mm



Castaneda Rib Retractors
12-191 10.5 mm x 32 mm
spreading 65 mm



Castaneda Rib Retractors
12-193 15 mm x 60 mm
spreading 120 mm



Castaneda Rib Retractors
12-192 12 mm x 45 mm
spreading 70 mm

RIB SHEARS, STERNUM CHISEL

Rippenscheeren, Sternummeißel	Costotomes, ciseau-Burin à sternum
Costotomos, Cinceles	Costotomi, Scalpello per sterno



Sauerbruch-Frey Rib Shears
12-194
for the first rib
37 cm



Schumacher Rib Shears
12-195
sternum shears
21 cm



Bone Rib Shear
12-196
23 cm



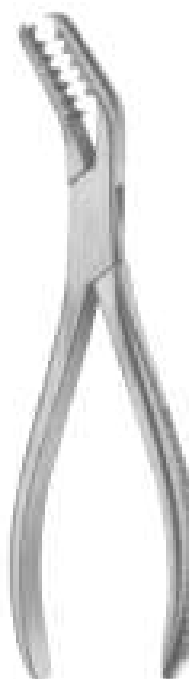
Rib Shear
12-197
23 cm



Gluck Rib Shear
12-198
22 cm



Labsche Sternum Chisel
12-199 24.5 cm



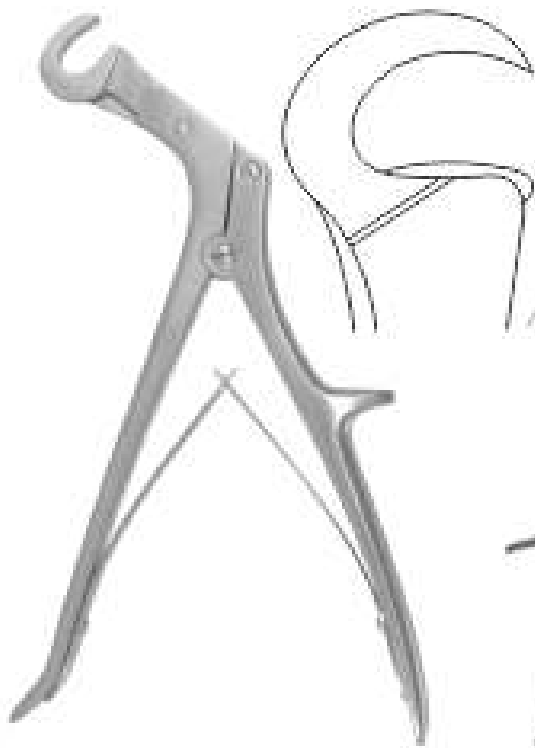
Somb Rib Shears
12-200 20 cm



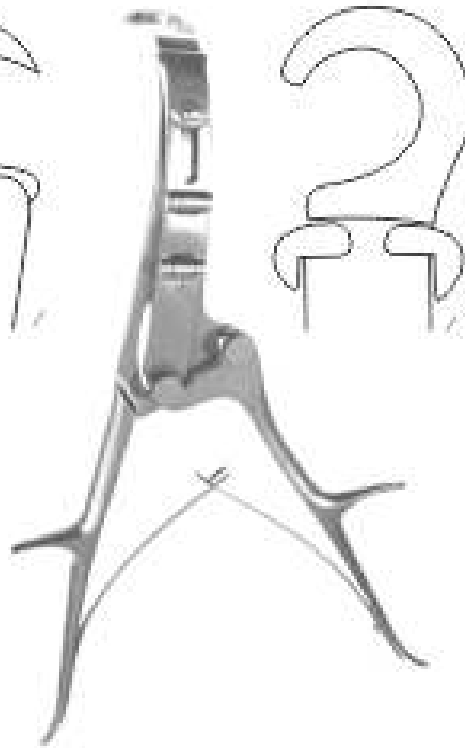
Somb Rib Shears
12-201 20 cm

Rippenscheren, Sternummeißel
Costotomos, Cinceles

Costotomes, ciseau-Burin à sternum
Costotomi, Scalpello per sterno



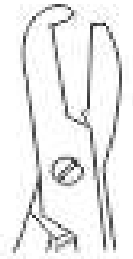
Glertz-Stille Rib Shears
12-202 27 cm



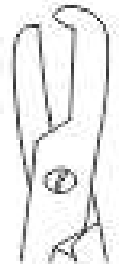
Brunner Rib Shears
12-203 33.5 cm



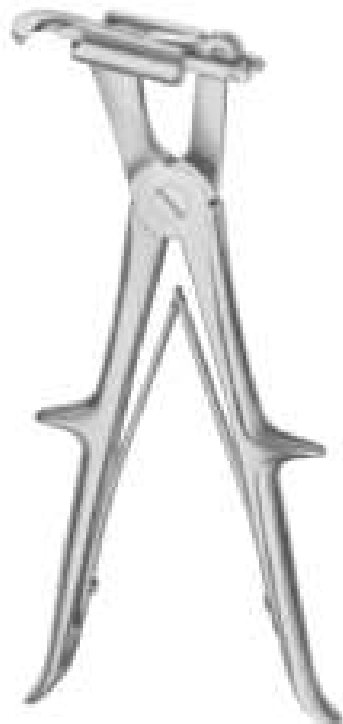
Maurer-Collin Rib Shears



12-204
Hooked Left
23 cm



12-205
Hooked Right
23 cm



Sauerbruch Rib Shears
12-206 24 cm, For Children
12-207 27 cm, For Adults



Schuardt Rib Shears
12-208 17 cm



Collin Rib Shears
12-209 19 cm

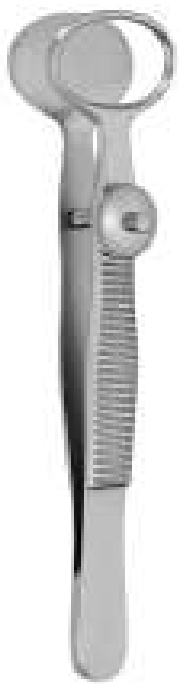


Doyen Rib Shears
12-210 19 cm

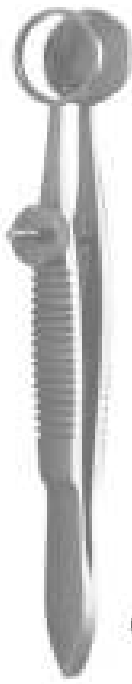
OPHTHALMIC INSTRUMENTS



Micro Forceps



Chalazion Clamp
13-001
11cm



Chalazion Forceps
13-002
Oval 12 X 14mm, 10 cm long



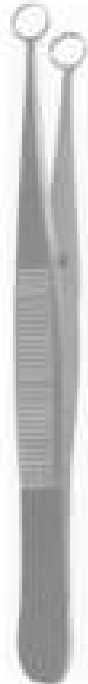
13-003
Round 8mm,
10 cm long



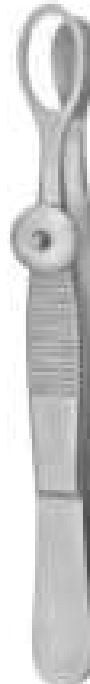
13-004
Round 15mm,
10 cm long



13-005
Oval 17 X 9mm,
10 cm long



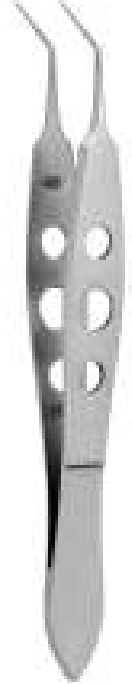
Chalazion Forceps
13-006



Cauer
13-007
10 cm
Chalazion Forceps



Suture Tying Forceps
13-008 9cm
13-009 11cm



McPherson Forceps
13-010 9cm
13-011 11cm



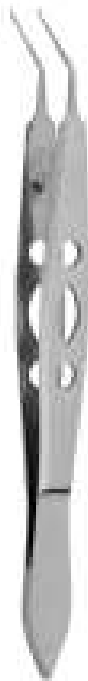
Corneal Forceps
1x2 (0.12)
13-012 9cm
13-013 11cm



Bonn Forceps
13-014
11cm



Ultrata
Capsulorhexis
Forceps
13-015 11cm
Curved



Ultrata
Capsulorhexis
Forceps
13-016 11cm
Straight



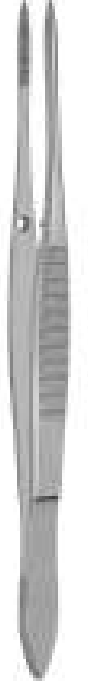
Colibri Forceps
1x2 (0.12)
13-017



Holding & Folding
Forceps
for Acrylic Lenses
13-018
11cm



Holding & Folding
Forceps
for Acrylic Lenses
13-019
11cm



Morefield Forceps
13-020
11cm

Round Handle Available



Suture Tying Forceps
13-021 9cm
13-022 11cm

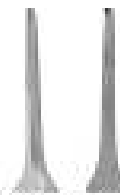
Round Handle Available



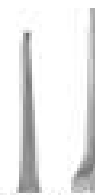
McPherson Forceps
13-023 9cm
13-024 11cm



Corneal Forceps
9x2 (0.12)
13-025 9cm
13-026 11cm



Bonn Forceps
13-027 9cm
13-028 11cm



Ultrata Capsulorhexis Forceps
13-029 9cm
13-030 11cm
Curved



Ultrata Capsulorhexis Forceps
13-031 9cm
13-032 11cm
Straight



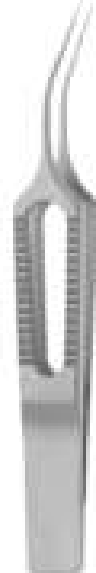
Holding & Folding Forceps
for Acrylic Lenses
13-033 9cm
13-034 11cm



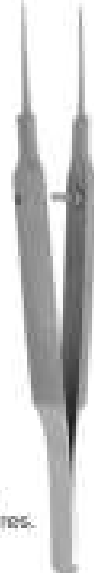
Holding & Folding Forceps
for Acrylic Lenses
13-035 9cm
13-036 11cm



Colibri Forceps
with tying platform
13-037



Gerl
Tying Forceps
curved shanks
8mm long platform
For 8-0 to 11-0 sutures.
titanium
13-038



Tennant
Tying Forceps
extra delicate smooth jaws
with 6mm long platform
round handle with guide pin
For 9-0 to 11-0 sutures.
13-039 straight
13-040 straight, titanium
13-041 curved
13-042 curved, titanium

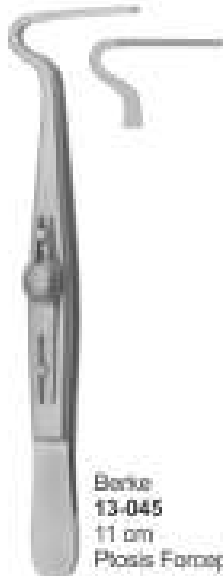


Self-Retaining
Retractors



13-043
10 cm
sharp

13-044
10 cm
blunt



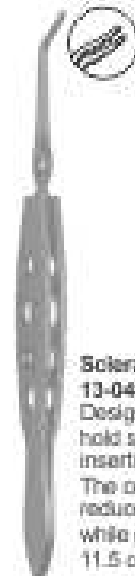
Berke
13-045
11 cm
Plois Forceps



Förster
13-046
10 cm
Conjunctiva
Forceps



Fechner Conjunctiva
Forceps
13-047 11 cm long
Very delicate ring tips,
with tying
platforms



Scleral Plug Forceps
13-048
Designed to securely
hold scleral plugs during
insertion and removal.
The cross-action handle
reduces hand fatigue
while grasping plug.
11.5 cm long



Round Handle Available



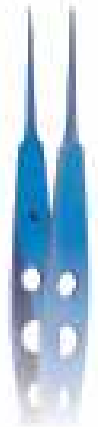
13-050

McPherson
Forceps
13-049



13-052

Suture Tying
Forceps
13-051



13-054

Ultrata Capsularhexis
Forceps
13-053



13-056

Comasal Forceps
1x2 (0.12)
13-055



Colibri
Forceps
extra delicate
1x2 teeth, 0.12mm
with tying platform
13-057



13-058
Cooley
18 cm



13-059
Castroviejo TC
18cm



13-060
Noyes Micro Scissors
CVD 18cm

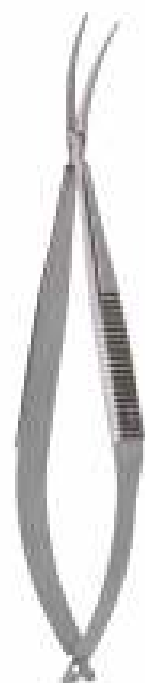


Needle Holder
delicate, curved, without lock,
overall length: 115mm, titanium
ideal for 9-0 to 10-0 sutures
13-061 with lock
13-062 without lock
13-063 titanium, with lock
13-064 titanium, without lock



Barraquer
Needle Holder
delicate jaws, straight
13-065 with lock
13-066 without lock
13-067 titanium, with lock
13-068 titanium, without lock

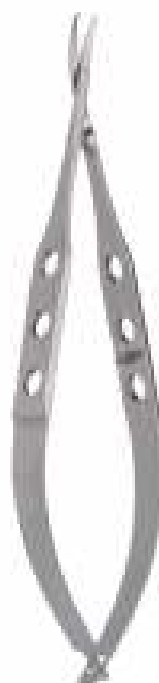
Micro Scissors



IDL Holding Forceps
13-069 11.5cm



Micro Needle Holders
13-070 11.5cm



Corneal Scissors
13-071 11.5cm



Capsulotomy Scissors
13-072 11.5cm



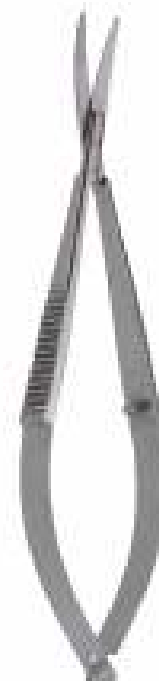
Vannas Scissors
13-073 11.5cm
Straight



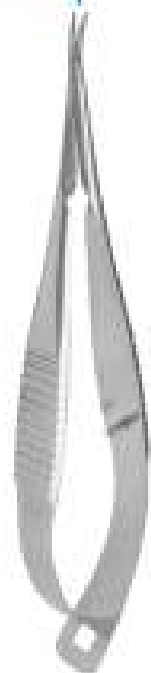
Vannas Scissors
13-074 11.5cm
Curved



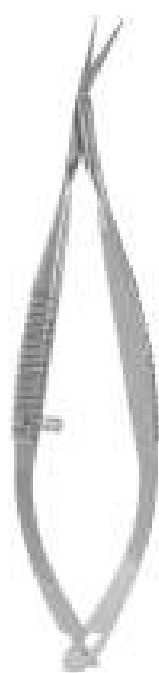
Westcott Scissors
13-075 11.5cm



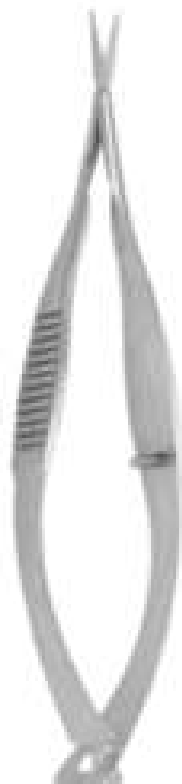
Iris Scissors
13-076 11.5cm



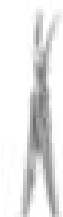
Vannas Scissors
13-077
Sharp pointed tips. Curved 7.5mm blades, 9.5mm from pivot to tip, 8 cm long



Vannas Scissors
13-078
Sharp tips. Angled to side 7mm blades, 9mm from pivot to tip, 8 cm long



13-079



13-080



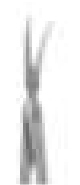
13-081



13-082



13-083



13-084

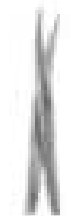


13-085

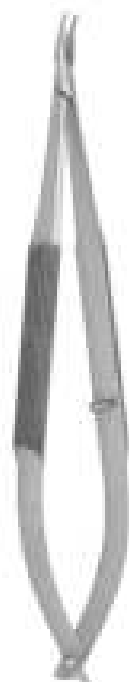
Capsulotomy Scissors Vannas
5mm long blades, sharp tips
13-079 straight
13-080 curved
13-081 angled forward
13-082 angled to side

Gills-Vannas
7mm long blades, sharp tips
13-083 straight
13-084 curved
13-085 angled forward

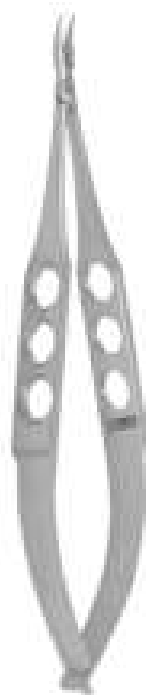
McPherson-Vannas
8mm long blades, sharp tips
13-086 curved



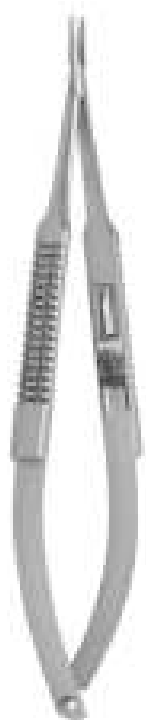
13-086



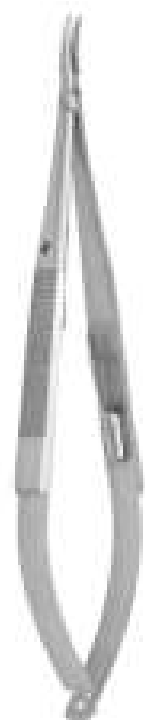
Barraquer
Needle Holder
delicate jaws, curved
13-087 with lock
13-088 without lock



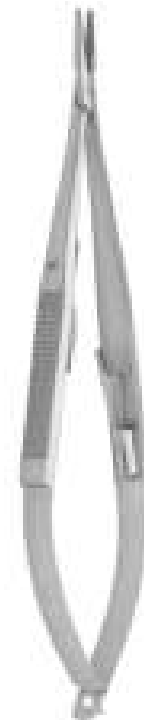
McPherson
Needle Holder
very delicate jaws
13-089 with lock straight
13-090 without lock straight
13-091 with lock curved
13-092 without lock curved



Micro Needle Holder
Needle Holder
delicate jaws
strongly curved
13-093 with lock
13-094 without lock



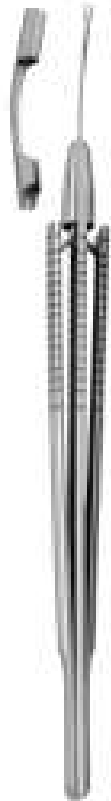
Castroviejo
Needle Holder
delicate jaws, curved
13-095 with lock
13-096 without lock



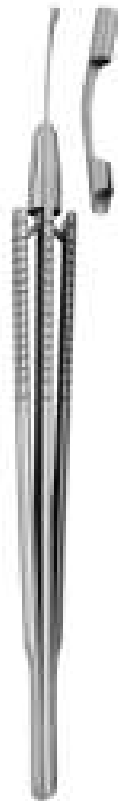
Castroviejo
Needle Holder
standard jaws
straight, with lock
13-097
13-098 TC Tungsten Tip



Kalt
Needle Holder
delicate smooth jaws
straight, with lock
13-099



Micro Incision Forceps
13-100



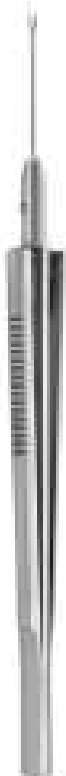
Micro Incision Scissors
13-101



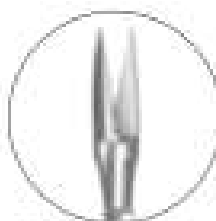
Endothelial Grasping
Forceps
curved, 23 gauge
delicate end-gripping
platforms jaws 90°
off-set from "squeeze handle"
mechanism
13-102



Vitreoretinal Forceps
Lens Cartridge
Loading Forceps
straight, 20 gauge
13-103



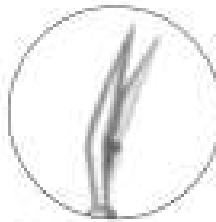
Vitreotomy Scissors
T20 gauge shears.
Stainless steel
construction with
flat handle.
Autoclavable.



Scissors
horizontal opening
straight
13-104



Scissors
horizontal opening
angled 60°
13-106



Scissors
horizontal opening
angled 30°
13-105



Scissors
horizontal opening
angled 80°
13-107



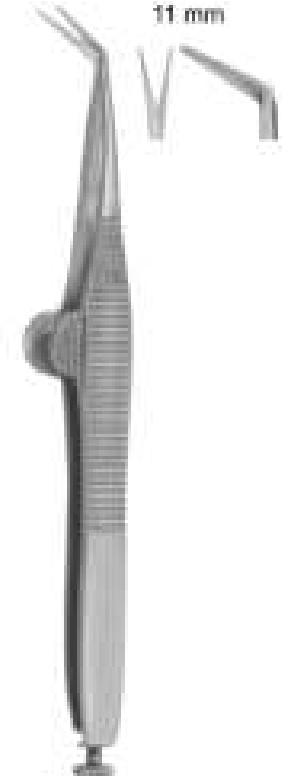
Troutman-Castroviejo
delicate patterns, with stop



13-108
10.5 cm
right



13-109
10.5 cm
left



Wecker
13-110
11 cm
pointed-pointed

Cannulas



Sterilizing Boxes (with silicon Pads)

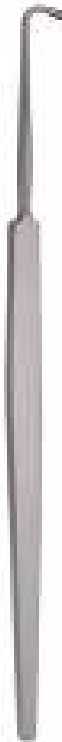




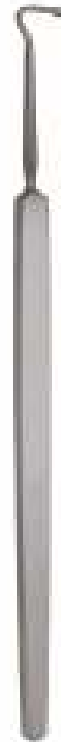
Curette
13-124



Wire Vectus
13-125



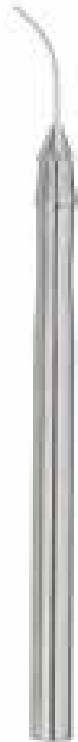
Strabismus Hook
13-126



Lense Expressor
13-127



Bimanual Hand Irrigation
13-128



Bimanual Hand Aspiration
13-129



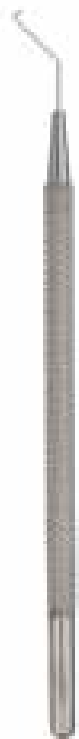
Rosen Phaco Splitter
60° angled wedge shaped inferior edge with blunt tip
13-130
Titanium



Nagahara Chopper
13-131



Sinskey Hook
13-132



Sinskey Hook
13-133



Nagahara Chopper
13-134



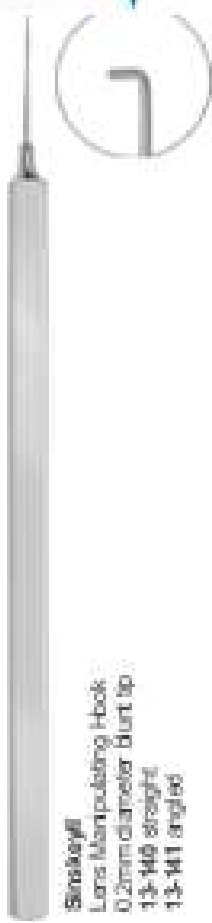
Lachrymal Dilator Double Ended
13-135



Lachrymal Dilator
13-136 Fine Taper
13-137 Medium Taper
13-138 Heavy Taper



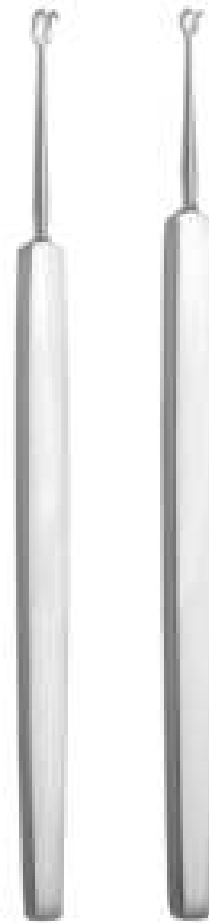
Lachrymal Probes
13-139



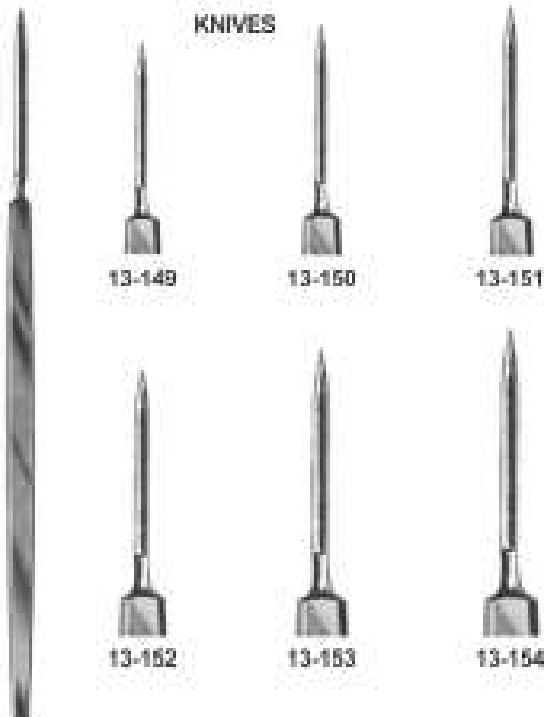
Sinskey's
Lens Manipulating Hook
0.2mm diameter blunt tip
13-140 straight
13-141 angled



Lens Manipulating Hook
0.10mm diameter tip
13-142
Fenzl, round handle, straight with guard
13-143
Fenzl, round handle, angled
13-144
Maltzman-Fenzl, round handle,
13-145
Maltzman-Fenzl, round handle, angled
13-146
Jaffe-Maltzman, fat handle, angled



Fixation Hook
double, sharp
13-147
15 cm
13-148
18 cm



KNIVES

VON GRAEFE Knife
Graefe
1,2,3,4,5



Jaeger Lid Plate
13-155
Jaeger
4", 20mm, 23mm

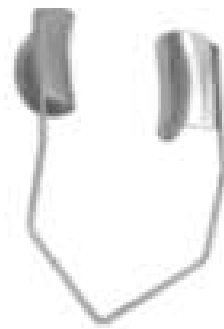


Eye Knives

13-156
Fig. 1
13-157
Fig. 2
13-158
Fig. 3
Jaeger



Barraquer Wire Speculums
13-159
heavy wire, 15mm blades



Barraquer Solid Blade Wire Speculum
13-160
Barraquer, 10mm blades



Kratz - Barraquer Wire Speculum
15mm blades
one solid and one open wire
13-161
for right eye



Kratz - Barraquer Wire Speculum
15mm blades
one solid and one open wire
13-162
left eye



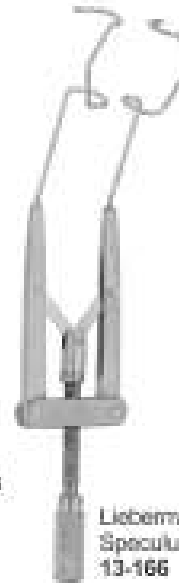
Wire Speculums
13-163



Wire Speculums
13-164



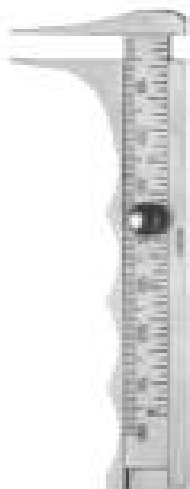
Laster-Burch Speculum
eye Speculum with flanges on blades for retaining eye lashes
adjustable mechanism with locking screw
13-165
11mm blades



Lieberman Speculum
13-166



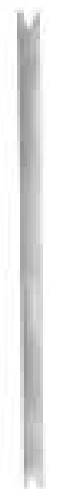
Clark Speculums
13-167



Jameson Caliper chrome plated
13-168



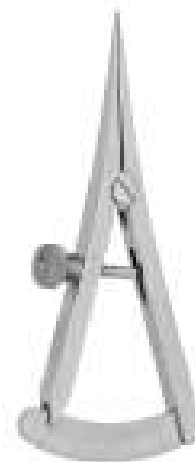
Braunstein Caliper
3.5/4.0mm
Stainless Steel
13-169



13-170 Caliper
Fixed



Fixed Caliper
13-171



Gastroviejo Caliper
20mm spread
13-172 straight
13-173 angled
13-174 curved



Maloney Intra-Operative Keratometer Titanium
For qualitative measurement of astigmatism.
13-175

ENT SURGERY



EAR SPECULUM



Ohrspekulum

Spéculum auriculaire

Espéculo de oreja

Speculum auricolare



14-001
4.5 mm Ø



14-002
5.5 mm Ø



14-003
6.5 mm Ø



14-004
7.5 mm Ø



14-007
2 mm Ø



14-008
3 mm Ø



14-009
4 mm Ø



14-010
5 mm Ø



Toybee Ear Speculum
3.8 cm 1 1/2"
Set for adults

14-005
Set of 3
5.5 mm
6.5 mm
7.5 mm

14-006
Set of 4
4.5 mm
5.5 mm
6.5 mm
7.5 mm



Politzer Ear Speculum
Set for adults

14-011
Set of 3
2 mm
3 mm
4 mm

14-012
Set of 4
2 mm
3 mm
4 mm
5 mm



Gruber Ear Speculum
Set for adults



14-013
a - 4.5 mm Ø



14-014
a - 5.5 mm Ø



14-015
a - 6.5 mm Ø



14-016
a - 7.5 mm Ø



Gruber Ear Speculum
Set for adults



14-017
a - 4.5 mm Ø



14-018
a - 5.5 mm Ø



14-019
a - 6.5 mm Ø



14-020
a - 7.5 mm Ø



Boucheron Ear Speculum
Set for adults



14-021
4.5 mm Ø



14-022
5.5 mm Ø



14-023
6.5 mm Ø



14-024
7.5 mm Ø



Boucheron Ear Speculum
Set for children



14-025
3 mm Ø



14-026
4.5 mm Ø



14-027
5.5 mm Ø

EAR SPECULUM

Ohrspekulum

Especúlo de oreja

Spéculum auriculare

Speculum auricolare



- **14-028**
2 mm Ø
- **14-029**
3.5 mm Ø
- **14-030**
5 mm Ø

Hartmann Ear Speculum
for children



- **14-031**
4.5 mm Ø
- **14-032**
5.5 mm Ø
- **14-033**
6.5 mm Ø
- **14-034**
7.5 mm Ø

Hartmann Ear Speculum
Set for adults



- **14-035**
4.5 mm X 6.5 mm
- **14-036**
6.5 mm X 7.5 mm
- **14-037**
7.5 mm X 8.5 mm
- **14-038**
9.5 mm X 9.5 mm
- **14-039**
9.5 mm X 10.5 mm
- **14-040**
10.5 mm X 11.5 mm

Zöllner Ear Speculum
Set for adults, Black



- **14-041**
2 mm
- **14-042**
3.5 mm
- **14-043**
5 mm
- **14-044**
6.5 mm
- **14-045**
7.5 mm

Hartmann Ear Speculum
Set for adults, Black



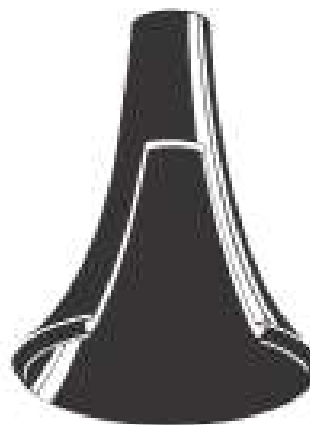
Gruber Aural Specula
Ear Speculum
Black finish, 38 mm Ø

- 14-046** Set of 4
- 14-047** 3 mm
- 14-048** 4 mm
- 14-049** 5 mm
- 14-050** 7 mm



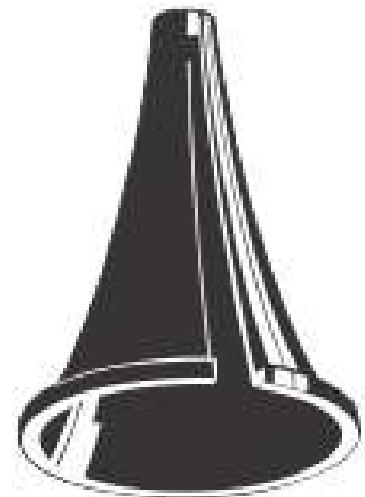
Rosen Ear Speculum
Black finish, Slotted round ends 38 mm Ø

- 14-051** Set of 4
- 14-052** 3 mm
- 14-053** 4 mm
- 14-054** 5 mm
- 14-055** 7 mm



Rosen Ear Speculum
slotted round ends
Black finish, 35 mm Ø

- 14-056** Set of 4
- 14-057** 4 mm
- 14-058** 5 mm
- 14-059** 6 mm
- 14-060** 7 mm



Tumarkin Ear Speculum
Tapered slot set of 8

- 14-061** 4.5 mm
- 14-062** 6.5 mm
- 14-063** 7.0 mm
- 14-064** 7.5 mm
- 14-065** 8.0 mm
- 14-066** 8.5 mm
- 14-067** 9.0 mm
- 14-068** 11 mm

EAR SPECULUM

Ohrspekulum

Spéculum auriculaire

Especúla de oreja

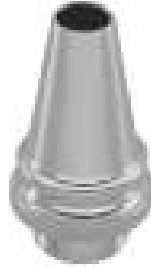
Speculum auricolare



14-069
6.5 mm Ø



14-070
7 mm Ø



14-071
8 mm Ø

Siegle Magnifier Ear Speculum
14-072
Complete Set
with 3 Ear Specula & Otoscope



Bruenings completa
14-073
Bruenings Ear Speculum
Complete Set
with 4 Ear Specula & Otoscope



Siegle Magnifier
Otoscope



14-074
6.5 mm Ø



14-075
7.5 mm Ø



14-076
8.5 mm Ø



14-077
9.5 mm Ø



Bruening Magnifier
Otoscope

Spekulum, Zerstauber und Ohrenspritzen

Especulo de oreja, atomizador y jeringas de oreja

en auriculaire, atomiseur et seringues auriculaires

Speculum auriculari, atomizzatori e stringhe auricolari

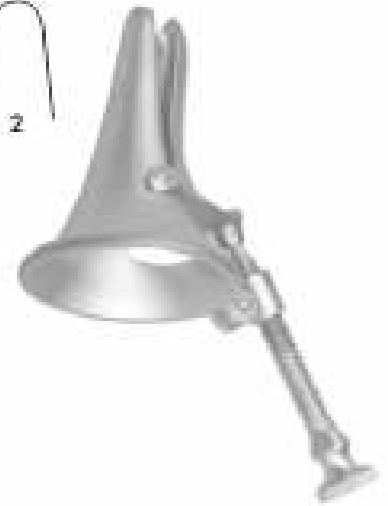
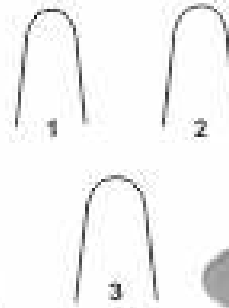


**Richnau Holmgren
Ear Speculum**
3.5 cm

- 14-078
3 mm Ø
- 14-079
4 mm Ø
- 14-080
5 mm Ø
- 14-081
6 mm Ø



Vacher Nasal Speculum
14-082

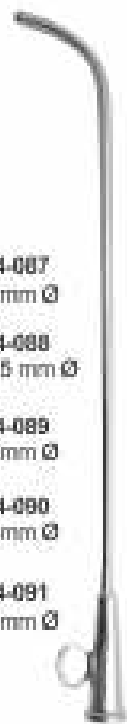


Vacholini Nasal Speculum
14-083 Fig. 1
14-084 Fig. 2
14-085 Fig. 3



Yankauer
14-086
15cm

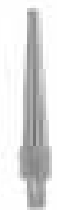
- 14-087
2 mm Ø
- 14-088
2.5 mm Ø
- 14-089
3 mm Ø
- 14-090
4 mm Ø
- 14-091
5 mm Ø



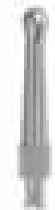
Hartmann
Eustachian Catheters



Reiner Ear syringe
14-092
50CC Complete
14-093
75CC Complete



**Reiner Ear
Syringe
Tip Only**
14-096
Tip Only



**Reiner Ear
Syringe
Tip Only**
14-097
Tip Only

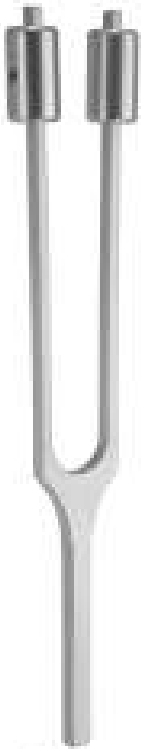


**Reiner Ear
Syringe Shield**
14-098

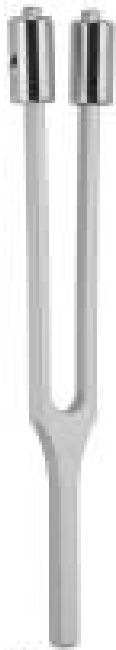
14-094
100CC Complete
14-095
150CC Complete
Reiner Ear syringe
With Tip & Shield

TUNING FORKS

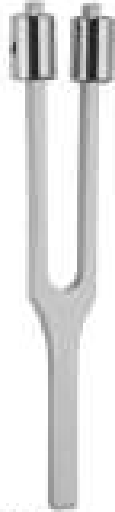
Stimmgabeln | Diapasones
Diapasons | Diapasoni



Hartmann
Tuning Fork
14-099
C 64



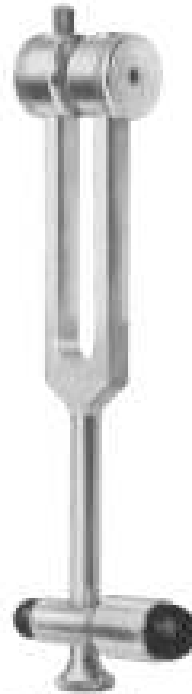
Hartmann
Tuning Fork
14-100
c 128



Hartmann
Tuning Fork
14-101
c1 256



Hartmann tuning
fork with or without
plastic base a1 440
14-102
a1 440



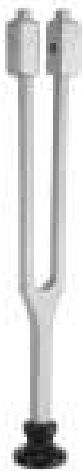
Tuning Forks neurot
with hammer
14-103



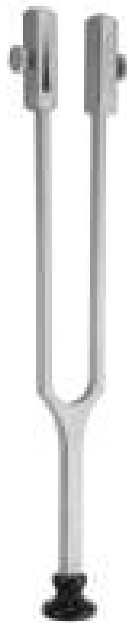
Barany Noise Drum
14-104

NOISE DRUM

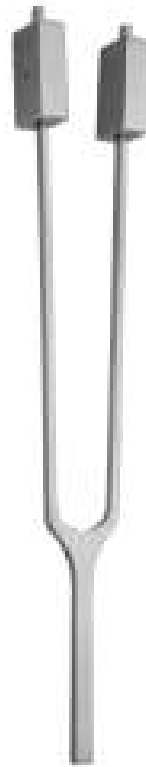
Lärmtrummerl | Aparato
Assourdisseur | Assordatore



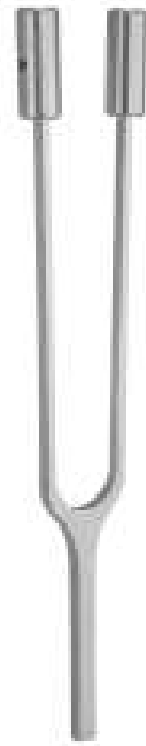
Lucas
Tuning Fork
14-105
c 128
Variable up to h (ahn, b)



Rydel-Seiffert
Tuning Fork
14-106
C 64 / c 128
With damps C 64,
Without damps c 128



French
Tuning Fork
14-107
C2 16



French
Tuning Fork
14-108
C1 32



14-109
c 128

14-110
c1 256

14-111
c2 512

14-112
c3 1024

14-113
c4 2048

14-114
c5 4096

Hartmann Tuning Fork



14-115
Hartmann tuning Forks Set case/5



14-116
c 128

14-117
c1 256

14-118
c2 512

14-119
c3 1024

14-120
c4 2048



14-121
TUNING FORKS Set in case of 5

EAR POLYPUS SNARES



Ohrpolypenschnürer

Polipátomas auriculares

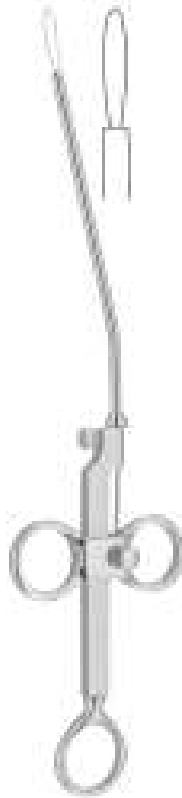
Serre nœuds auriculaires

Serranodi auricolari



Nasal Polypus Snares
14-122

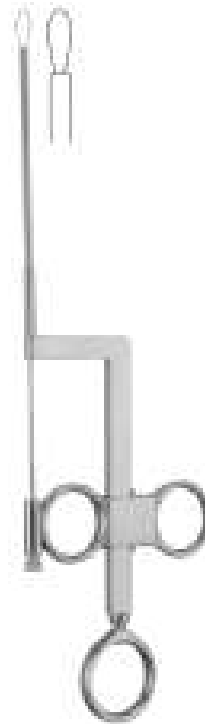
0.3 mm Ø X 100 mm
In bundles of 12 pieces



Krause Nasal Polypous Snares
14-123
25.4 cm



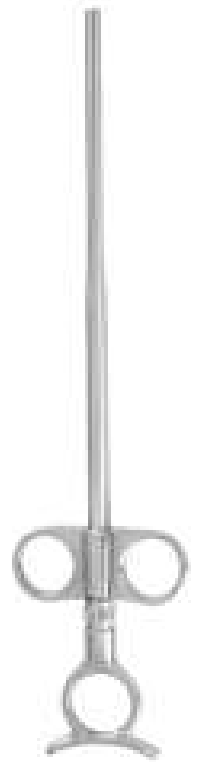
Kraus-Vosse Nasal Polypous Snares
14-124
25.4 cm
With 2 inserts



Kraus-Wilde Nasal Polypous Snares
14-125
24 cm



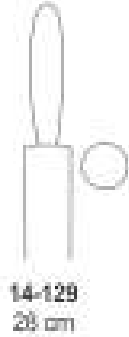
Krause
14-126
26 cm



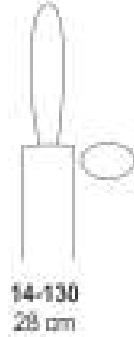
EVE Tonsil Snare
28 cm
14-127 without ratchet
14-128 with ratchet



Eves Tonsil Snare



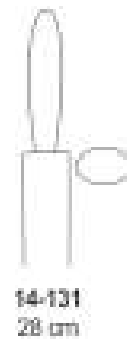
14-129
28 cm



14-130
28 cm



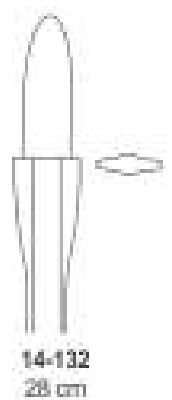
Eves Tonsil Snare



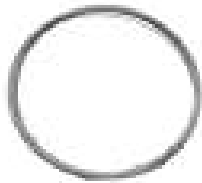
14-131
28 cm



Bruenings Tonsil Snare



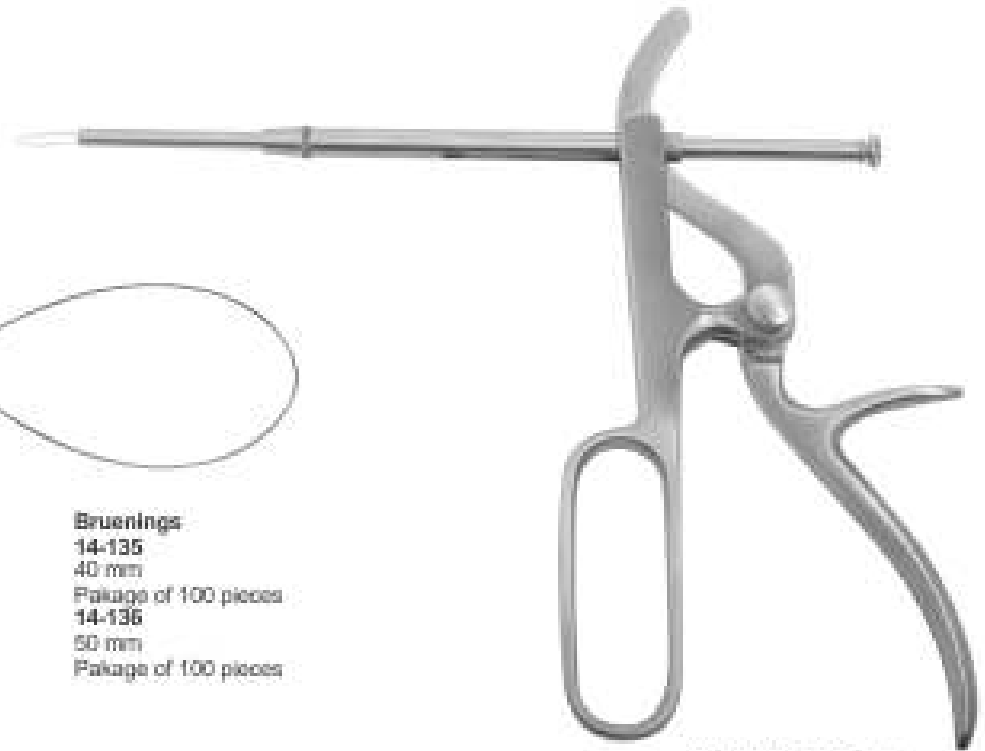
14-132
28 cm



Bruenings
14-133
10 m. 33 ft.
0.3 mm Ø
14-134
10 m. 33 ft.
0.4 mm Ø

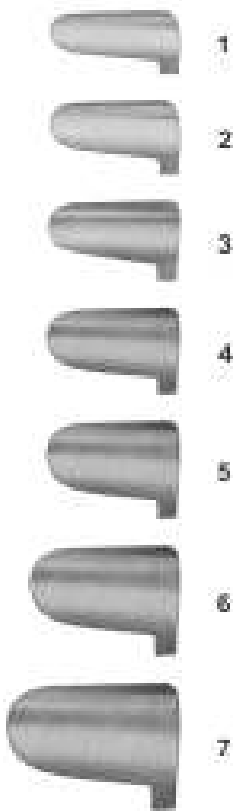


Bruenings
14-135
40 mm
Package of 100 pieces
14-136
50 mm
Package of 100 pieces

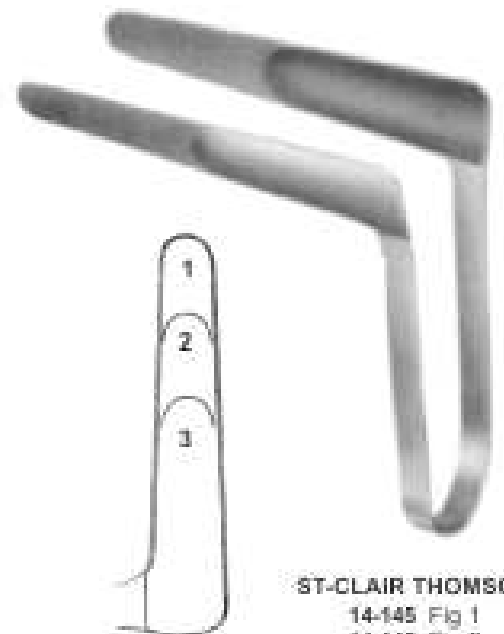


Tyding Tonsil Snare
14-137
With one straight lip

NASAL SPECULUM



Thudichum (Goldsmith) Nasal Speculum
6.5cm
14-138 Fig. 1
14-139 Fig. 2
14-140 Fig. 3
14-141 Fig. 4
14-142 Fig. 5
14-143 Fig. 6
14-144 Fig. 7



ST-CLAIR THOMSON
14-145 Fig. 1
14-146 Fig. 2
14-147 Fig. 3

NASAL SPECULUM

Nasenspekulum | Espéculo nasal
 Spéculum nasal | Speculum nasale



**Thudichum
 (Goldsmith)
 Nasal Speculum**



14-148
 6.5 cm
 21 mm X 9.5 mm



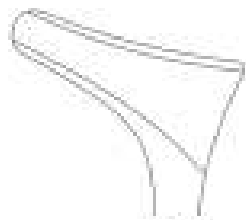
14-149
 6.5 cm
 21 mm X 10.5 mm



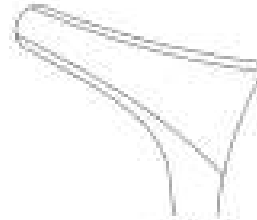
14-150
 6.5 cm
 21 mm X 11.5 mm



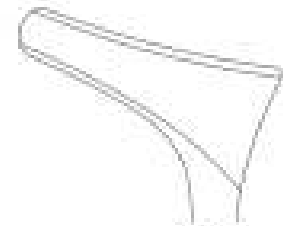
**Hartmann
 Nasal Speculum**



14-151
 16 cm
 Tip Size
 27mm



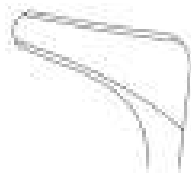
14-152
 16 cm
 Tip Size
 31mm



14-153
 16 cm
 Tip Size
 35mm



**Hartmann-Halle
 Nasal Speculum**



14-154
 15 cm



14-155
 15 cm



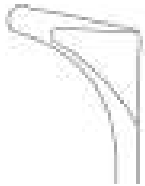
14-156
 15 cm

NASAL SPECULUM

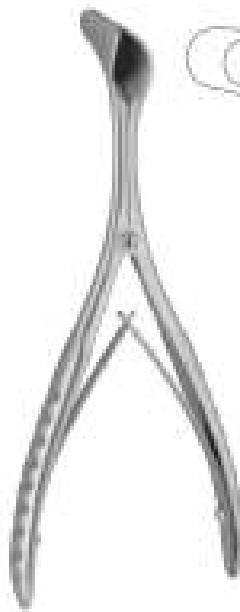
Nasenspekulum	Especulo nasal
Spékulum nasal	Speculum nasale



**Tieck-Halle
Nasal Speculum**



14-157
13.5 cm
For babies



Schwarz Nasal Speculum



14-158
14 cm



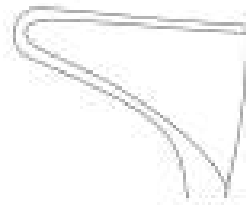
Vienna Speculum
14-159 13cm
14-160 14.6cm
medium standard pattern



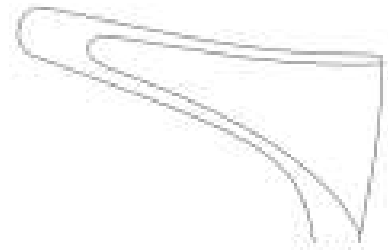
14-161
Nose Speculum,
thigh 30mm



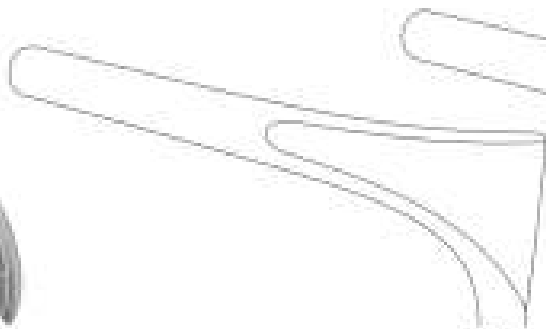
Kilian Nasal Speculum



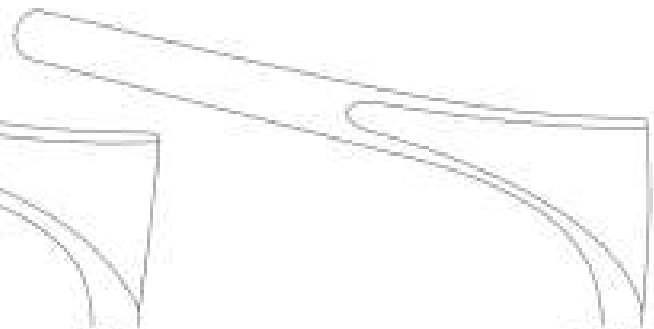
14-162
13 cm
X = 35 mm



14-163
13 cm
X = 50 mm



14-164
13 cm
X = 75 mm



14-165
13 cm
X = 90 mm

NASAL SPECULUM

Nasenspekulum
Spéculum nasal

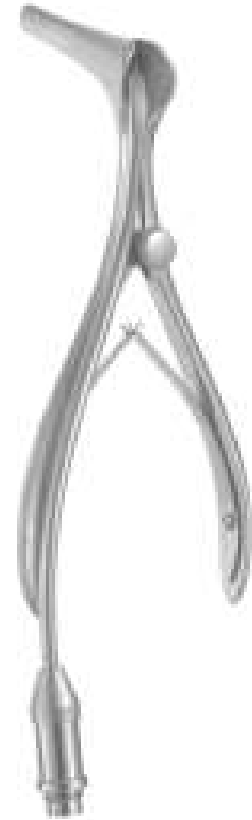
Espéculo nasal
Speculum nasale



Killian Septum Speculum
14-166
15 cm
2.51 cm blades
with set screw



Killian Septum Speculum
14-167
15 cm
8.9cm blades
set screw



Killian Septum Speculum
14-168
Fiber Optic 15 cm
length 2.51mm deep



**Beckmann
Nasal Speculum**



14-169
15 cm
25mm



14-170
15 cm
28mm



14-171
15 cm
32mm



**Mod. Wien
Nasal Speculum**



14-172
14.5 cm
25cm



14-173
14.5 cm
27cm



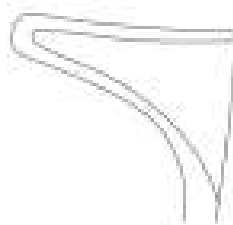
14-174
14.5 cm
30cm

NASAL SPECULUM

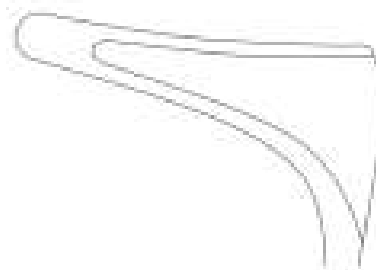
Nasenspekulum	Espéculo nasal
Spéculum nasal	Speculum nasale



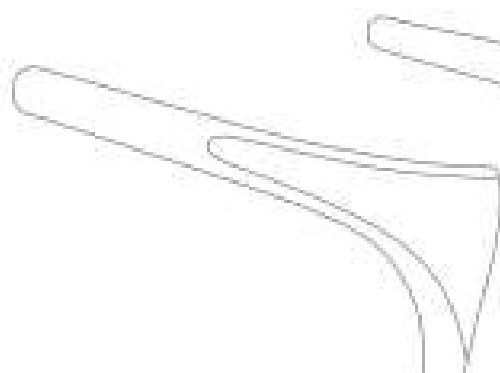
Cottle Nasal Speculum



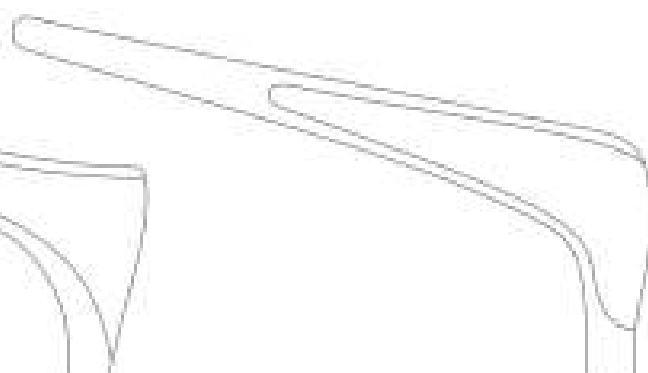
14-175
15 cm
X = 35 mm



14-176
15 cm
X = 50 mm



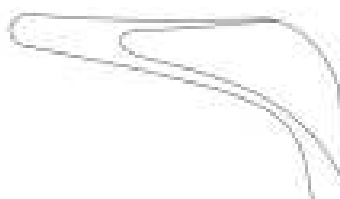
14-177
15 cm
X = 75 mm



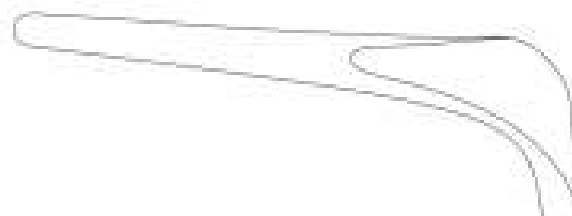
14-178
15 cm
X = 90 mm



Cottle Nasal Speculum



14-179
14 cm
X = 45 mm



14-180
14 cm
X = 75 mm

EAR CURETTES



Ohrküretten | Curetas auriculares
Curettes auriculaires | Curette auricolare

	14-181 16.5 cm 6 1/2" Blunt	14-182 16.5 cm 6 1/2" Blunt	14-183 16.5 cm 6 1/2" Blunt	14-184 16.5 cm 6 1/2" Blunt	14-185 16.5 cm 6 1/2" Blunt	14-186 16.5 cm 6 1/2" Blunt	14-187 16.5 cm 6 1/2" Blunt	14-188 16.5 cm 6 1/2" Blunt
	14-189 16.5 cm 6 1/2" Sharp	14-190 16.5 cm 6 1/2" Sharp	14-191 16.5 cm 6 1/2" Sharp	14-192 16.5 cm 6 1/2" Sharp	14-193 16.5 cm 6 1/2" Sharp	14-194 16.5 cm 6 1/2" Sharp	14-195 16.5 cm 6 1/2" Sharp	14-196 16.5 cm 6 1/2" Sharp
	14-197 16.5 cm 6 1/2" Curved, Blunt	14-198 16.5 cm 6 1/2" Curved, Blunt	14-199 16.5 cm 6 1/2" Curved, Blunt	14-200 16.5 cm 6 1/2" Curved, Blunt	14-201 16.5 cm 6 1/2" Curved, Blunt	14-202 16.5 cm 6 1/2" Curved, Blunt	14-203 16.5 cm 6 1/2" Curved, Blunt	14-204 16.5 cm 6 1/2" Curved, Blunt
	14-205 16.5 cm 6 1/2" Curved, Sharp	14-206 16.5 cm 6 1/2" Curved, Sharp	14-207 16.5 cm 6 1/2" Curved, Sharp	14-208 16.5 cm 6 1/2" Curved, Sharp	14-209 16.5 cm 6 1/2" Curved, Sharp	14-210 16.5 cm 6 1/2" Curved, Sharp	14-211 16.5 cm 6 1/2" Curved, Sharp	14-212 16.5 cm 6 1/2" Curved, Sharp

Buck, Ear
Curette

Pictures show the outer diameter

Öhrküretten und scharfe Löffel

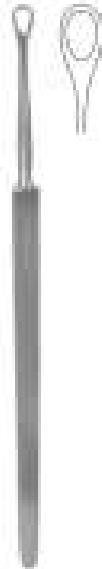
Curetas y cucharillas auriculares cortantes

Curettes auriculaires et cuillères tranchantes

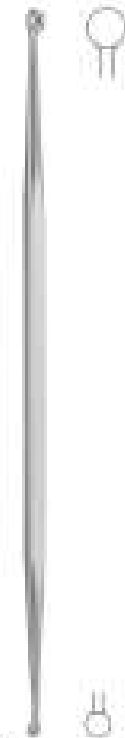
Curette auricolari e cucchiai taglienti



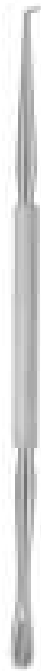
Farnell Applicator
14-213
16.5 cm 6 1/2"
cross-ribbed tip



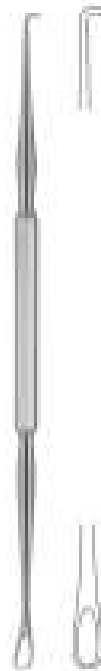
Langenbeck Ear Curette
14-214
13 cm
Blunt



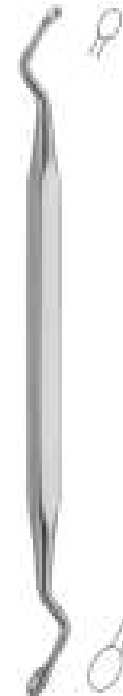
Jansen Ear Curette
14-215 15 cm
14-216 16 cm
14-217 17 cm
Sharp



Gross Ear Spoon
14-218 12 cm
Sharp, Not fenestrated



Gross Ear Curette
14-219 12 cm
Blunt, fenestrated



Gansen Ear Curette
14-220 16 cm
Sharp



Billeau Ear Loop

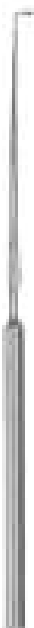
14-221
16.5 cm

14-222
16.5 cm

14-223
16.5 cm

EAR LOOPS - HOOKS

TONSIL KNIVES



Lucas Hooklet



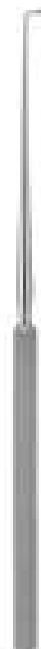
14-224
14 cm



14-225
14 cm



14-226
14 cm



Wagner Hooklet Buttoned



14-227
14 cm



14-228
14 cm



14-229
14 cm



14-230
14 cm



14-231
14 cm



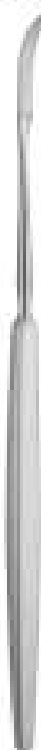
14-232
14 cm



14-233
14 cm



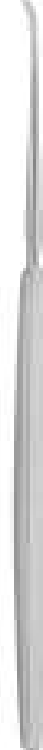
Freer Tonsil Knife
14-234
21 cm 8 1/4"



Freer Tonsil Knife
14-235
21 cm 8 1/4"



Tonsil Knife
14-236
20 cm 8"
Sharp



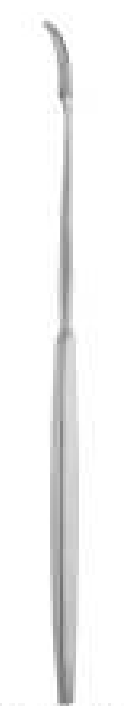
Tonsil Knife
14-237
20 cm 8"
Sickle knife

NASAL KNIVES

Nasennmesser | Cuchillos nasales
 Bistouris pour nez | Bisturi per naso



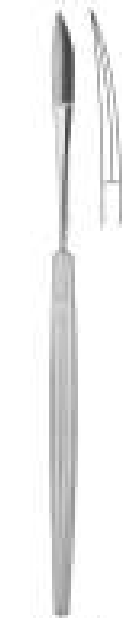
**Bruenings
Tonsil Knife**
14-238
23 cm 9"



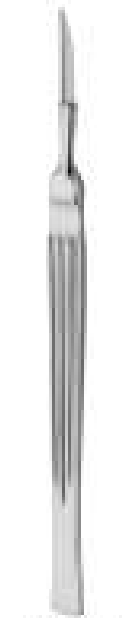
**Abraham
Tonsil Knife**
14-239
22 cm 8 3/4"



**Fischer Tonsil
Knife and Dissector**
14-240
21.5 cm 8 1/2"
semi-sharp tip, with tooth



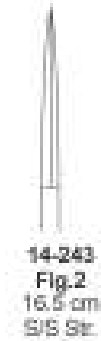
**Fomon
Nasal Knife**
14-241
16.5 cm



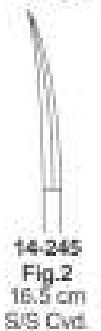
**Joseph
Nasal Knife**

14-242
Fig.1
16.5 cm
S/S Str.

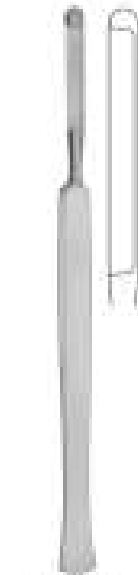
14-244
Fig.1
16.5 cm
S/S Cvd.



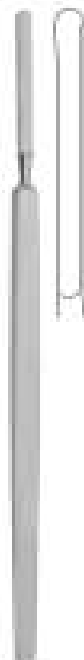
14-243
Fig.2
16.5 cm
S/S Str.



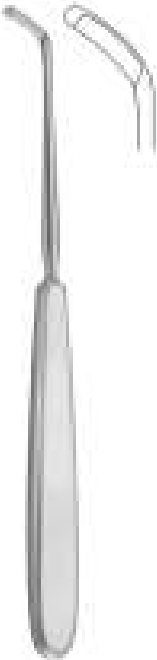
14-245
Fig.2
16.5 cm
S/S Cvd.



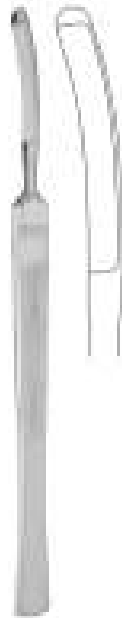
**Joseph
Nasal Knife**
14-246
14 cm



**Cottle
Nasal Knife**
14-247
15 cm



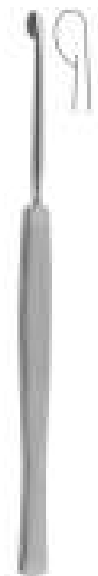
**Joseph
Nasal Knife**
14-248
17.5 cm



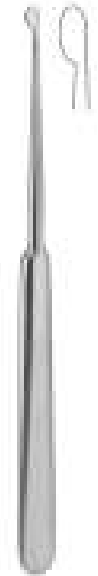
**Converse
Nasal Knife**
14-249
16 cm



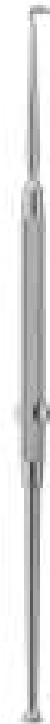
**Freer
Nasal Knife**
14-250
15 cm



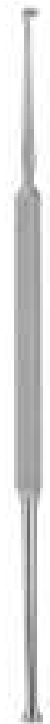
**Freer
Nasal Knife**
14-251
15 cm



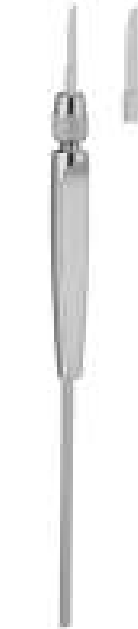
**Freer
Nasal Knife**
14-252
15 cm



**Freer
Nasal Knife**
14-253
19 cm



**Freer
Nasal Knife**
14-254
19 cm

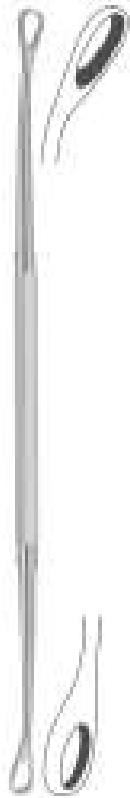


**Bruenings
Septatome**
14-255
16.5 cm
14-256
Bruenings
Spare blade

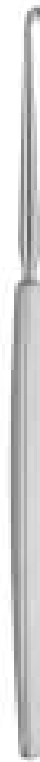
ANTRUM CURETTES

Antrumküretten | Curetas para el antrum

Curettes d'antrum | Curette per antrum



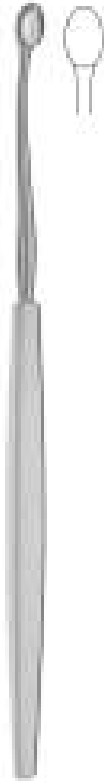
**Coakley
Antrum Curette**
14-257
21 cm



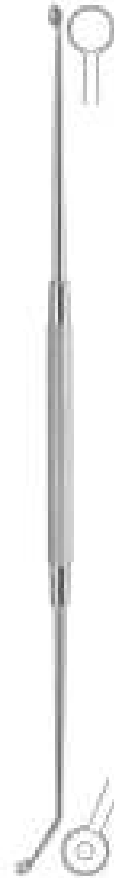
14-258
20 cm

14-259
20 cm

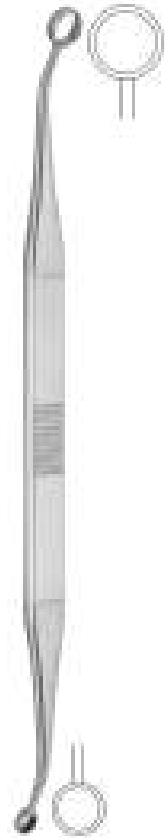
Antrum Curette



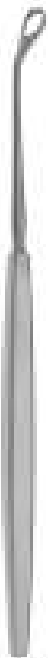
Antrum Curette
14-260
20 cm
7 mm X 11 mm



**Pratt Antrum
Curette**
14-261
21 cm



**Faulkner
Antrum Curette**
14-262
21 cm



**Coakley
Antrum Curette**



14-263
17 cm



14-264
17 cm



14-265
17 cm



14-266
17 cm



14-267
17 cm



14-268
17 cm

Antrum Curette
14-269
17 cm
Complete set



**Hypophyseal
Curette** 14-270
19cm



**Hypophyseal
Curette** 14-271
19cm

SEPTUM ELEVATORS - RASPATORIES



Septum elevatoriens - Raspatorien

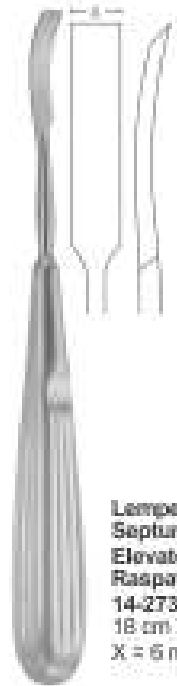
Elevadores - legros para el tabique nasal

Elevateurs - rugines pour la cloison nasale

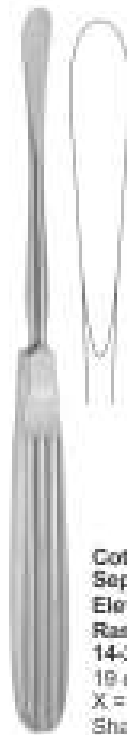
Elevatori - peristatami per setto



Lempert Septum Elevators Raspatory 14-272
20.5 cm 8"
X = 6 mm



Lempert Septum Elevators Raspatory 14-273
18 cm 7"
X = 6 mm



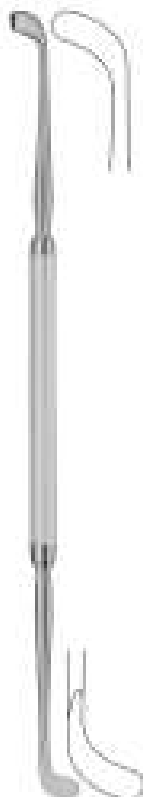
Cottle Septum Elevators Raspatory 14-274
19 cm 7 1/4"
X = 8 mm
Sharp



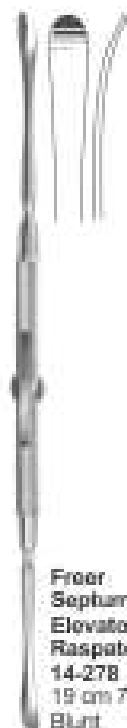
Joseph Septum Elevators Raspatory 14-275
16 cm 6 1/4"
X = 5 mm
Pericostal elevators



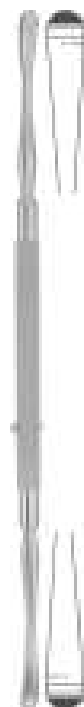
Joseph-Masing Septum Elevators Raspatory 14-276
21.5 cm 8 1/2"
Sharp



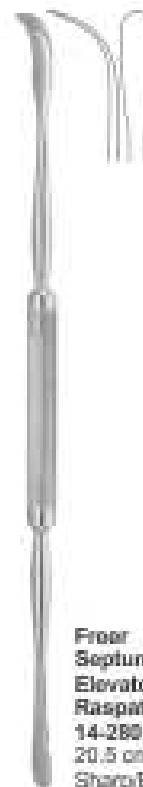
Pennington Septum Elevators Raspatory 14-277
21.5 cm 8 1/2"
Blunt



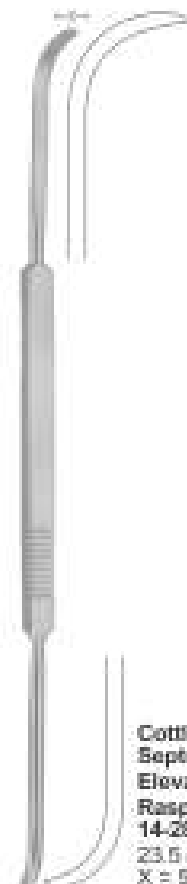
Froer Septum Elevators Raspatory 14-278
19 cm 7 1/2"
Blunt



Froer Septum Elevators Raspatory 14-279
18 cm 7"
Sharp/Blunt



Froer Septum Elevators Raspatory 14-280
20.5 cm 8"
Sharp/Blunt



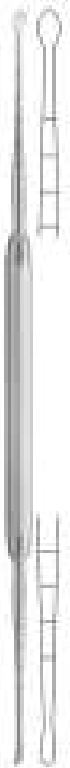
Cottle Septum Elevators Raspatory 14-281
23.5 cm 9 1/4"
X = 5 mm
Sharp

levatori, Septumlevatori

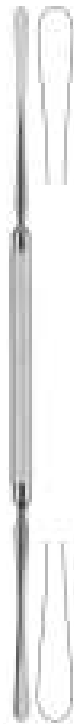
Legras para periostio, Elevadores para el tabique nasal

ars pour la perioste, Elevateurs pour la cloison nasale

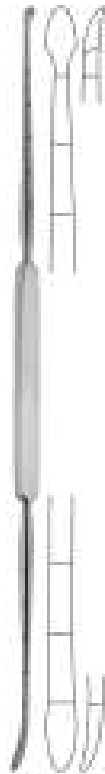
Elevatori per il periostio, Elevatori per setto



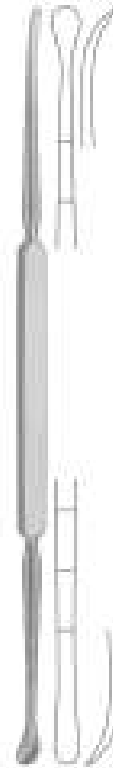
Masing Periosteal Septum Elevators
14-282 20 cm 8"



Ballenger-Hajek Periosteal Septum Elevators
14-283 19 cm 7 1/4"
14-284 22 cm 8 3/4"



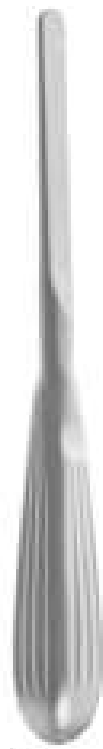
Cottle Periosteal Septum Elevators
14-285 22 cm 8 3/4"



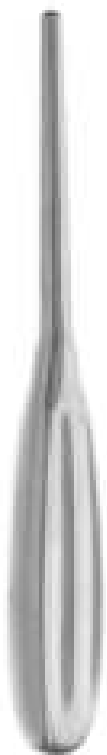
Cottle Periosteal Septum Elevators
14-286 21 cm 8 1/4"



Watson-Cheyne
13 cm 5" Respatory



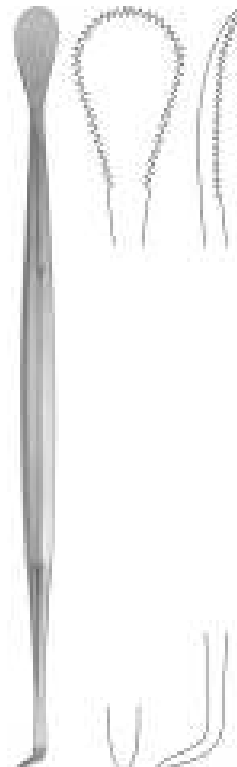
Boies
14-289 19 cm 7 5/8"
Nasal fracture elevator, Blunt



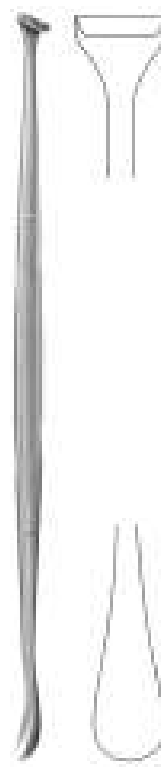
Goldman
14-290 17 cm 6 3/4"
Septum displacer



Henke Tonsil Dissector
14-291 23 cm



Henke Tonsil Dissector
14-292 23 cm



Hurd Tonsil Dissector
14-293 22 cm



Carpenter Enucleator
14-294 28 cm

Nasensågen / Felle

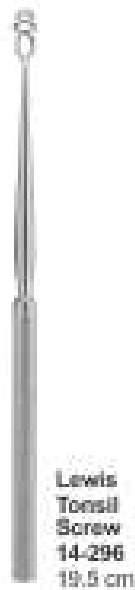
Sierras nasales / archiuo

Scies nasales / Lima

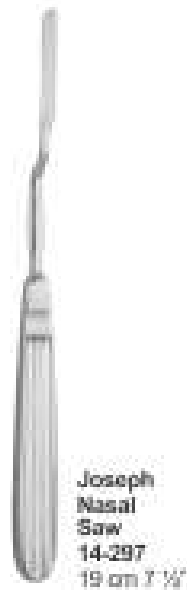
Seghe / file nasal



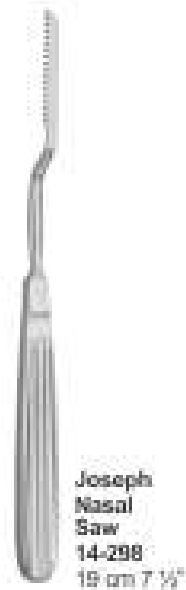
**Luniatshok
Tonsil
Tampon
Plugger**
14-295
19 cm



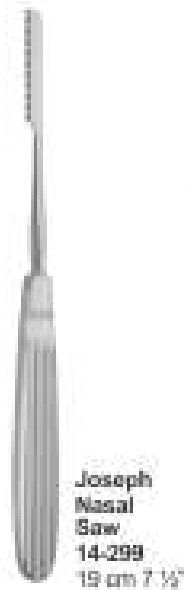
**Lewis
Tonsil
Screw**
14-296
19.5 cm



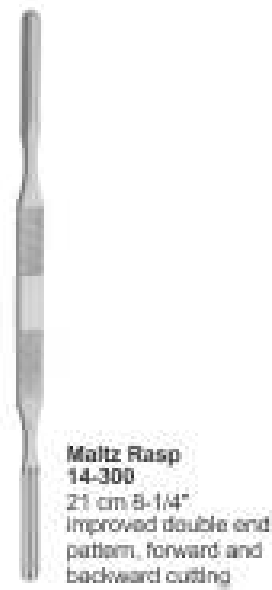
**Joseph
Nasal
Saw**
14-297
19 cm 7 1/4"



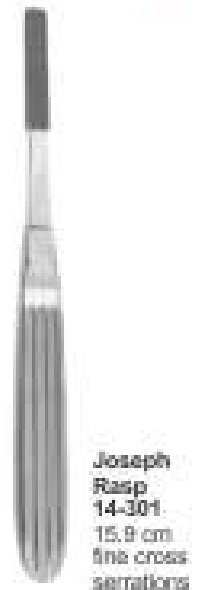
**Joseph
Nasal
Saw**
14-298
19 cm 7 1/4"



**Joseph
Nasal
Saw**
14-299
19 cm 7 1/4"



Maltz Rasp
14-300
21 cm 8-1/4"
Improved double end
pattern, forward and
backward cutting



**Joseph
Rasp**
14-301
15.9 cm
fine cross
serrations

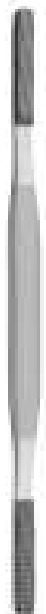


Joseph Nasal Saw
14-302
17 cm 6 3/4"



Joseph Nasal Saw
14-303
17 cm 6 3/4"

RASPS WITH TUNGSTEN CARBIDE



**Formon Rasp
with Tungsten
Carbide TC**
20cm 8"



Teeth 12
Teeth 14

14-304



Teeth 16
Teeth 20

14-305



Teeth 24
Teeth 30

14-306



Teeth 38
Teeth 44

14-307



Teeth 52
Teeth 82

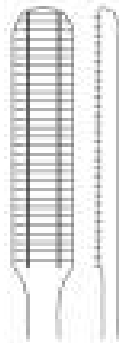
14-308



Cottle Nasal Saw
14-309
21 cm 8 1/4"



Maltz Nasal Saw



14-310
17 cm 6 3/4"
34 mm x 7 mm
Pushing cut



14-311
17 cm 6 3/4"
34 mm x 7 mm
Drawing cut



Aufricht Nasal Saw
Gabella Rasp,
backward cutting



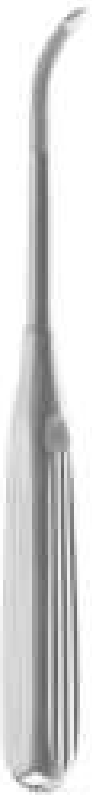
14-312
21 cm 8 1/4"
Pushing cut



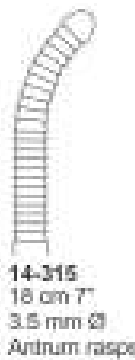
14-313
21 cm 8 1/4"
Drawing cut



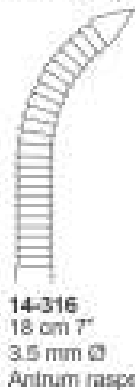
14-314
17.5 cm 7"
40 mm X 9 mm



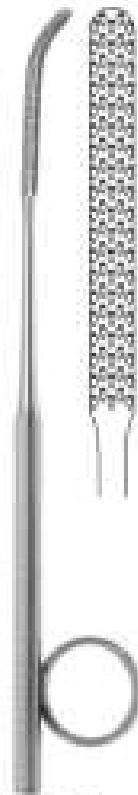
Wiener Nasal Saw



14-315
18 cm 7"
3.5 mm Ø
Antrum rasps



14-316
18 cm 7"
3.5 mm Ø
Antrum rasps



Gallaher Nasal Saw



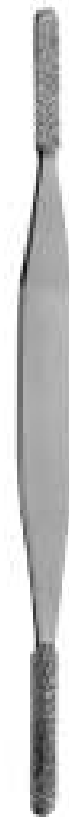
14-317
18 cm 6 1/4"



14-318
18 cm 6 1/4"



14-319
18 cm 6 1/4"



Fomon Nasal Saw
14-320
21 cm 8 1/4"



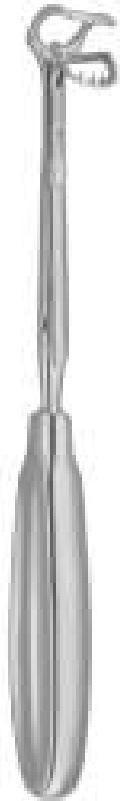
RINGMESSER

adenoid curettes

Cuchillos para vegetaciones adenoides

Couteaux à végétations adénoïdes

Adenotomi



14-321
21 cm 8 1/4"



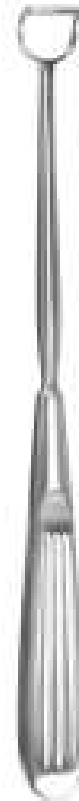
14-322
21 cm 8 1/4"



14-323
21 cm 8 1/4"



14-324
21 cm 8 1/4"



14-325
22 cm 8 3/4"



14-326
22 cm 8 3/4"



14-327
22 cm 8 3/4"



14-328
22 cm 8 3/4"

St. Clair-Thomson
Adenoid Curette

Barnhill
Adenoid Curette



14-329
22 cm 8 3/4"
Straight



14-330
22 cm 8 3/4"
Straight



14-331
22 cm 8 3/4"
Straight



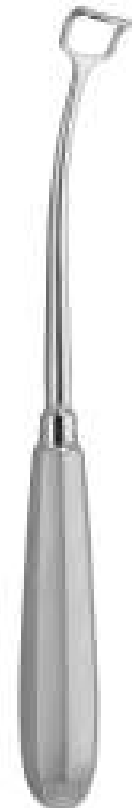
14-332
22 cm 8 3/4"
Straight



14-333
22 cm 8 3/4"
Straight



14-334
22 cm 8 3/4"
Straight



14-335
22 cm 8 3/4"
Curved



14-336
22 cm 8 3/4"
Curved



14-337
22 cm 8 3/4"
Curved



14-338
22 cm 8 3/4"
Curved



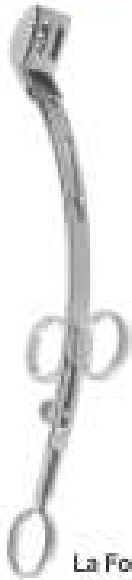
14-339
22 cm 8 3/4"
Curved



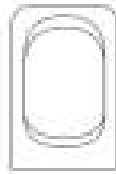
14-340
22 cm 8 3/4"
Curved

Beckmann
Adenoid Curette

Beckman
Adenoid Curette



La Force



La Force
adenotome
unperforated
Fig 1
14-341
21.5 cm 8 1/2"
25 x 16.0mm
Infant



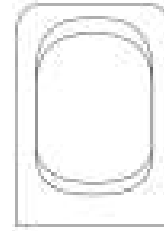
La Force
adenotome
perforated
Fig 1
14-342
21.5 cm 8 1/2"
25 x 16.0mm
Infant



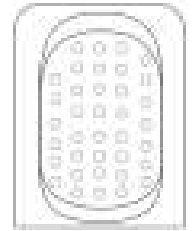
La Force
adenotome
unperforated
Fig 2
14-343
24.1 cm 9 1/2"
26 x 19.3mm
Medium



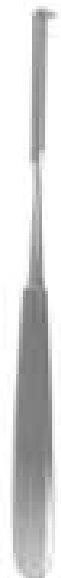
La Force
adenotome
perforated
Fig 2
14-344
24.1 cm 9 1/2"
26 x 19.3mm
Medium



La Force
adenotome
unperforated
Fig 3
14-345
25 cm 10"
30 x 22.2mm
Large



La Force
adenotome
perforated
Fig 3
14-346
25 cm 10"
30 x 22.2mm
Large



14-347
20 cm 8"
X = 3 mm
Straight

Ballenger Knife



14-348
20 cm 8"
Straight
X = 4 mm

Ballenger Knife



14-349
20 cm 8"
X = 5 mm
Straight

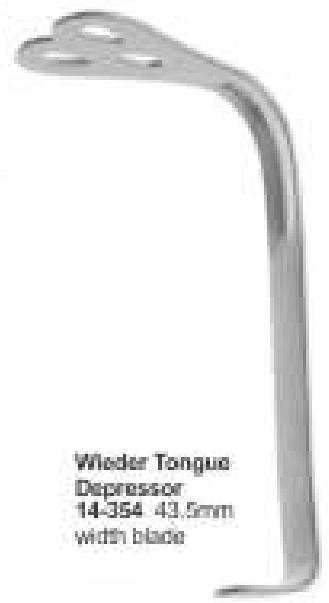
14-350
20 cm 8"
X = 3 mm
Bayonet

14-351
20 cm 8"
Bayonet
X = 4 mm

14-352
20 cm 8"
X = 5 mm
Bayonet



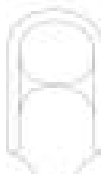
Wieder Tongue Depressor
14-353 large blade 36mm
wide serrated



Wieder Tongue
Depressor
14-354 43.5mm
width blade



Blade
Fig 1
14-355



Blade
Fig 2
14-356



Blade
Fig 3
14-357

Sluder-Ballenger Tonsil
Guillotines &
Punch Forceps
14-358
complete set with 3 blades

Sluder-Ballenger Tonsil
Guillotines & Punch Forceps
Handle
14-359 Handle



14-360
X = 12 cm
13 mm Ø



14-361
X = 15 cm
13 mm Ø



14-362
X = 17 cm
13 mm Ø

Hartmann Tonsil Guillotines
& Punch Forceps



NASAL POLYPUS AND SEPTUM FORCEPS

Nasenpolypenzangen-Septumzangen | Pinzas para pólipos y el tabique nasal
Pincès à polypes et la cloison nasale | Pinze per polipi e setto nasale



Westmacott Nasal Polypus and Septum Forceps
14-363 20 cm 8"



Lubet-Barbon Nasal Polypus and Septum Forceps
14-364 20 cm 8"



Hartmann Nasal Polypus and Septum Forceps
14-365 16 cm 6 1/4"
14-366 20 cm 8"



Tilley Nasal Polypus and Septum Forceps
14-367 14 cm 5 1/2"



Heymann-Knight Nasal Polypus and Septum Forceps
14-368 18 cm 7"



Craig Nasal Polypus and Septum Forceps
14-369 18 cm 7"



Knight Nasal Polypus and Septum Forceps
14-370 18 cm 7"



Littauer Nasal Polypus and Septum Forceps
14-371 18 cm 7"

EAR POLYPUS FORCEPS

Ohrpolypenzangen

Pinças para pólipos auriculares

Pinces pour polypes auriculaires

Pinze per polipi auricolari



**Littauer Ear
Polypus Forceps
14-372**
12 cm 4 3/4"



**Hartmann Ear
Polypus Forceps
14-373**
12 cm 4 3/4"
Delicate jaw



**Hartmann Ear
Polypus Forceps
14-374**
14 cm 5 1/2"
Normal jaw



**Quine Ear
Polypus Forceps
14-375**
10.5 cm 4 1/4"
Foreign body lever



**Buck Ear
Polypus Forceps
14-376**
11.5 cm 4 1/2"
Foreign body forceps



**Wide Nasal
Dressing Forceps
14-377**
16.5cm 6 1/2"
angular

TONSIL INSTRUMENTS



**Troeltsch
Dressing Forceps
14-378**
11cm, 4 1/2"



**Troeltsch
Dressing Forceps
14-379**
13 cm, 5"



**Lucas Dressing
Forceps
14-380**
14 cm, 5 1/2"



**Janson Dressing
Forceps
14-381**
16 cm, 6 1/2"

Nasal Polypus & Nasal Dressing Forceps

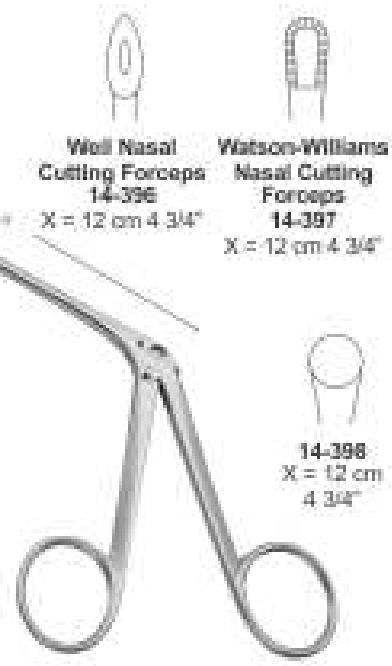
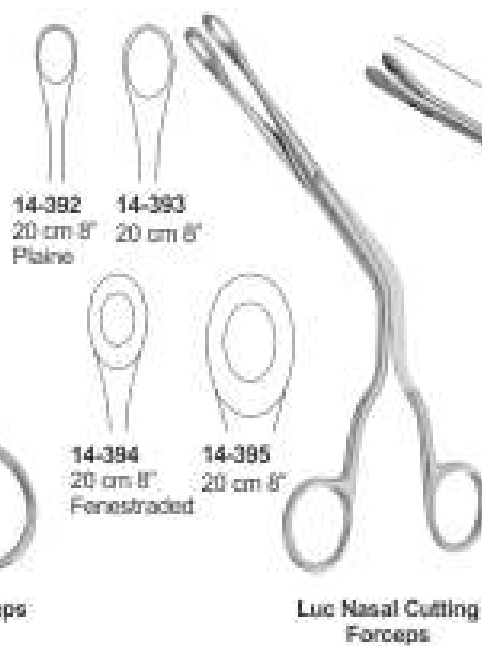
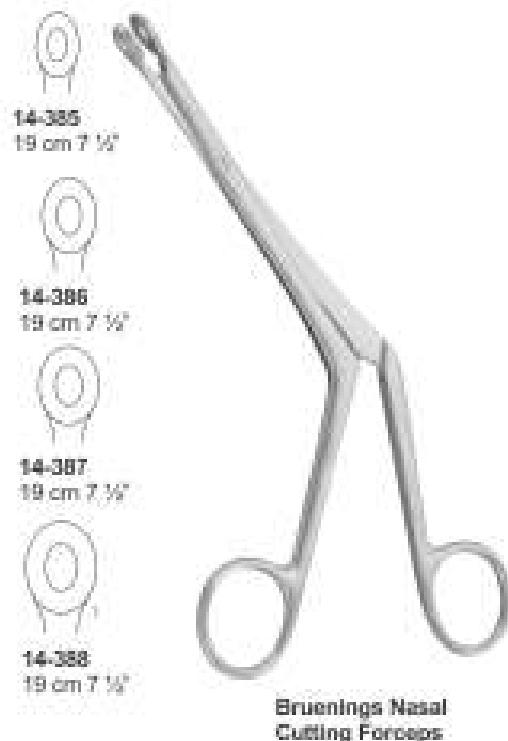
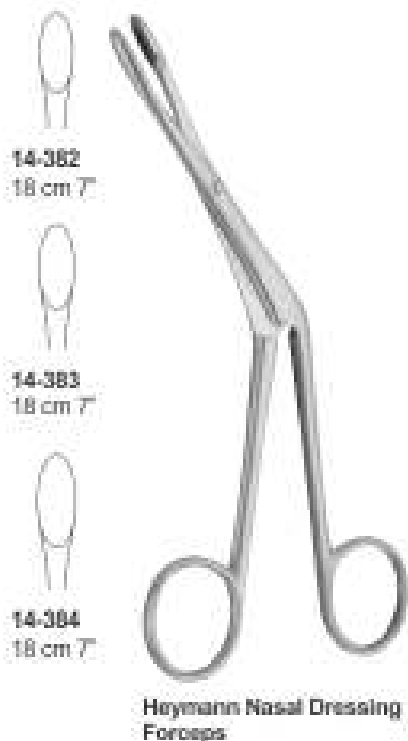












Nasenpolypenzangen, Nasentamponzange

Pinças para pólipos nasales, Pinças nasale para tamponamento

Pinces à polypes nasales, Pinces à pansement pour le nez









Pinze per polipi nasali, Pinze per tamponamento



	X = 12 cm	 14-399 a - 3.0 mm	 14-400 a - 3.5 mm	 14-401 a - 4.5 mm	 14-402 a - 5.0 mm	 14-403 a - 5.5 mm
	X = 12 cm	14-404 a - 3.0 mm	14-405 a - 3.5 mm	14-406 a - 4.5 mm	14-407 a - 5.0 mm	
	X = 12 cm	14-408 a - 3.0 mm	14-409 a - 3.5 mm	14-410 a - 4.5 mm		
	X = 18 cm	14-411 a - 3.0 mm	14-412 a - 3.5 mm	14-413 a - 4.5 mm	14-414 a - 5.0 mm	14-415 a - 5.5 mm
	X = 18 cm	14-416 a - 3.0 mm	14-417 a - 3.5 mm	14-418 a - 4.5 mm	14-419 a - 5.0 mm	



**Weil-Blakesley
Nasal Cutting Forceps**

	14-420 X = 12 cm		14-421 X = 12 cm		14-422 X = 12 cm		14-423 X = 12 cm
	Myles Nasal Cutting Forceps		14-424 X = 12 cm 2.0 mm X 10 mm		14-425 X = 12 cm 2.5 mm X 12 mm		14-426 X = 12 cm 3 mm X 14 mm



**Hartmann Nasal
Cutting Forceps**

PUNCHES SPHENOID BONE

Keribeinstanzen

Pinzas para esfenoides

Pinces pour le sinus sphenoidal

Pinze sfenoidali taglianti



1.5 mm

2.2 mm

3.0 mm

Citelli Bone Ear Rongeurs
14-427 17 cm 6 3/4"
X = 60 mm



3 X 3 mm

4 X 4 mm

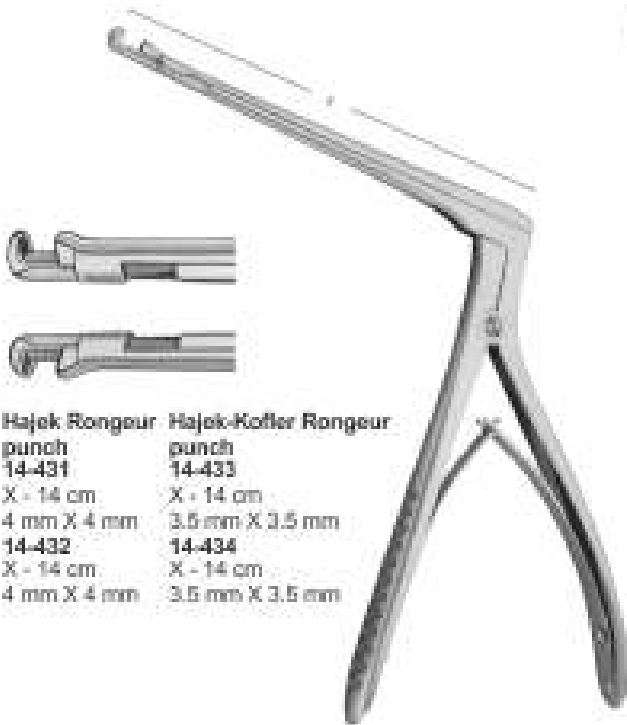
5 X 5 mm

6 X 6 mm

Kerrison Bone Ear Rongeurs
14-428 20 cm 8"
X = 80 mm



Beyer Bone Ear Rongeurs
14-429 14 cm 1 mm
14-430 19 cm 2 mm



Hajek Rongeur punch
14-431

X - 14 cm
4 mm X 4 mm

14-432

X - 14 cm
4 mm X 4 mm

Hajek-Kofler Rongeur punch
14-433

X - 14 cm
3.5 mm X 3.5 mm

14-434

X - 14 cm
3.5 mm X 3.5 mm



Hajek-Claus Rongeur punch
14-435 20 cm



Hajek-Kofler Rongeur punch
14-436
X - 18 cm
3.5 mm
Shaft rotates 360°

Septuminstrumente
instruments pour la cloison nasale

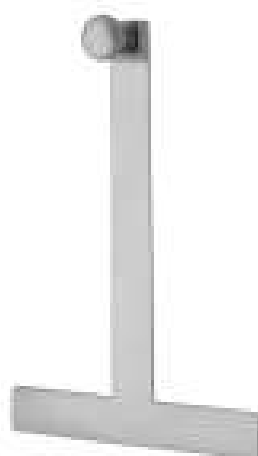
Instrumentos para el tabique nasal
Strumenti per il setto nasale



Bruenings-Brunk
14-437
19 cm 7 1/2"
Antrum Retractor
Serrated



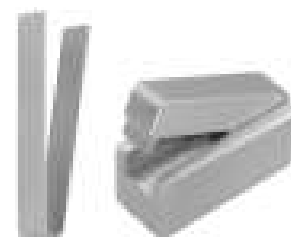
Ritter-Halle
14-438 16 cm 6 1/4"
2.5 mm Ø
14-439 16 cm 6 1/4"
3.0 mm Ø
14-440 16 cm 6 1/4"
4.0 mm Ø
Fontal sinus bougies



Cottle
14-441
1.2 cm 4 3/4"
Handle



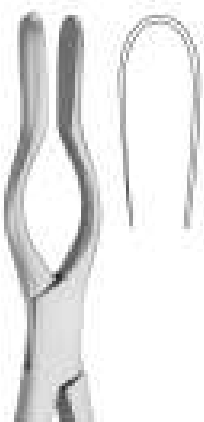
Cottle
14-442
7 mm
Guide support
for osteotomes



Cottle
14-443
65 mm X 30 mm X 30 mm
Cartilage crusher



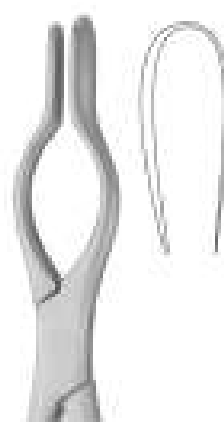
Cottle-Walsham
Septum Forceps



14-444
23 cm 9"
Straight



14-445
23 cm 9"
Left



14-446
23 cm 9"
Right



Ash Septum
Forceps
14-447
23 cm 9"

SEPTUM FORCEPS

Septumzangen

Pinzas para el tabique nasal

Pinces pour la cloison nasale

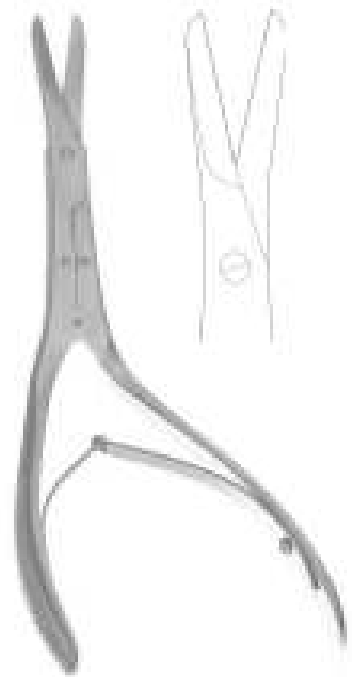
Pinze per il setto nasale



**Middleton-Jansen
Septum Forceps**
14-448 19 cm



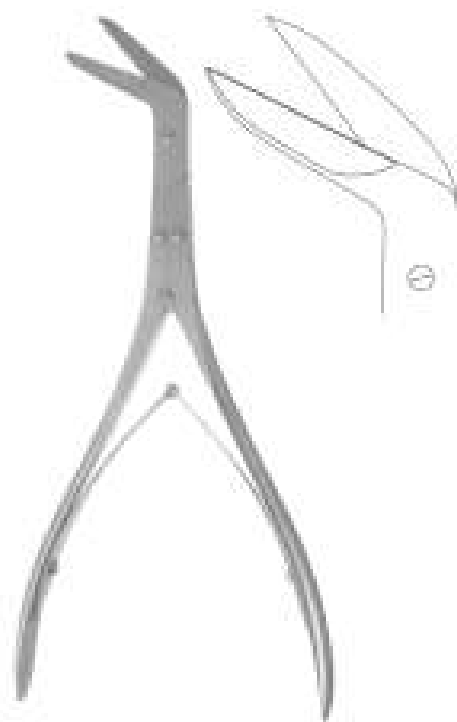
**Middleton-Jansen
Septum Forceps**
14-449 19 cm



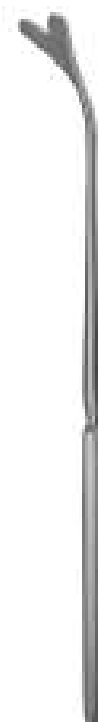
**Caplan Septum
Forceps**
14-450 20 cm
Toothed



**Rubin Septum
Forceps**
14-451
21 cm
Protection cap



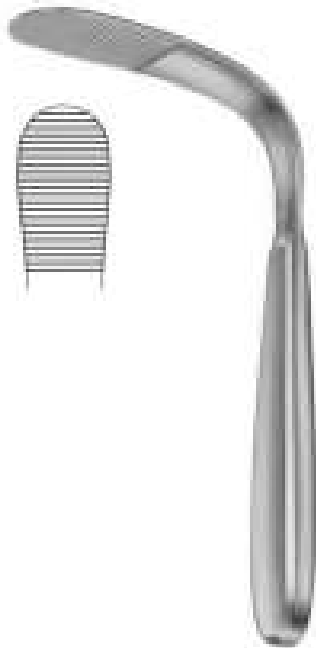
Killian
14-452
20 cm
Laryngotomy scissors



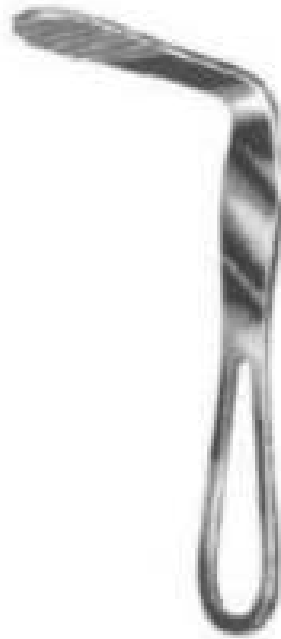
**Reichert Epiglottis
Retractor**
14-453
23 cm



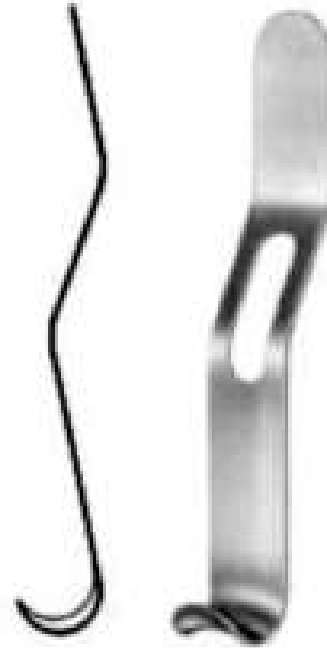
**Aufrecht Retractor
Speculum**
14-454
16.5cm
solid blade



Tobold
14-455
Tongue Depressor
14.5 cm



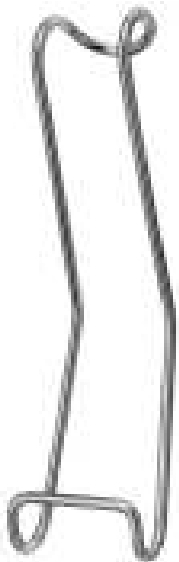
Hartmann
14-456
15 cm



Cheek Retractor
14-457
14.5 cm



Cawood-Minnesota
14-458
Cheek Retractor
15 cm



Stenberg
14-459
Lip and Cheek Retractor
14 cm



Obwegeser
14-460
Cheek Retractor
12 cm



Vestibulum Retractor
14-461
14 cm



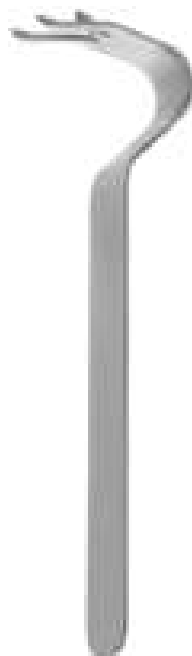
Oringer
Lip and Cheek Retractor
14-462 9.5cm
14-463 10 cm
14-464 10.5cm
14-465 11 cm

SPATULA, RETRACTORS

Spachtel, Retraktoren | *Espátula, retractores*
Spatule, écarteurs | *Spatola, divaricatori*



Obwegeser
14-466
Channel Retractor
17 cm



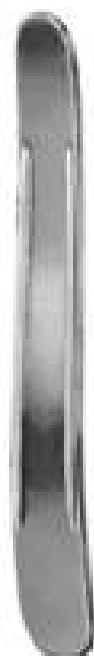
Obwegeser
14-467
Chin Retractor
15.5 cm



Retractor
14-468
18.5 cm



Tongue Spatula
14-469
16 cm



Martin
14-470
Tongue Spatula
18.5 cm



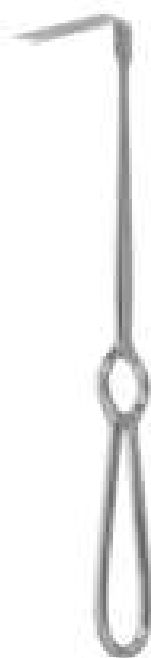
Haberer flexible
Abdominal and Intestinal
14-471
spatulas 33cm (40mm)



Bruenings Tongue
Depressors
14-472
19 cm



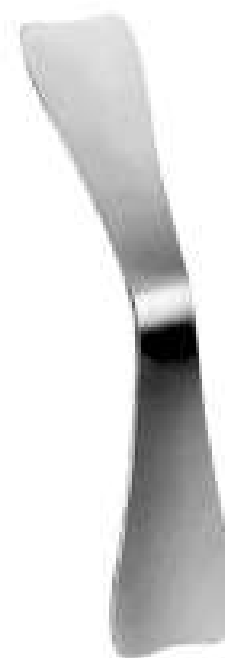
Obwegeser
14-473
Soft Tissue Retractor
21.5 cm



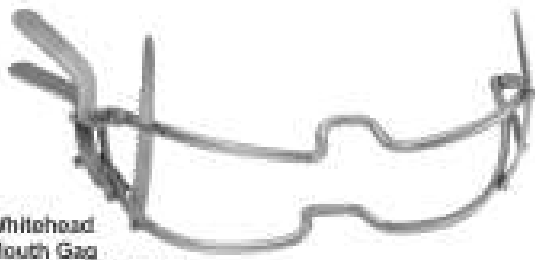
Obwegeser
14-474
Nasal Spine Retractor
22 cm



Obwegeser
14-475
Ramus Retractor
22 cm



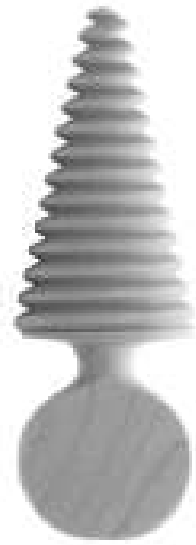
Doyen
14-476
Tongue Spatula
13.5 cm



**Whitehead
Mouth Gag**
14-477 11 cm 4 1/4"
14-478 13 cm 5"
14-479 15 cm 6"



**Hoister
Mouth Gag**
14-484
13 cm 5"



**Mauler
Mouth Gag**
14-485
10 cm 4"
4 mm Ø
Wood



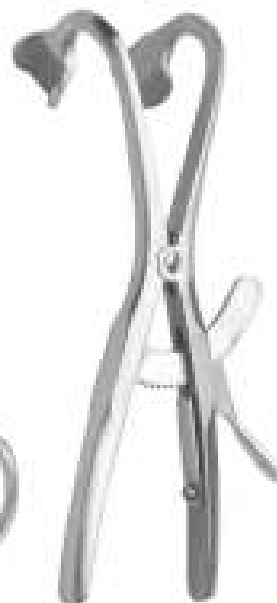
**Jennings
Mouth Gag**
14-480 9 cm 3 1/2"
14-481 11 cm 4 1/4"
14-482 13 cm 5"
14-483 15 cm 6"



Molt Mouth Gag
14-486
11 cm 4 1/4"
For children



Molt Mouth Gag
14-487
14 cm 5 1/2"
For adults



**Denhart
Mouth Gag**
14-488
12 cm 4 3/4"



**Fergusson-Ackland
Mouth Gag**
14-489
14.5 cm 5 3/4"



**Roser-Konig
Mouth Gag**
14-490
16 cm 6 1/4"
14-491
19 cm 7 1/2"

MOUTH GAGS

Mundsperrer | Abreboças
 Ouure-bouches | Apribocca



**Dingmann Cleft Palate
 Repair Mouth Gag**
 14-492
 14.5 cm



**14-493
 Mouth Gag
 Blade**
 55 mm X 25 mm



**14-494
 Mouth Gag
 Blade**
 60 mm X 27 mm



**14-495
 Mouth Gag
 Blade**
 70 mm X 30 mm



Kilner-doughty Mouth Gag
 14-496

Complete with frame, 3 tongue depressors and 2 adjustable lateral blades

**14-497
 Mouth Gag
 Blade**
 28 mm X 65 mm

**14-498
 Mouth Gag
 Blade**
 32 mm X 75 mm

**14-499
 Mouth Gag
 Blade**
 37 mm X 80 mm

**14-500
 Mouth Gag
 Blade**
 40 mm X 90 mm

**14-501
 Mouth Gag
 Blade**
 45 mm X 100 mm

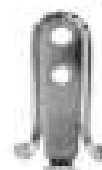
**Complete Kilner-doughty
 Mouth Gag Set With 3 Blades**
 14-502



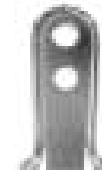
**Kilner-Doughty Mouth
 Gag Handle**
 14-503



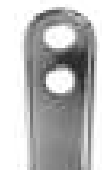
**Negus Mouth
 Gag Complete
 Set**
 14-504



**14-505
 Mouth Gag
 Blade**
 20X70mm



**14-506
 Mouth Gag
 Blade**
 30X80mm



**14-507
 Mouth Gag
 Blade**
 33X95mm



**Negus Mouth
 Gag Handle**
 14-508

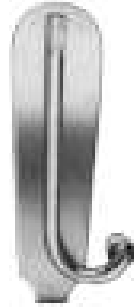
**Davis-boyle Mouth
Gag Complete Set
with five blades
14-509**



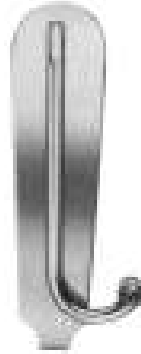
**14-510
Mouth Gag
Blade**
20 mm X 26 mm



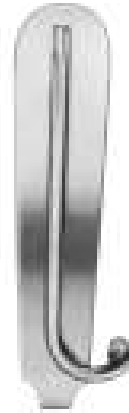
**14-511
Mouth Gag
Blade**
23 mm X 65 mm



**14-512
Mouth Gag
Blade**
24 mm X 80 mm



**14-513
Mouth Gag
Blade**
25 mm X 93 mm



**14-514
Mouth Gag
Blade**
26 mm X 108 mm



**Davis-Boyle
Mouth Gag
Handle
14-515**



**14-517
Mouth Gag Blade**
23 mm X 70 mm



**14-518
Mouth Gag Blade**
25 mm X 86 mm

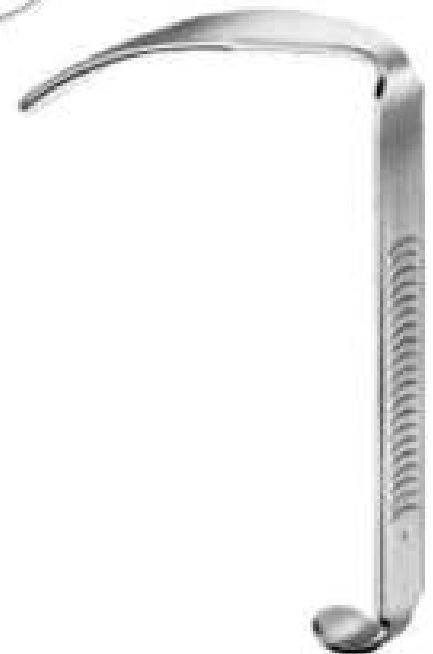


**14-519
Mouth Gag Blade**
26 mm X 100 mm



**McLvor Mouth Gag
Handle
14-520**

**McLvor Mouth Gag
Complete Set
14-516**



**Roser-Knig
14-521
Mouth Gag
13.5 cm**

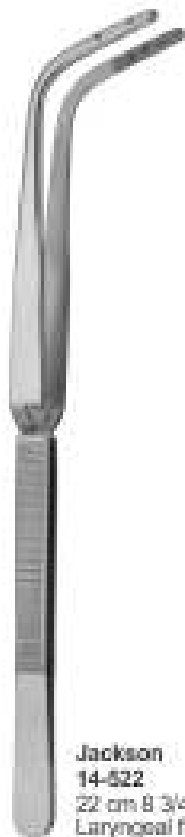
TONSIL INSTRUMENTS

Tonsilleninstrumente

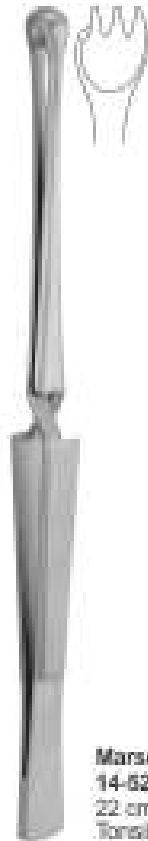
Instrumentos para amígdalas

Instrumente pour amygdales

Strumenti per tonsille



Jackson
14-522
22 cm 8 3/4"
Laryngeal forceps



Marschik
14-523
22 cm 8 3/4"
Tonsil seizing forceps



Blohmke
Tonsil
Forceps
14-524
20 cm 8"



6 X 5

Colver Tonsil
Forceps
14-525
19 cm 7 1/2"
Straight
14-526
19 cm 7 1/2"
Curved



6 X 5

White Tonsil
Seizing Forceps
14-527
19.1 cm 7 1/2"
14-528
23 cm 9"



Museum
Tonsil Holding Forceps
14-529 20 cm 8"

LARYNGEAL MIRRORS

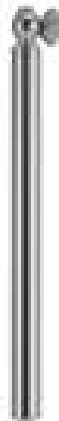
Kehlkopfspiegel
Mirrors laryngiens

Especjos laringeos
Specchi laringei



- 14-530 8 mm Ø
- 14-531 10 mm Ø
- 14-532 12 mm Ø
- 14-533 14 mm Ø
- 14-534 16 mm Ø
- 14-535 18 mm Ø
- 14-536 20 mm Ø
- 14-537 22 mm Ø
- 14-538 24 mm Ø
- 14-539 26 mm Ø
- 14-540 28 mm Ø
- 14-541 30 mm Ø

Laryngeal mirrors



Laryngeal Mirrors
Handle
14-541
10 cm



- 14-542 8 mm Ø
- 14-543 10 mm Ø
- 14-544 12 mm Ø
- 14-545 14 mm Ø
- 14-546 16 mm Ø
- 14-547 18 mm Ø
- 14-548 20 mm Ø
- 14-549 22 mm Ø
- 14-550 24 mm Ø
- 14-551 26 mm Ø
- 14-552 28 mm Ø
- 14-553 30 mm Ø

Laryngeal Mirrors
with Handle



- 14-554 10 mm Ø
- 14-555 12 mm Ø
- 14-556 14 mm Ø
- 14-557 16 mm Ø
- 14-558 18 mm Ø

Michel Moveable
Mirror

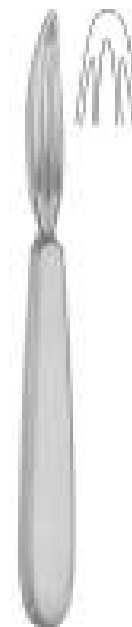
GOITRE GRASPING FORCEPS - GOITRE ENUCLEATOR



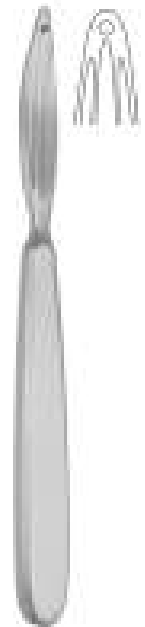
Mastin Goitre
Grasping Forceps
14-559
17 cm



Lahey Goitre
Grasping Forceps
14-560 15 cm
14-561 20 cm



Kocher Goitre
Enucleator
14-562
16 cm



Kocher Goitre
Enucleator
14-563
16 cm
With Hole

TRACHEA DILATORS, TRACHEA TUBES

Trachealdilatatoren, Trachealkanülen

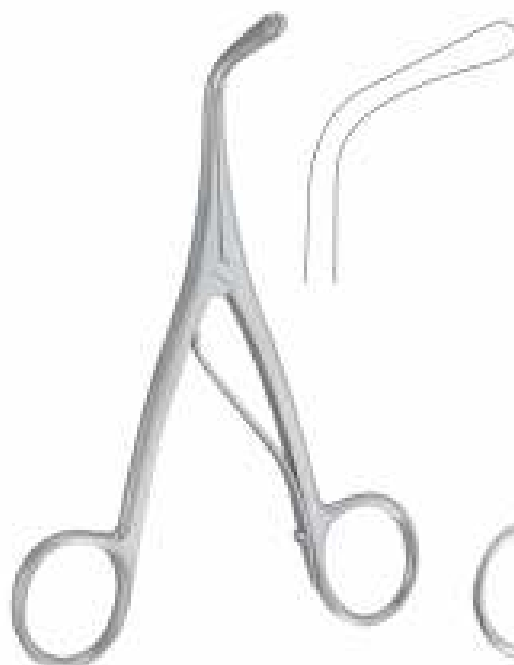
Dilatateurs pour la trachéotomie, Canules pour la trachéotomie

Dilatadores para la traqueotomía, Cábbykas para

Dilatatori traheali, Cábbyke traheali



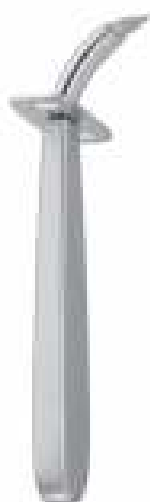
Laborde Trachea Dilator 3 Prong
14-564 14 cm



Trousseau Trachea Dilator 2 Prong
14-565 14 cm



Bowby Trousseau Tracheal Dilator Bowby Paediatric
14-566 15.5 cm



Uickermann Trachea Tubes
14-567
13 cm
10 mm Ø



Luer-Standard Trachea Tubes
German silver

14-568 4 mm Ø
14-569 5 mm Ø
14-570 6 mm Ø
14-571 7 mm Ø
14-572 8 mm Ø
14-573 9 mm Ø
14-574 10 mm Ø
14-575 11 mm Ø
14-576 12 mm Ø
14-577 13 mm Ø



Chevalier-Jackson Trachea Tubes
German silver

14-578 4 mm Ø
14-579 5 mm Ø
14-580 6 mm Ø
14-581 7 mm Ø
14-582 8 mm Ø
14-583 9 mm Ø
14-584 10 mm Ø
14-585 11 mm Ø
14-586 12 mm Ø
14-587 13 mm Ø

RETRACTORS

Wundhäkchen, Mikrohäkchen

Crachet, Micro crachetes

Ganchitos, Micro Ganchitos

Divariatore, Micro Divariatori



Bruenings Retractor

14-588	20 cm
14-589	30 cm
14-590	40 cm
14-591	50 cm
14-592	60 cm



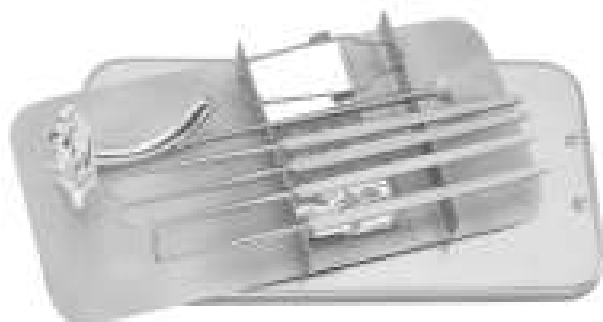
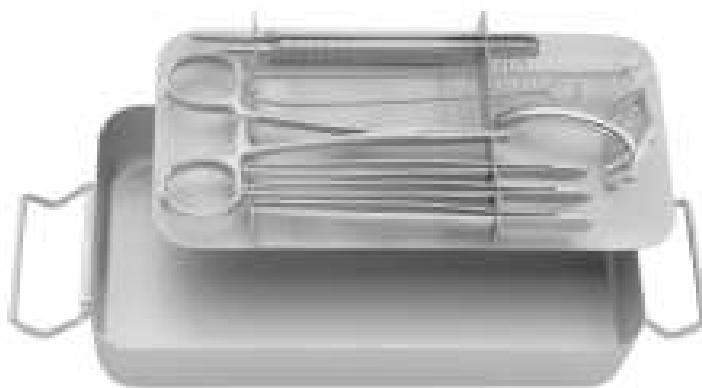
Bruenings Retractor

14-593
20 cm



Huber Retractor
14-594

TRACHEOTOMY SET



14-595

Tracheotomy Broncho-Oesophagoscopy Forceps set, In metal case,

Consisting of:

200mm x 105mm x 30mm

1 Handle, 1 Blade

1 Handle, 1 Blade

1 Dressing Forceps, 130mm

2 Tissue Forceps, 1 x 2 teeth, 130mm

2 Rochester Pisan Hemostatic forceps, 130mm

1 Grooved director, 130mm

1 Bose trachea dilator

2 Berson trachea retractors, blunt

1 Bose trachea retractor, 160mm, sharp, right

1 Bose trachea retractor, 160mm, left, right

1 Luer trachea tube, standard, 7mm, german silver

1 Luer trachea tube, standard, 8mm, german silver

1 Cleaning brush

EAR FORCEPS



Ohrzangchen | *Pinzas auriculares*
Pinces auriculaires | *Pinze auricolari*



**Hartman
Ear Forceps**
14-596



**Hartmann
Ear Forceps**
14-597
X = 8.5 cm
14-598
X = 14 cm



**Hartmann
Ear Forceps**
14-599
X = 8.5 cm
14-600
X = 14 cm
14-601
X = 16 cm



**Hartmann
Ear Forceps**
14-602 2 mm Ø
X = 8.5 cm
14-603 2.5 mm Ø
X = 8.5 cm
14-604 3 mm Ø
X = 8.5 cm



**Hartmann
Ear Forceps**
14-606



**Hartmann-Wullstein
Ear Forceps**
14-606
X = 8.5 cm



**Hartmann-Wullstein
Ear Forceps**
14-607
1 mm Ø
X = 8.5 cm



**Hartmann-Weingartner
Ear Forceps**
14-608
X = 8.5 cm



**Duckbill
Ear Forceps**
14-609



**Weingartner
Ear Forceps**
14-610



**Struempel
Ear Forceps**
14-611



**Hartmann-hoffmann
Ear Forceps**
14-612



**Hartmann-Noyes
Ear Forceps**
14-613
X = 9 cm



**Struempel
Ear Forceps**
14-614 0°
X = 8.5 cm



**Struempel
Ear Forceps**
14-615 45°
X = 8.5 cm







**Struempel
Ear Forceps**
14-616 90°
X = 8.5 cm

strumente für laryngo broncho Oesophagoskopie
strumens pour laryngo-bronco-oesophagoscope

micro instrumental para laringo bronco esofagoscopia
Micro strumenti per laringo bronco esofagoscopia



Micro Alligator Scissors

					
14-617 Straight	14-618 Straight, Horizontal	14-619 Angled up	14-620 Angled up, Horizontal	14-621 Curved right	14-622 Curved left

Alligator Forceps

				
14-623 Straight, Serrated	14-624 Straight, Horizontal	14-625 Angled up, Horizontal	14-626 Curved right	14-627 Curved left

Micro Alligator Cup shaped forceps
○ 2.5 mm

				
14-628 Straight	14-629 Angled up	14-630 Angled up, Horizontal	14-631 Curved right	14-632 Curved left

Micro Alligator Cup shaped forceps
○ 3 X 5 mm


14-633 Oval

BRONCHO OESOPHAGOSCOPY FORCEPS



14-634
X = 30 cm
14-635
X = 40 cm
14-636
X = 50 cm
14-637
X = 60 cm

14-638
X = 30 cm
14-639
X = 40 cm
14-640
X = 50 cm
14-641
X = 60 cm

14-642
X = 30 cm
14-643
X = 40 cm
14-644
X = 50 cm
14-645
X = 60 cm

14-646
X = 30 cm
14-647
X = 40 cm
14-648
X = 50 cm
14-649
X = 60 cm

**Chevalier-Jackson
Broncho
Oesophagoscope
Forceps**



14-650
X = 30 cm
14-651
X = 40 cm
14-652
X = 50 cm
14-653
X = 60 cm



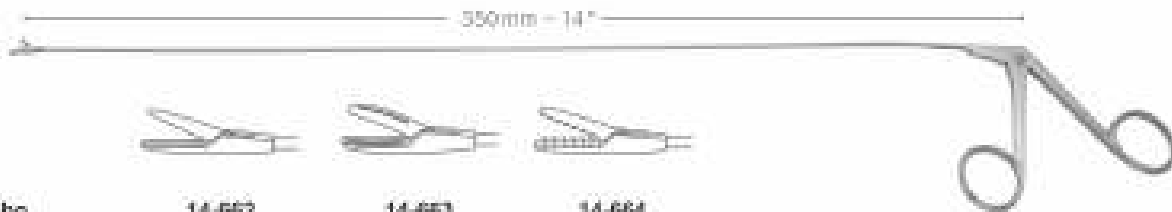
14-654
X = 30 cm
14-655
X = 40 cm
14-656
X = 50 cm
14-657
X = 60 cm



14-658
X = 30 cm
14-659
X = 40 cm
14-660
X = 50 cm
14-661
X = 60 cm

Mikro Instrumente für Laryngo broncho Oesophagoskopie
Micromstrumenti per laringo bronco-oesofagoscopie

micro instrumental para laringo bronco esofagos
Micromstrumenti per laringo bronco esofagoscopi



Grasping Broncho Oesophagoscopy Forceps



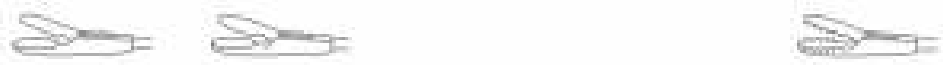
- 14-662** Straight, Serrated
- 14-663** Straight, Fenestrated
- 14-664** Straight

Cup shaped Broncho Oesophagoscopy Forceps
 Ø 3 mm



- 14-665** Straight
- 14-666** Angled up
- 14-667** Angled up, Horizontal
- 14-668** Curved right
- 14-669** Curved left

Cup shaped Broncho Oesophagoscopy Forceps



- 14-670** Straight
- 14-671** Angled up
- Universal Broncho Oesophagoscopy Forceps**
- 14-672** Curved left



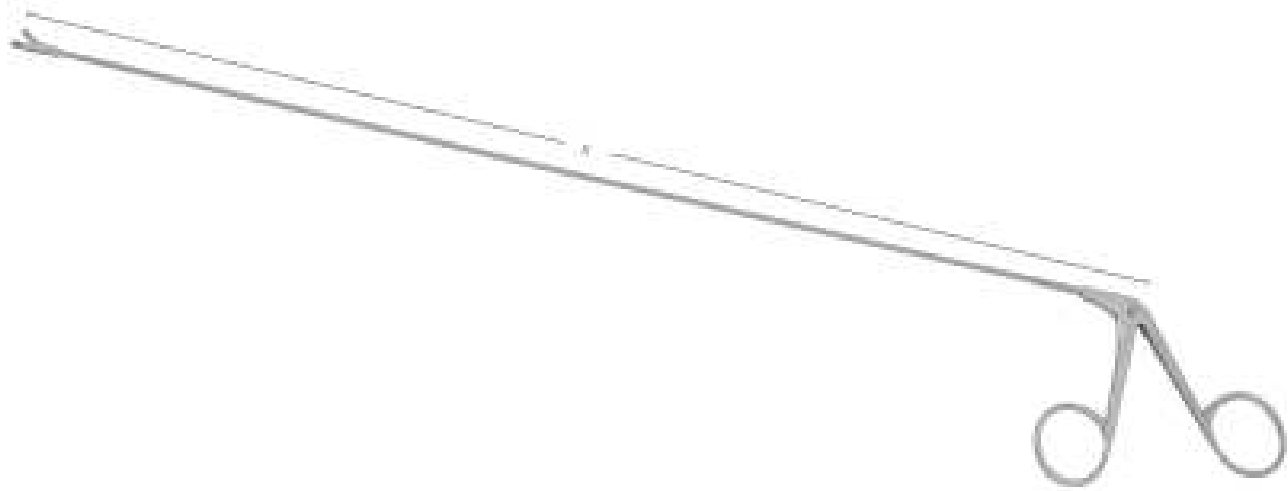
- 14-673** 25.4cm
- 14-674** 35.6cm

Yeoman Biopsy Forceps
 with Rotating Shafts, straight
 4 X 8 mm bits, with basket



Punch Broncho Oesophagoscopy Forceps

- 14-675** X = 40 cm
- 14-676** X = 50 cm
- 14-677** X = 60 cm
- 14-678** X = 40 cm
- 14-679** X = 50 cm
- 14-680** X = 60 cm
- 14-681** X = 40 cm
- 14-682** X = 50 cm
- 14-683** X = 60 cm
- 14-684** X = 40 cm
- 14-685** X = 50 cm
- 14-686** X = 60 cm



**Cup shaped Broncho
Oesophagocopy Forceps**

14-687
X = 40 cm
4 mm
14-688
X = 50 cm
4 mm
14-689
X = 60 cm
4 mm
Straight

14-690
X = 40 cm
4 mm
14-691
X = 50 cm
4 mm
14-692
X = 60 cm
4 mm
Angled up

14-693
X = 40 cm
4 mm
14-694
X = 50 cm
4 mm
14-695
X = 60 cm
4 mm
Angled up,
horizontal

14-696
X = 40 cm
4 mm
14-697
X = 50 cm
4 mm
14-698
X = 60 cm
4 mm
Curved right



**Cup shaped Broncho
Oesophagocopy Forceps**

14-699
X = 40 cm
4 mm
14-700
X = 50 cm
4 mm
14-701
X = 60 cm
4 mm
Curved left

14-702
X = 40 cm
3 mm X 4 mm
14-703
X = 50 cm
3 mm X 4 mm
14-704
X = 60 cm
3 mm X 4 mm
Straight

14-705
X = 40 cm
4 mm X 5 mm
14-706
X = 50 cm
4 mm X 5 mm
14-707
X = 60 cm
4 mm X 5 mm
Straight

14-708
X = 40 cm
4 mm X 8 mm
14-709
X = 50 cm
4 mm X 8 mm
14-710
X = 60 cm
4 mm X 8 mm
Straight



14-711
X = 40 cm
14-712
X = 50 cm
14-713
X = 60 cm
Straight

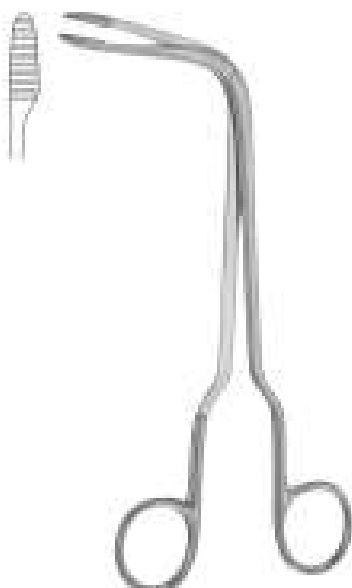
LARYNGEAL POLYPUD FORCEPS

Kehikropfpolypenzangen

Pinças para polipas laringeas

Pinces a polypes laryngiens

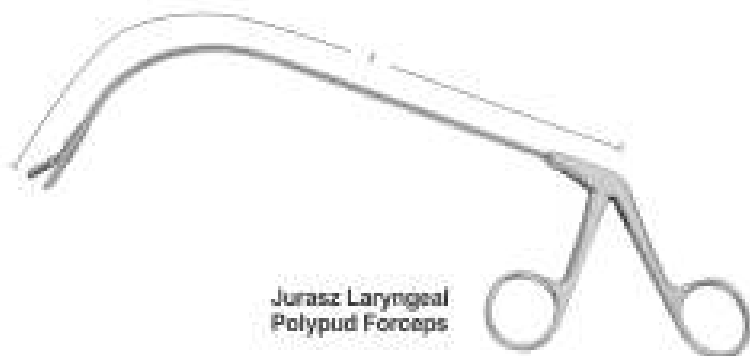
Pinze per polipi laringel



Fraenkel Laryngeal Polypud Forceps
14-714 - 18 cm



Fraenkel Laryngeal Polypud Forceps
14-715
X = 17 cm
Both jaws articulated



Jurasz Laryngeal Polypud Forceps



Jurasz Laryngeal Polypud Forceps



14-716
23 cm
Right



14-717
23 cm
Left



14-720
23 cm
Right



14-721
23 cm
Left



14-718
23 cm
Downwards



14-719
23 cm
Upwards



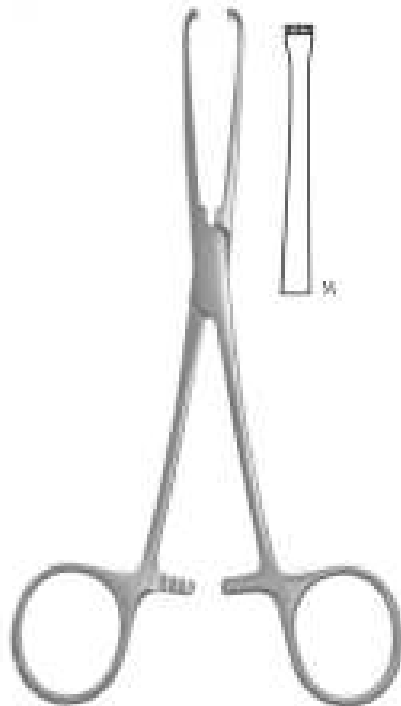
14-722
23 cm
Downwards



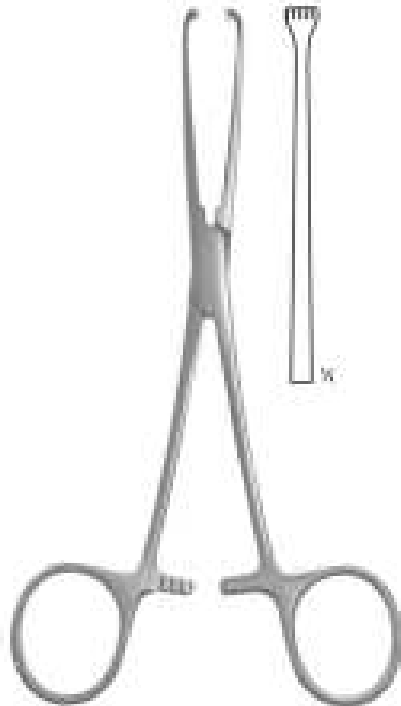
14-723
23 cm
Upwards

INTESTINAL & TISSUE GRASPING FORCEPS

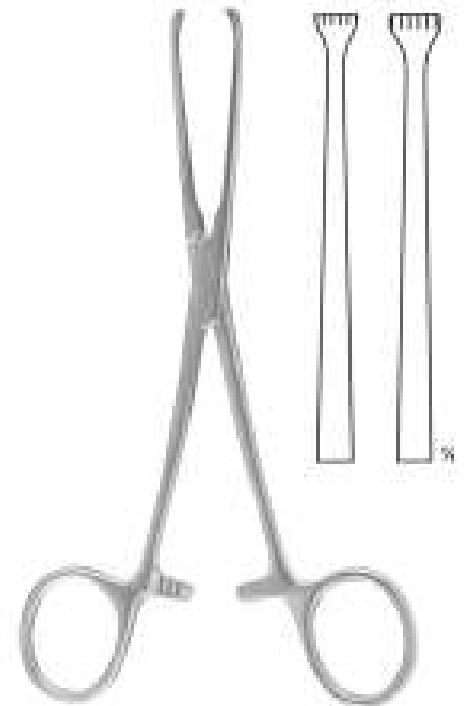
Darm- und Gefäßfessungen | *Pinces Pour Saisir Intestins et Tissus*
 Pinzas Para Intestinos y Tejidos | *Pinze Per Afferrare Intestino e Tessuti*



Allis Tissue Forceps
 15-001 15 cm
 3 x 4 teeth



Allis Tissue Forceps
 15-002 15.5 cm
 4 x 5 teeth



Allis Tissue Forceps
 15-003 16 cm
 15-004 19 cm
 15-005 22 cm
 15-006 25.5 cm
 5 x 6 teeth



Baby Allis Tissue Forceps
 15-007 12 cm 4 X 5 teeth
 15-008 14 cm 4 X 5 teeth
 delicate jaws 4 mm wide



Judd-Allis Tissue Forceps
 15-009 19.5 cm
 3 x 4 teeth



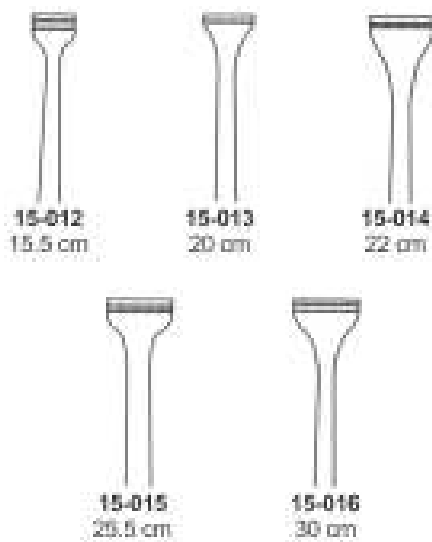
Williams Grasp Forceps
 15-010 16 cm



Boys-Allis Tissue Forceps
 15-011 15.5 cm
 5 x 6 teeth, sharp



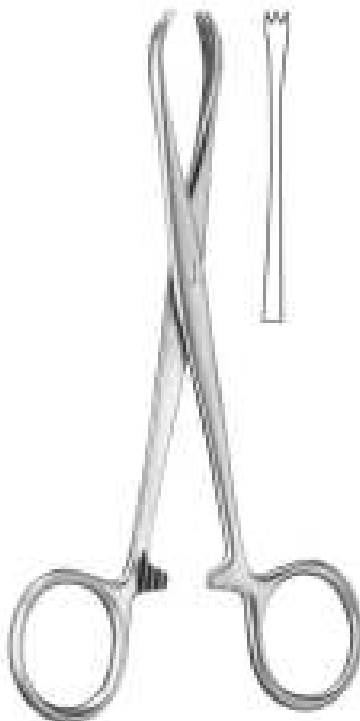
Allis Tissue Grasping Forceps



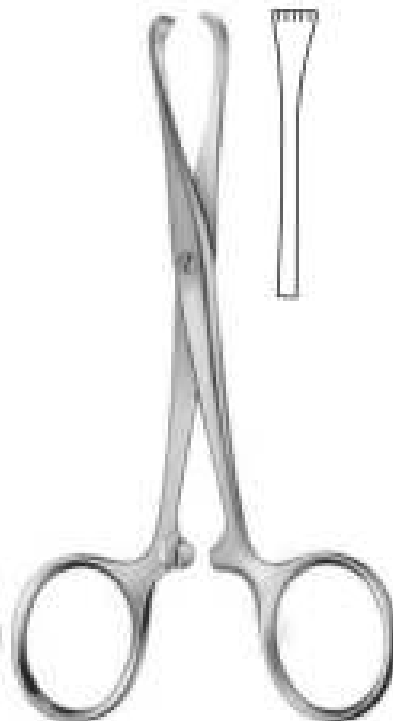
Allis-Adair
 15-017
 Intestinal and Tissue Grasping Forceps
 16 cm



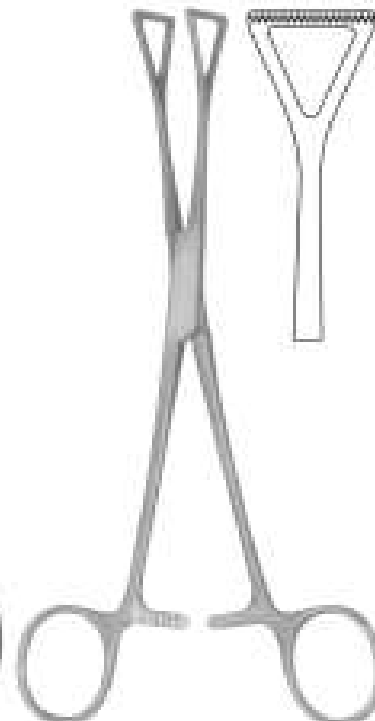
Thoms-Allis
 15-018
 Intestinal and Tissue Grasping Forceps
 20.5 cm



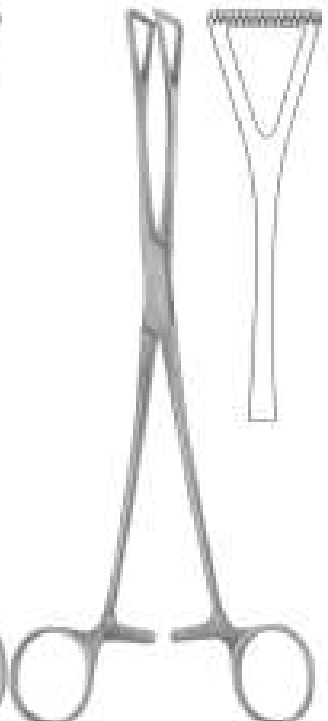
Chaput Tissue Forceps
 15-019 12.5 cm
 2 x 3 teeth, sharp



Tuffier Tissue Forceps
 15-020 12.5 cm
 5 x 6 teeth, sharp



Duval-Collin Grasp Forceps
 15-021 18 cm
 15-022 20 cm



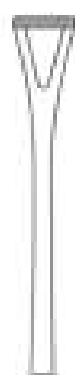
Duval Grasp Forceps
 15-023 23 cm

INTESTINAL & TISSUE GRASPING FORCEPS

Darm- und Gefäßzangen | Pincas Pour Saisir Intestins et Tissus
 Pinzas Para Intestinos y Tejidos | Pinze Per Afferrare Intestino e Tessuti



Babcock Seizing Forceps



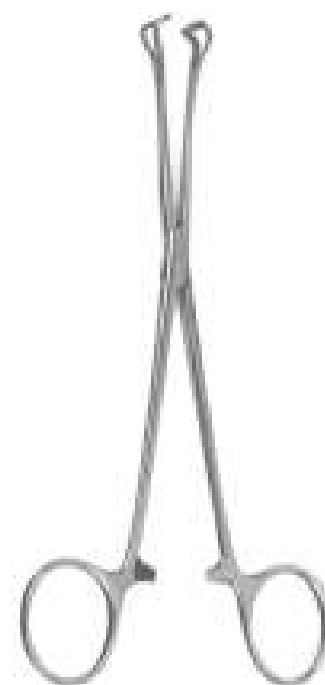
15-024 16 cm
 15-025 18 cm
 15-026 20 cm
 15-027 22 cm



Babcock Tissue Grasping Forceps



15-028 16 cm
 15-029 23.5 cm



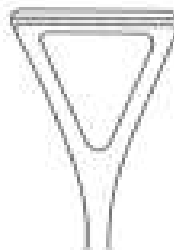
Babcock Tissue Grasping Forceps
 15-030 18 cm
 15-031 24 cm



Collin Grasp Forceps
 15-032 14 cm



Collin Tissue Grasping Forceps
 15-033 19.5 cm



Collin Tissue Grasping Forceps
 15-034 23 cm



INTESTINAL & TISSUE GRASPING FORCEPS

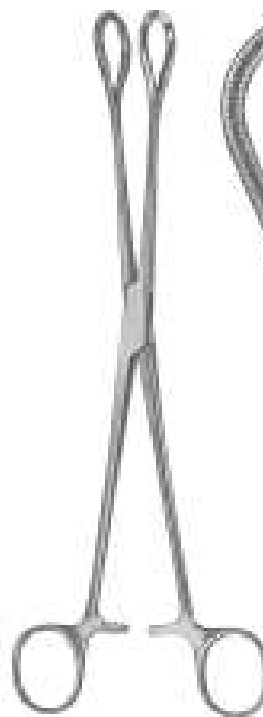
Darm- und Gewebefassungen | *Pinces Pour Saisir Intestins et Tissus*
 Pinzas Para Intestinos y Tejidos | *Pinze Per Afferrare Intestino e Tessuti*



Little Wood Tissue Grasping Forceps
 15-047 19 cm
 Box Joint



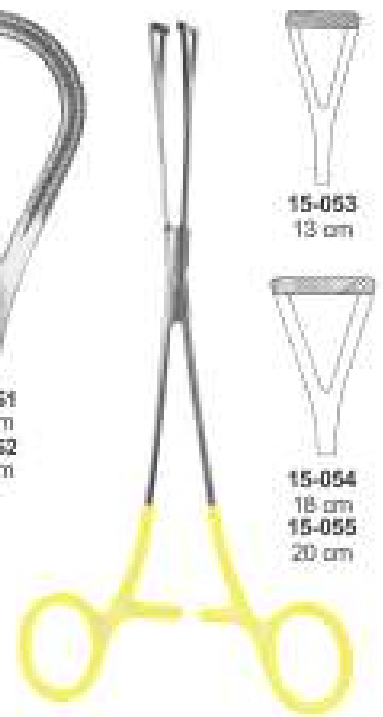
Lane Tissue Grasping Forceps
 15-048 12.5 cm
 15-049 15 cm
 15-050 19 cm



Duval Intestinal and Tissue Grasping Clamp Forceps



15-051 25 cm
 15-052 27 cm



Duval Intestinal & Tissue Grasping Clamp Forceps T.C

15-053 13 cm



15-054 18 cm
 15-055 20 cm

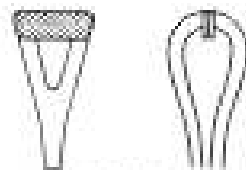


Babcock Intestinal & Tissue Grasping Clamp Forceps T.C

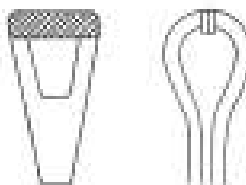


15-056 16.5 cm

15-057 20.3 cm



15-058 17.5 cm



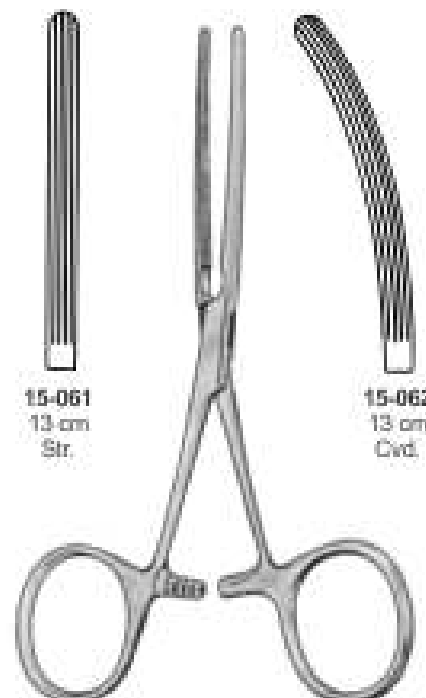
15-059 19.5 cm



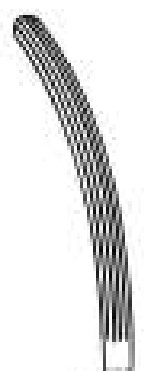
Stone-Watt Closing Forceps
 15-060 15cm



15-061 13 cm Str.



Baby-Kocher Intestinal Forceps Clamps

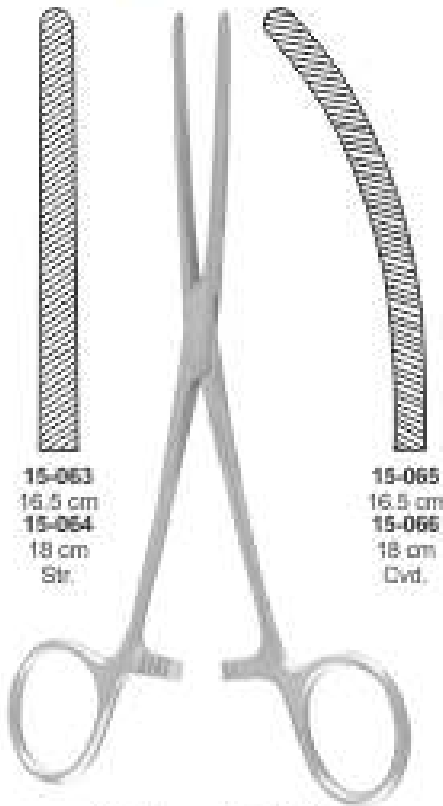


15-062 13 cm Cvd.

INTESTINAL CLAMPS

Darmklemmen | Pincas Intestinales

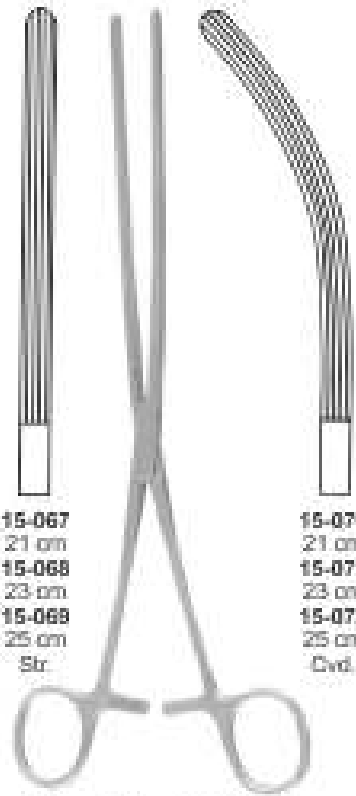
Pinzas Intestinales | Pinze Intestinali



15-063
16.5 cm
15-064
18 cm
Str.

15-065
16.5 cm
15-066
18 cm
Cvd.

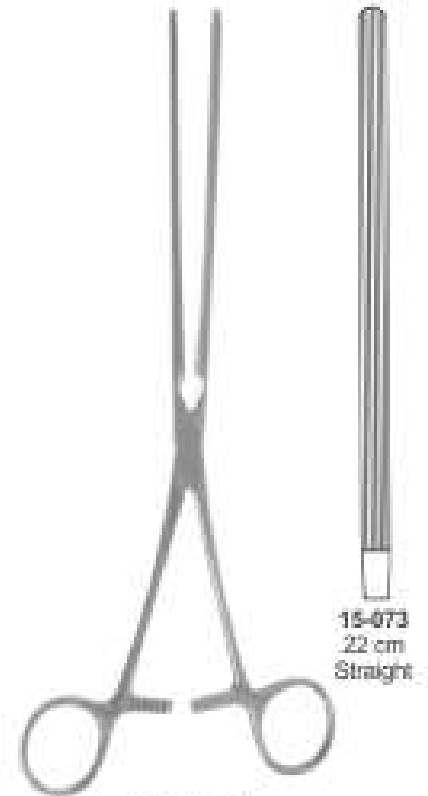
**Baby-Doyen Intestinal
Forceps Clamps**



15-067
21 cm
15-068
23 cm
15-069
25 cm
Str.

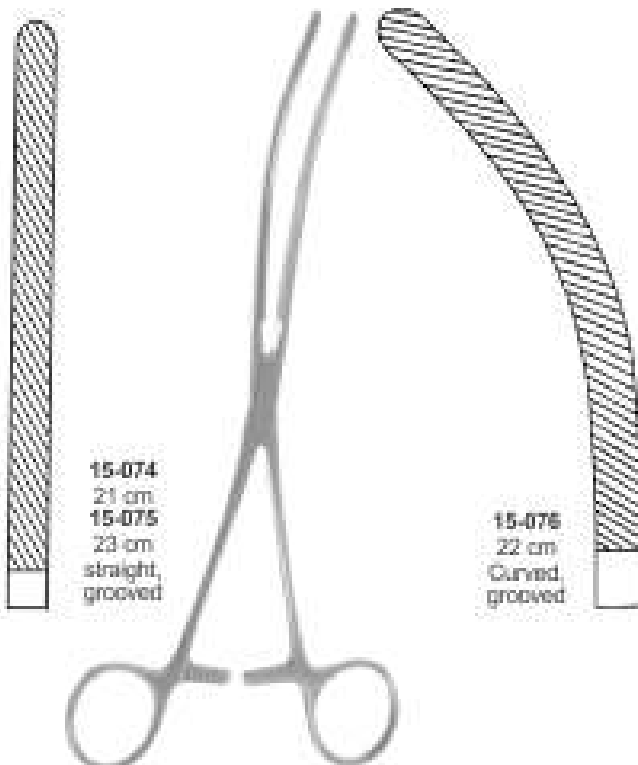
15-070
21 cm
15-071
23 cm
15-072
25 cm
Cvd.

**Mayo-Robson Intestinal
Forceps Clamps**



15-073
22 cm
Straight

**Kocher Intestinal Forceps
Clamps**



15-074
21 cm
15-075
23 cm
straight,
grooved

15-076
22 cm
Curved,
grooved

**Doyen Intestinal Forceps
Clamps**



15-077 13 cm
15-078 15 cm
15-079 17 cm
15-080 21 cm
15-081 23 cm

**Doyen-Baby
Intestinal Clamp**



Mayo-Vessel Clamp
15-082 25.5cm
Curved, 3.8cm
tip

INTESTINAL CLAMPS

Darmklemmen | Pinças Intestinais
Pinzas Intestinales | Pinze Intestinali



15-083
25 cm
Str.



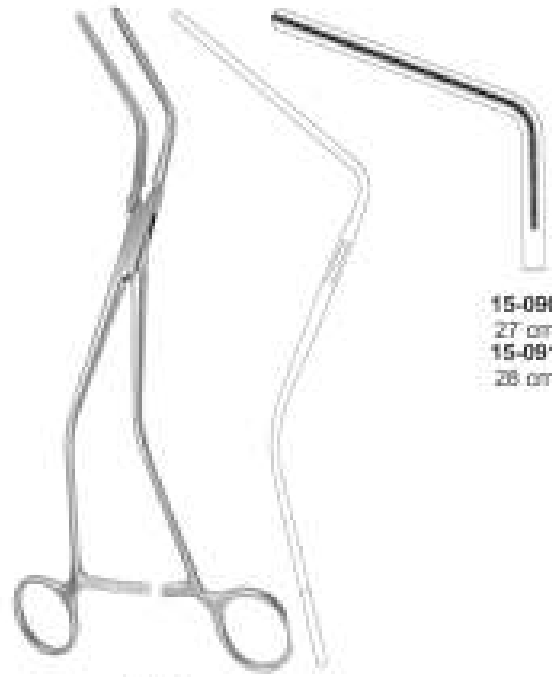
15-084
25 cm
Cvd.

Mayo-Robson
Intestinal Clamp



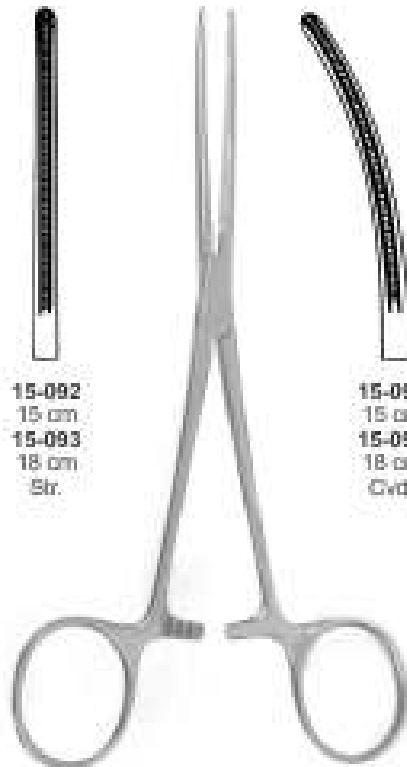
15-085
13 cm
15-086
15 cm
15-087
17 cm
15-088
21 cm
15-089
23 cm

Doyen-Baby
Intestinal Clamp



15-090
27 cm
15-091
28 cm

Hayes
Sigmoid Anastomosis Forceps

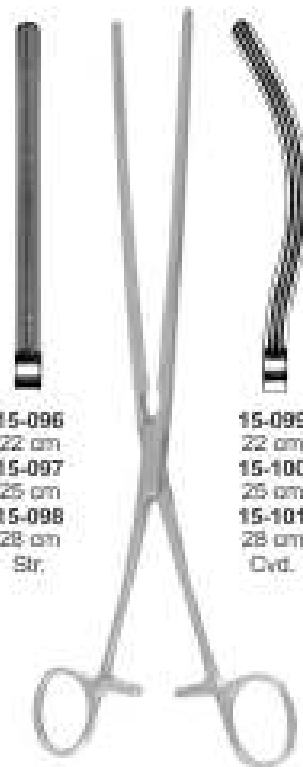


15-092
15 cm
15-093
18 cm
Str.



15-094
15 cm
15-095
18 cm
Cvd.

Bainbridge Intestinal
Forceps Clamps



15-096
22 cm
15-097
25 cm
15-098
28 cm
Str.

15-099
22 cm
15-100
25 cm
15-101
28 cm
Cvd.

Kocher Intestinal Forceps
Clamps



15-102
13 cm
15-103
16 cm
15-104
18 cm
15-105
21 cm
15-106
23 cm
Str.

Doyen Intestinal
Forceps Clamps

Isstranje, Darm-anastomosenklemmen

Pinces Pour Saisir Polypes, Pinces-clamps Pour Anastomose Intestinale

rs: Coger Pólipos, Clamps Para Anastomosis Intestinales

Pinze Per Afferrare Polipi, Pinze Per Anastomosi Intestinali



Doyen Intestinal Forceps Clamps



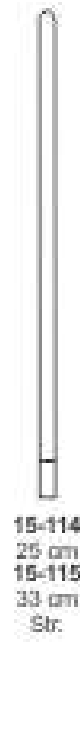
15-107
13 cm
15-108
16 cm
15-109
18 cm
15-110
21 cm
15-111
23 cm
Cvd.



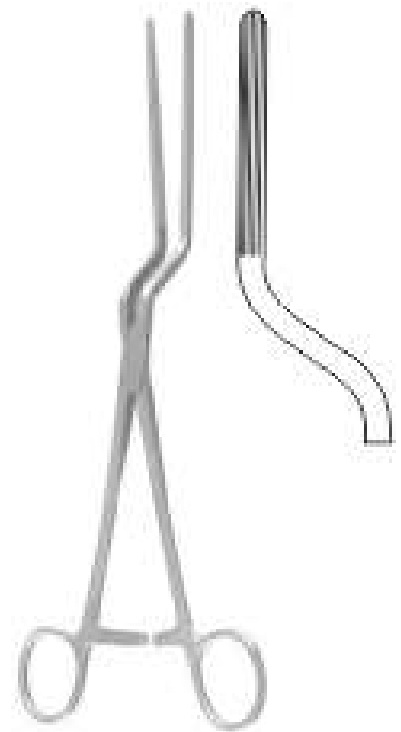
Scudder Intestinal Forceps Clamps



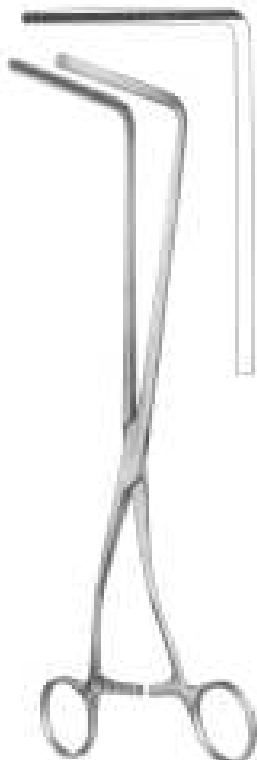
15-112
25 cm
15-113
33 cm
Cvd.



15-114
25 cm
15-115
33 cm
Str.



Brunner Intestinal Polyous Grasping Forceps
15-116 24 cm



Resano Intestinal Polyous Grasping Forceps
15-117 30 cm



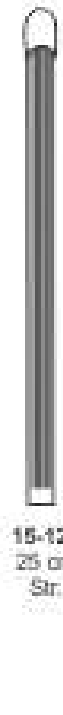
Fehland Intestinal Polyous Grasping Forceps
15-118 24 cm



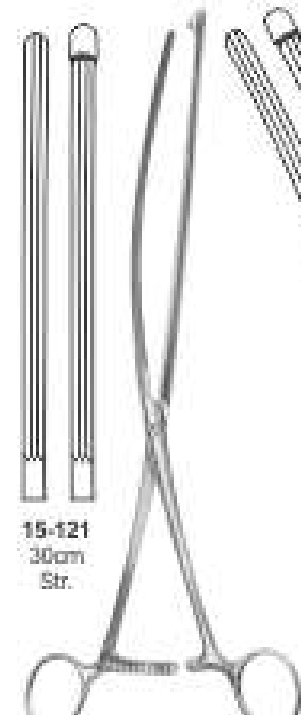
Nussbaum Intestinal Forceps Clamps



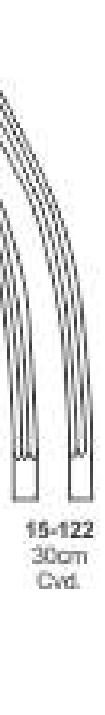
15-119
25 cm
Cvd.



15-120
25 cm
Str.



Nussbaum Stomach Intestinal Twin Clamp Forceps



15-121
30cm
Str.

15-122
30cm
Cvd.

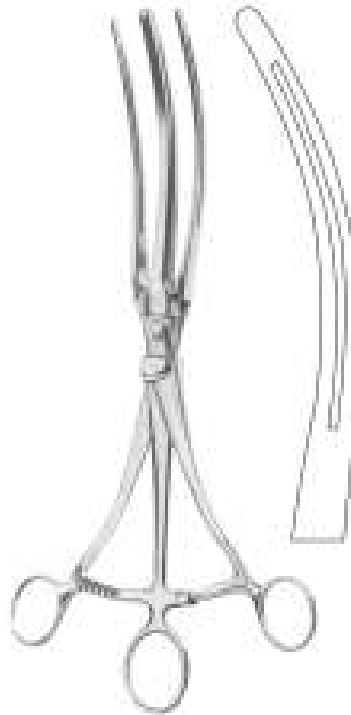
INTESTINAL CLAMPS

Darmklemmen	Pincas Intestinales
Pincas Intestinales	Pincas Intestinali

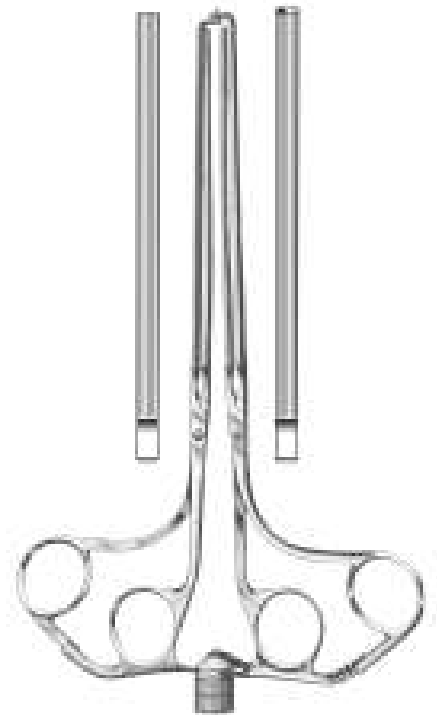
Intestinal & Stomach Twin Clamp Forceps



**Haberer Stomach Intestinal
Twin Clamp Forceps**
15-123 36cm



**Roosevelt Stomach Intestinal
Twin Clamp Forceps**
15-124 34cm



**Abadie Stomach Intestinal
Twin Clamp Forceps**
15-125 22cm
15-126 27cm



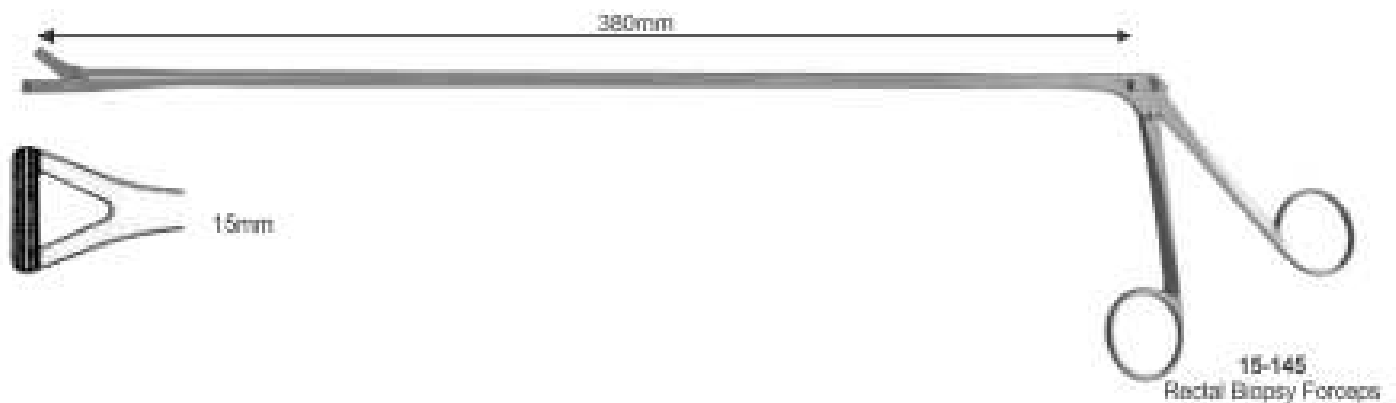
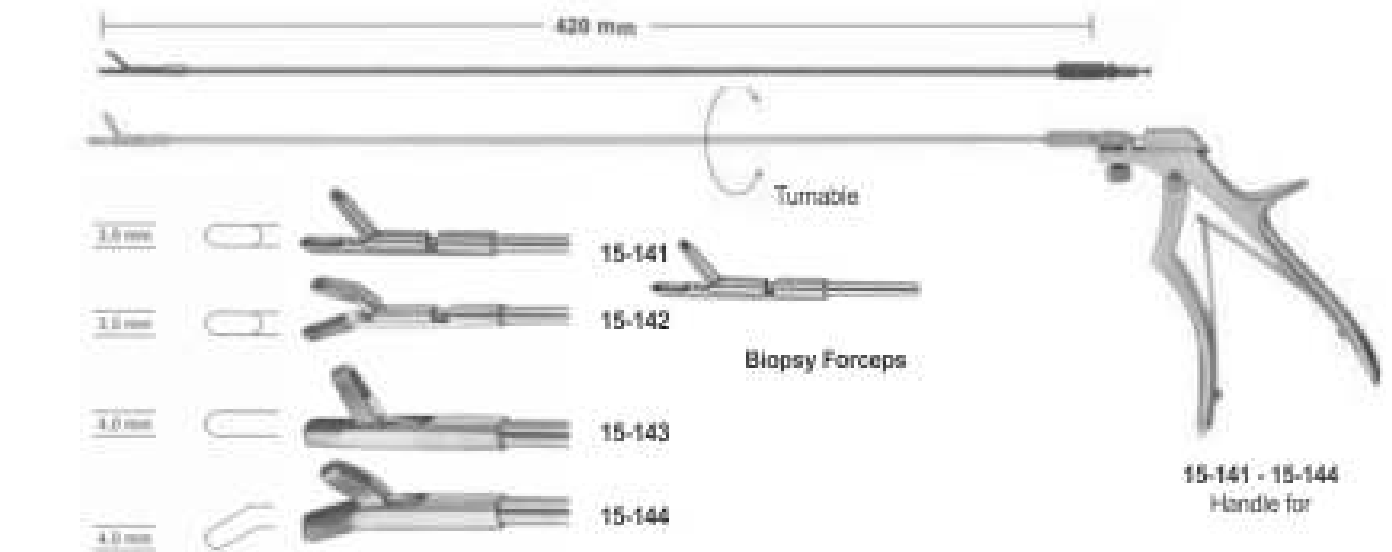
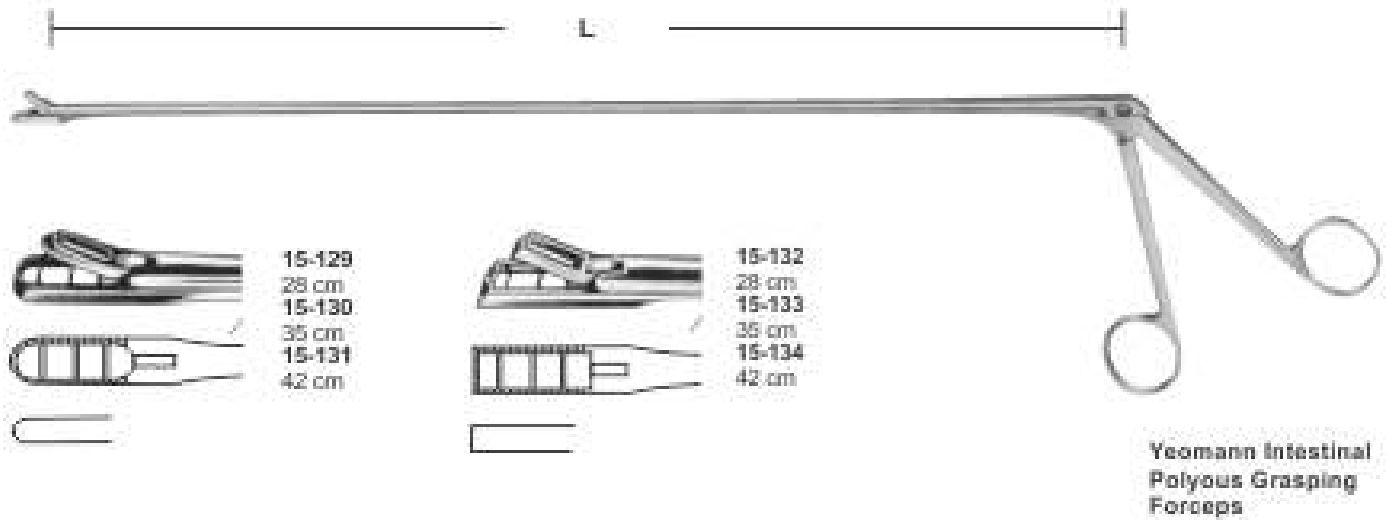
**Lane Stomach Intestinal
Clamp Forceps**
15-127
30 cm Str.



**Lane Stomach Intestinal
Clamp Forceps**
15-128
30 cm Cvd.

1532-36, Darm-anastomosenklemmen
a Coger Polipos, Clamps Para Anastomosis Intestinales

Pince Pour Saisir Polypes, Pince-clamps Pour Anastomose Intestinale
Pince Per Afferrare Polipi, Pince Per Anastomosi Intestinali



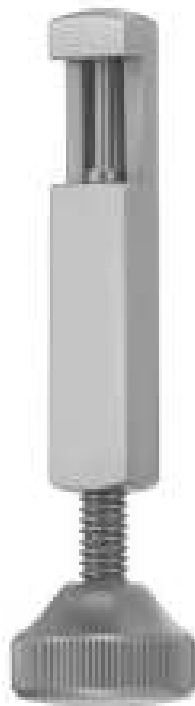
POLYOUS GRASPING FORCEPS, ANASTOMOSIS

Polyperfassenge, Darm-anastomosenklemmen

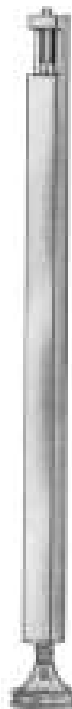
Pince Pour Saisir Polypes, Pincas-clamps Pour Anastomose à

Pinza Para Coger Polipos, Clamps Para Anastomosis Intestinales

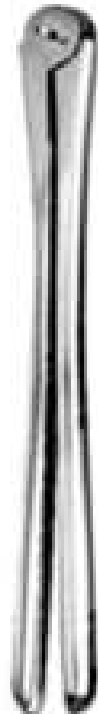
Pinze Per Afferrare Polipi, Pinze Per Anastomosi Intestinali



**De Martel-Wolfson
Clamp Holder**
15-146 8.5 cm



**De Martel-Wolfson
Clamp Holder**
15-147 23 cm



**Stone-Watt
Intestinal Anastomosis Clamp**
15-148 8.5cm
15-149 10cm



**De Martel-Wolfson
15-150 set of 3
anastomosis clamps**



**Jaw length:
15-151
5 cm**



**Jaw length:
15-152
7 cm**



**Jaw length:
15-153
10 cm**



**De Martel-Wolfson
Closing Forceps
15-154
26 cm**

INTESTINAL CLAMPS

Darmklemmen

Pincas Intestinales

Pinzas Intestinales

Pinze Intestinali



Payr-Baby Crushing Intestinal Clamp

15-155

15 cm
without pin

15-156

15 cm
with pin

Payr Crushing Intestinal Clamp

15-157

21 cm
without pin

15-158

21 cm
with pin

Payr Crushing Intestinal Clamp

15-159

29 cm
without pin

15-160

29 cm
with pin

Payr Crushing Intestinal Clamp

15-161

35 cm
without pin

15-162

35 cm
with pin

INTESTINAL RECTAL SPECULA

Mastdarmapekula | Spéculum Rectaux
Especulas Rectales | Speculi Rectali



90 x 15 mm

Mathieu Rectal Speculum
15-163 19 cm
90 x 15 mm



Sims Rectal Speculum
15-164 15 cm



Sims Rectal Speculum
15-165 15 cm



Ives-Fansler Rectal Speculum
15-166 14.5 cm
22 mm Ø



Pratt Rectal Speculum
15-167 21.5 cm
85 x 25 mm blade



Czerny Rectal Speculum
15-168
22 cm



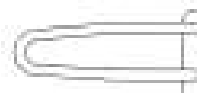
Barr Rectal Speculum
15-169 80mm
Blade size



Smith-Blue Intestinal Rectal Speculum
15-172 15 cm
75 x 23 mm



15-170
for extra blades



15-173 22 cm
20 x 65 mm
15-174 22 cm
25 x 85 mm
15-175 22 cm
25 x 120 mm
15-176 22 cm
23 x 145 mm



Alan-Parks
15-171
Alan-Parks
14 cm



Schulze-Bergmann Intestinal Rectal Speculum



**Hirschmann Intestinal
Rectal Speculum**
15-177
23 mm Ø
proctoscope
working length: 145 mm



15-178
22 ø x 50 mm
15-179
22 ø x 100 mm
15-180
22 ø x 140 mm
15-181
22 ø x 200 mm

**Kelly Intestinal
Rectal Speculum**



**Barr-Shifford Intestinal
Rectal Speculum**
15-182



**Vernon-David Intestinal
Rectal Speculum**
with thumb grip handle
15-183 short handle
15-184 long (standard) handle



**Bensaude Intestinal
Rectal Speculum**
15-185 19 ø x 70 mm
15-186 22 ø x 70 mm



Brinkerhoff Intestinal Rectal Speculum
15-187 small 69 x 25mm tapers to 13mm
15-188 medium 101 x 25mm tapers to 15mm
15-189 large 120 x 31mm tapers to 19mm

INTESTINAL RECTAL SPECULA

Mastdarmapekula | Spéculum Rectaux
Especulas Rectales | Speculi Rectali



Fensler Operating Intestinal Rectal Speculum

with slotted / extra long handle standard

15-190 25 mm x 65 mm
15-191 29 mm x 65 mm
15-192 38 mm x 70 mm

with slotted tube / short handle
15-193 29 mm x 60 mm
15-194 operating speculum



Chelsea-Eaton Intestinal Rectal Speculum

solid handle

15-195 small
15-196 large
with light connection available



Hirschman Anoscope Intestinal Rectal Speculum

15-197 small
57 x 14mm inside diameter
15-198 medium
52 x 17mm inside diameter
15-199 large
89 x 22mm inside diameter



Buis Hirschman Anoscope Intestinal Rectal Speculum

15-200 small
57 x 14mm inside diameter
15-201 medium
55 x 19mm inside diameter
15-202 large
98 x 25mm inside diameter



Ives-Fensler Anoscope Intestinal Rectal Speculum

with hard rubber obturator / fenestrated handle
15-203 22 mm x 85 mm



Long Chrome Handle Intestinal Rectal Speculum
15-204 81 x 29mm



Morgen Proctoscope Intestinal Rectal Speculum

with light connection
15-205 17mm
15-206 20mm
15-207 24mm

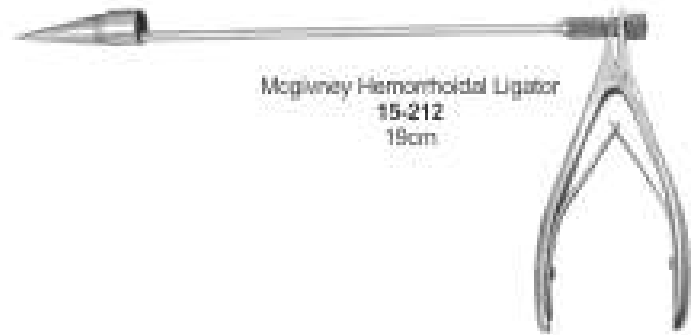


Kelly Proctoscope Intestinal Rectal Speculum

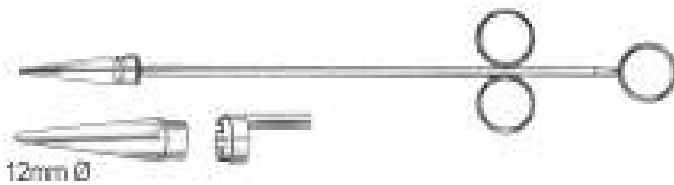
chrome plated
15-208 22mm x 50 mm
15-209 22mm x 100 mm
15-210 22mm x 145 mm



Hemorrhoidal Ligator-Suction
15-211



McGivney Hemorrhoidal Ligator
15-212
19cm



15-213
Rudd Hemorrhoidal Ligator with loading cone 12mmØ
31.5 cm Str.

15-214
Rudd Hemorrhoidal Ligator with loading cone 12mmØ
31.5 cm Cvd



15-215
Lurz Hemorrhoidal Suction Ligator 8mm Ø
15-216
Lurz Hemorrhoidal Suction Ligator 10mm Ø

15-217
Ligator rubber rings
in package of 100 pieces



15-218
McGivney Hemorrhoid Grasping Forceps
19 cm angled shank



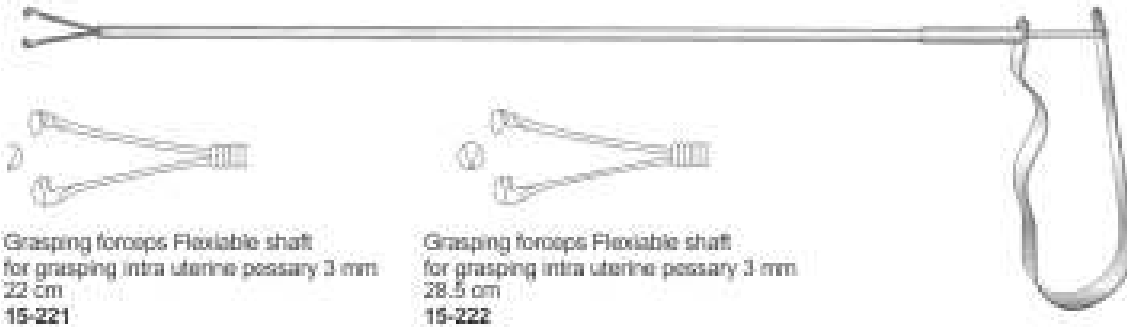
15-219
McGivney Hemorrhoidal Ligator
With Offset Handle 19 cm
Working Length



McGivney Hemorrhoidal Ligator
Complete Set
15-220

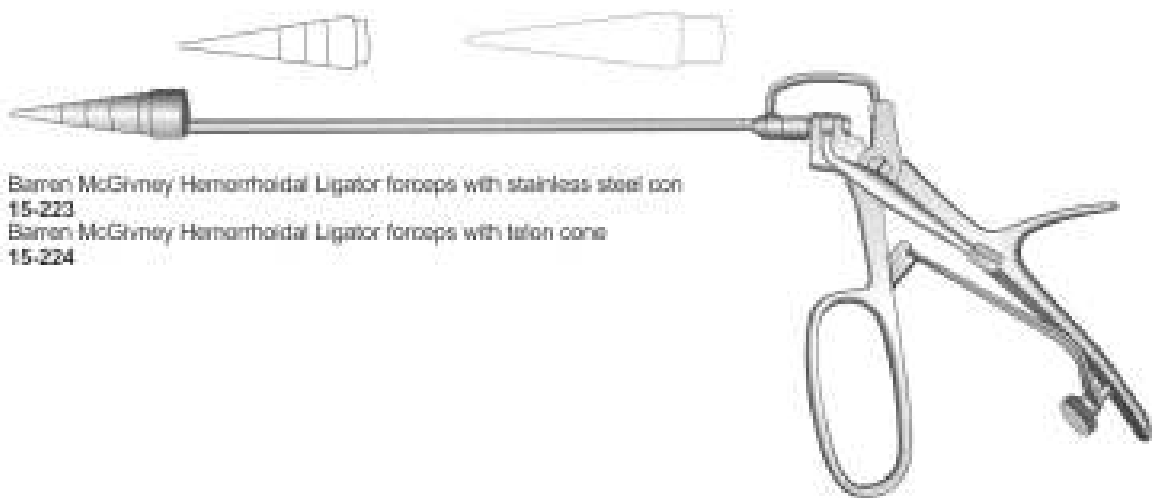
INTESTINAL RECTAL SPECULA

<i>Mastdarmspekula</i>	<i>Spéculum Rectaux</i>
<i>Especulos Rectales</i>	<i>Specoli Rettali</i>

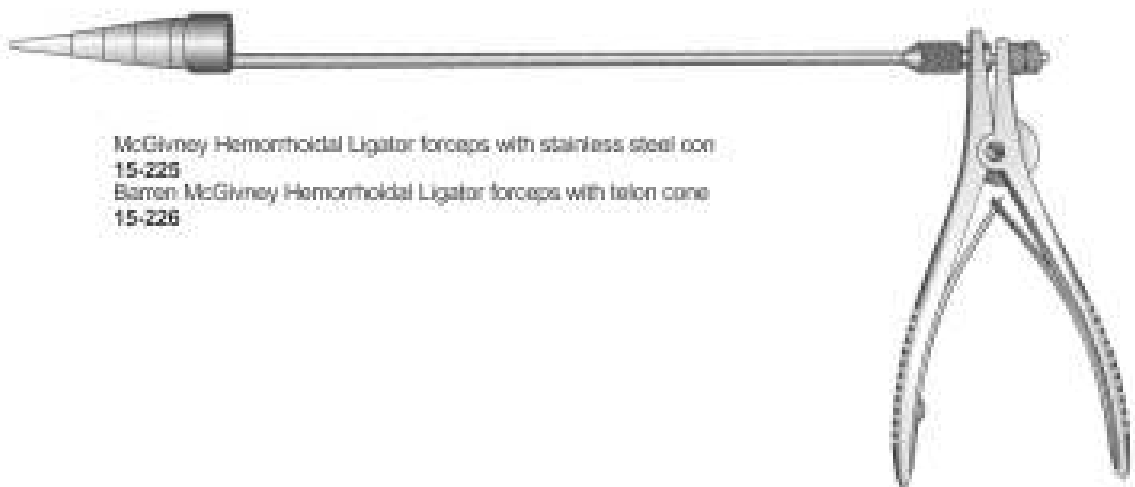


Grasping forceps Flexible shaft
for grasping intra uterine pessary 3 mm
22 cm
15-221

Grasping forceps Flexible shaft
for grasping intra uterine pessary 3 mm
28.5 cm
15-222



Bairn McGivney Hemorrhoidal Ligator forceps with stainless steel con
15-223
Bairn McGivney Hemorrhoidal Ligator forceps with telon cone
15-224



McGivney Hemorrhoidal Ligator forceps with stainless steel con
15-225
Bairn McGivney Hemorrhoidal Ligator forceps with telon cone
15-226



McGivney Hemorrhoidal Ligator forceps with stainless steel con
15-227 17.5 cm
Bairn McGivney Hemorrhoidal Ligator forceps with telon cone
15-228 17.5 cm

UROLOGY INSTRUMENTS



KIDNEY STONE FORCEPS

Nierensteinzangen

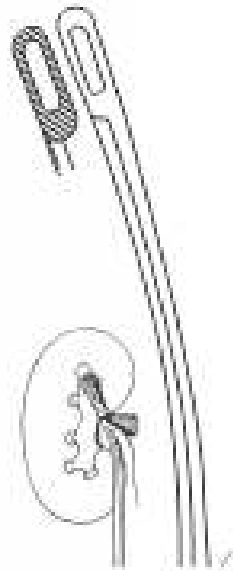
Pinces pour les calculs du bassinet

Pinzas para cálculos renales

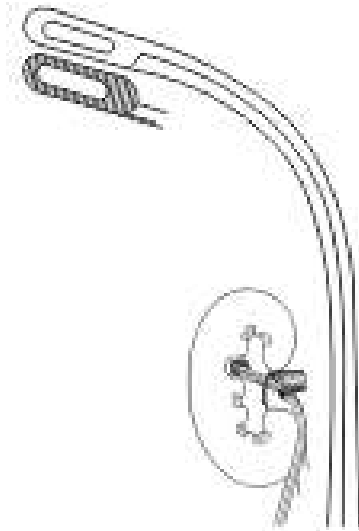
Pinze per calcoli renali



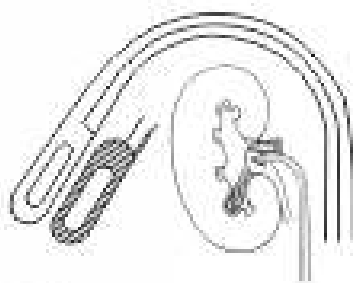
Randall Kidney Stone Clamps Forceps



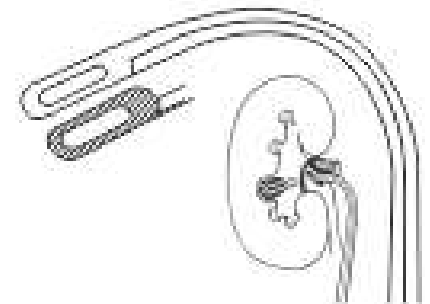
16-001
23 cm
quarter curved



16-002
23 cm
half curved



16-003
23 cm
full curved



16-004
23 cm
three-quarter curved

Nierensteinzangen

Pinces pour les calculs du bassinet

Pinças para cálculos renais

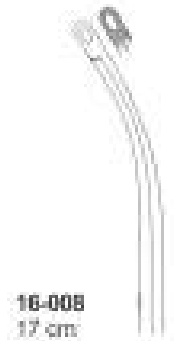
Pinze per calcoli renali



Randall
Kidney Stone Forceps



Helling
Kidney Stone Forceps



B



Elsasser
Nephrostomy Forceps



16-009
21 cm
Fig. 1



16-010
21 cm
Fig. 2

KIDNEY STONE FORCEPS

Nierensteinzangen

Pinces pour les calculs du bassin

Pinças para cálculos renais

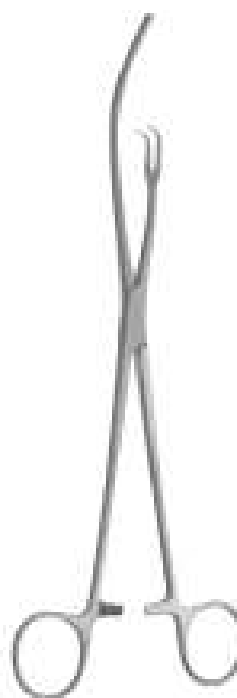
Pinze per calcoli renali



Dartigue's Uterine Elevating Forceps
16-011 27 cm



Collin Kidney Elevating Stone Clamps Forceps
16-012 28.5 cm



Hulka-Kanwick Uterine Elevating & Manipulating Forceps
16-013 27 cm



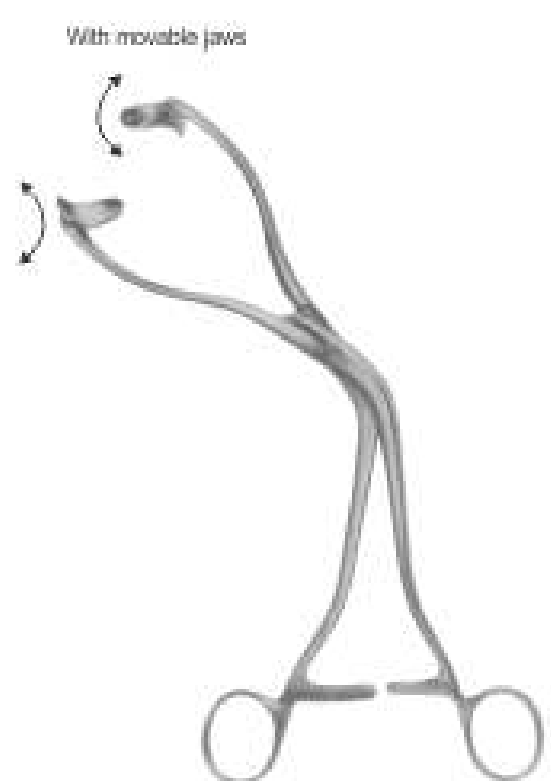
Somer Kidney Elevating Stone Clamps Forceps
16-014 23.5 cm



Strassmann Kidney Elevating Stone Clamps Forceps
16-015 26 cm



Collin Kidney Elevating Stone Clamps Forceps
16-016 26.5 cm



Collin Kidney Elevating Stone Clamps Forceps
16-017 26 cm

GALL STONE FORCEPS

Gallensteinzangen | Pincers pour calculs biliaires
Gallensteinlöffel | Curettes pour calculs biliaires



Blake Gall Stone Forceps
16-018 20 cm
Straight



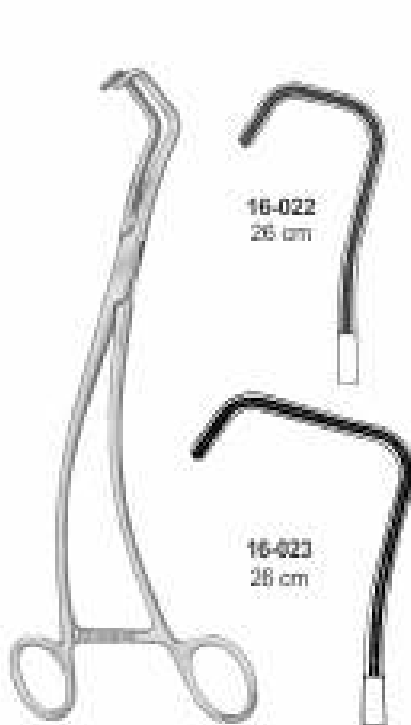
Blake Gall Stone Forceps
16-019 21 cm
Curved



Mayo-Blake Gall Stone Forceps
16-020 20 cm
Straight



Mayo-Blake Gall Stone Forceps
16-021 20 cm
Curved



Uro-Tangential Gall Stone Forceps

16-022
25 cm

16-023
26 cm



Mixer Gall Stone Forceps
16-024 22 cm



Desjardins Gall Stone Forceps
16-025 23 cm



Desjardins Gall Stone Forceps
16-026 23 cm

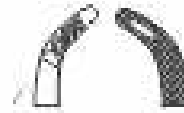
CAPSULE FORCEPS, LIGATURE CARRYING FORCEPS

Kapselzangen, Fadenführungszange | Pincès pour saisir les capsules, Pince porte-fil
Pinzas capsulares, Pinza porta ligaduras | Pinze per afferrare capsule, Pinza porta filo



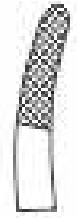
16-027
24 cm

Harris Capsule Ligature Angled Suture Forceps



16-028
29 cm

Johnson Prostatic Needle Holder



16-029
23 cm

Straffe Needle Holder



Millin Prostatectomy Forceps
16-030 24 cm



Millin Prostatectomy Forceps
16-031 23 cm



Millin Vulsellum Forceps
16-032 23 cm



Millin Ligature Carrying Forceps Angular
16-033 23 cm

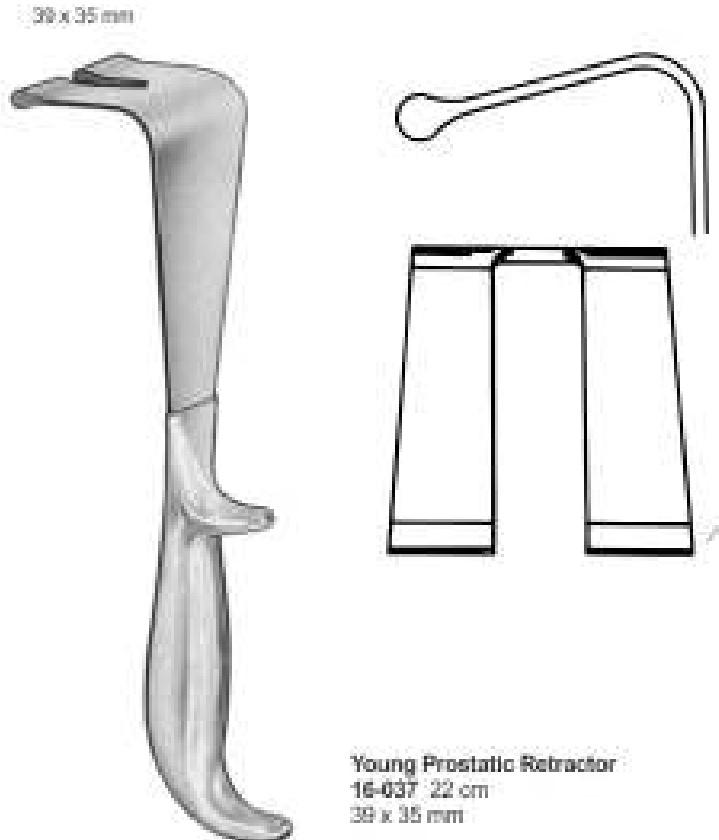
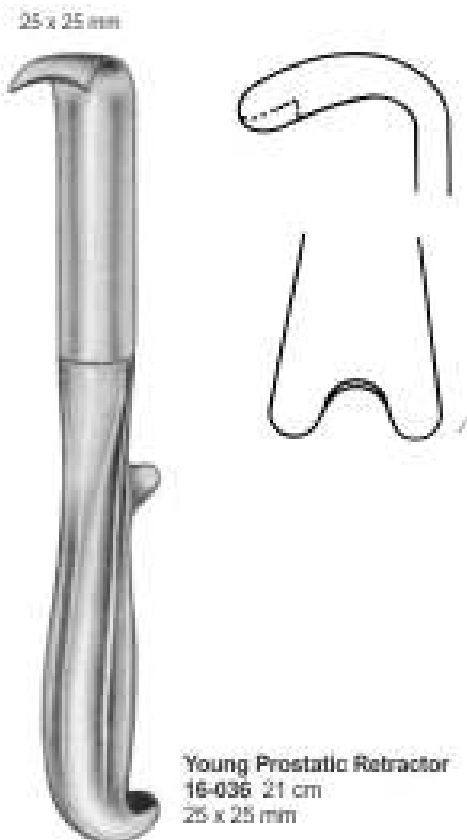
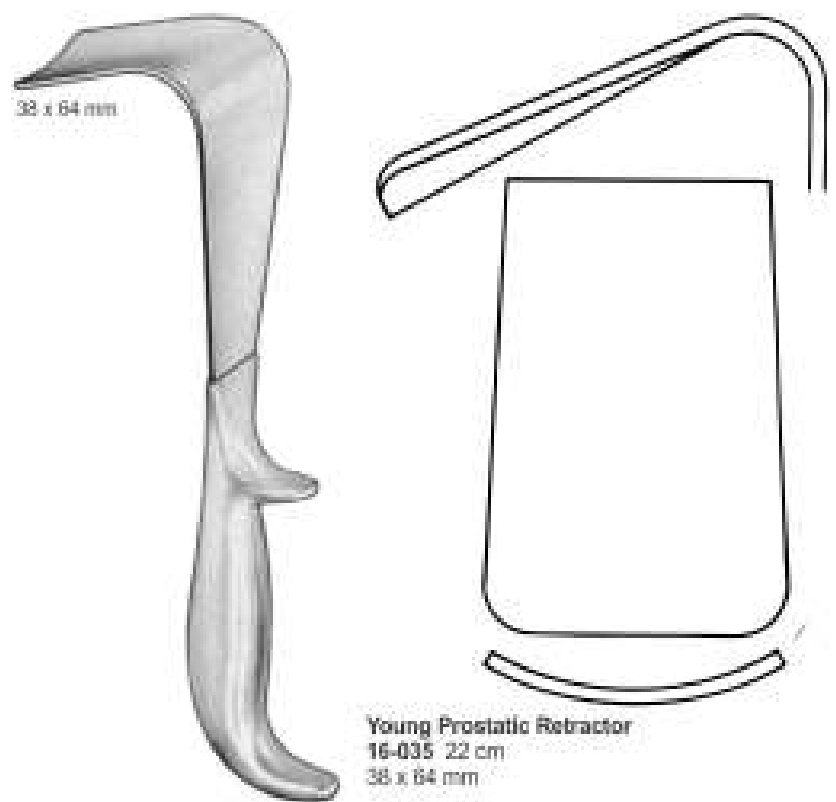
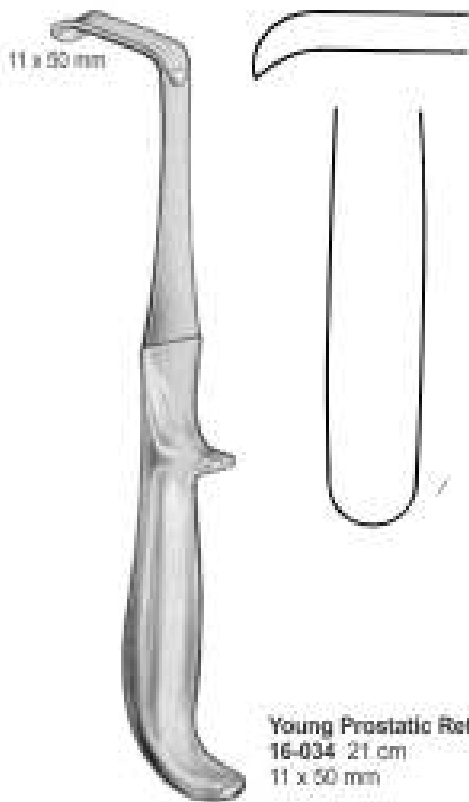
PROSTATIC RETRACTOR

Prostatahaken

Ecarteurs prostatiques

Separadores para próstata

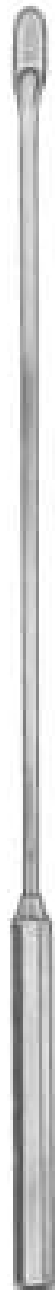
Divaricatori prostatici



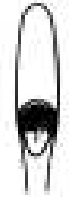
GALL DUCT DILATOR

Gallenkanaldilatatoren
Gallensteinzangen

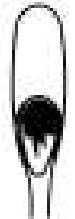
Dilatateurs pour les voies biliaires
Pincettes pour calculs biliaires



**Desjardins Probe
& Catch with flexible
shaft 28 cm**



**16-038
17 F.G.**



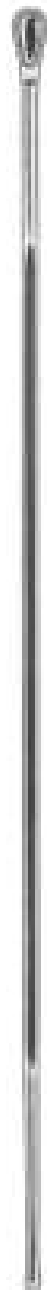
**16-039
21 F.G.**



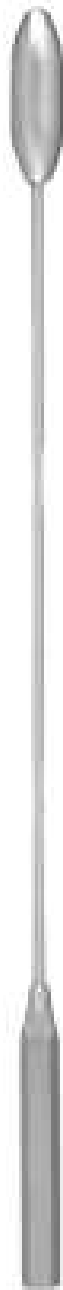
**16-040
24 F.G.**



**16-041
27 F.G.**



**Moynihan
16-042
34 cm**



**Bakes Common Bile
Duct Dilators, Malleable
16-043
Set of 13
32 cm**



**Fig. 1
16-044**



**Fig. 2
16-045**



**Fig. 3
16-046**



**Fig. 4
16-047**



**Fig. 5
16-048**



**Fig. 6
16-049**



**Fig. 7
16-050**



**Fig. 8
16-051**



**Fig. 9
16-052**



**Fig. 10
16-053**



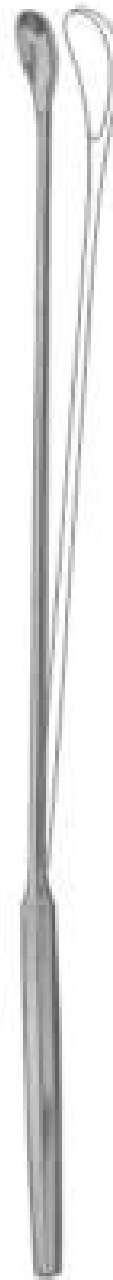
**Fig. 11
16-054**



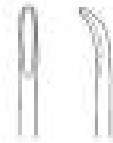
**Fig. 12
16-055**



**Fig. 13
16-056**



**Luer-Koerte
Modif With
Malleable Shaft
16-057
31 cm**



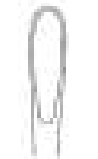
**16-058
2.8mm
Fig. 000**



**16-059
3.4mm
Fig. 00**



**16-060
4.3mm
Fig. 0**



**16-061
5.5mm
Fig. 1**



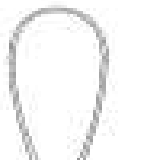
**16-062
6.7mm
Fig. 0**



**16-063
8.0mm
Fig. 3**



**16-064
11mm
Fig. 4**



**16-065
15mm
Fig. 5**

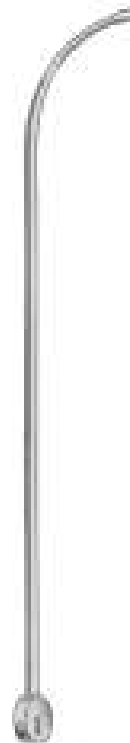


Catheter
16-068
15 cm
No. 6-16

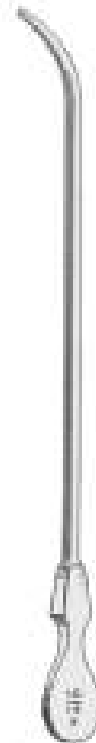


Catheters 29 cm
Male Catheters chart. Metal

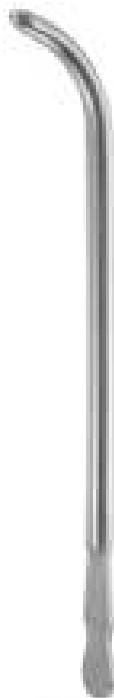
- French
- 16-067 8
 - 16-068 10
 - 16-069 12
 - 16-070 14
 - 16-071 16
 - 16-072 18
 - 16-073 20



Lister Bougies
16-074
27 cm
00 / 1 to 15 / 18
set of 17



Clifton Bougies
16-075 27 cm
00 / 10 FG to 28 / 32
set of 12



Van Buren
Urethral Sound
16-076
A to O
Set of 15

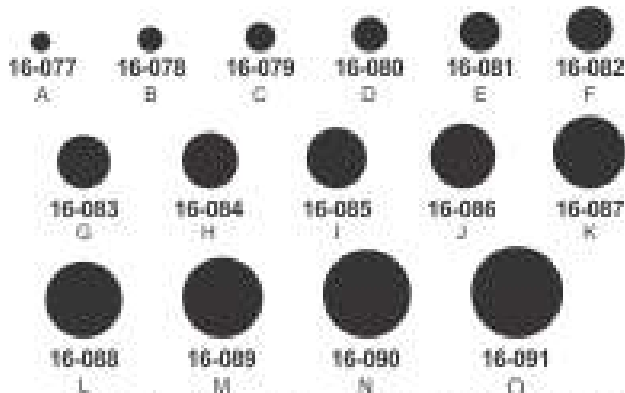
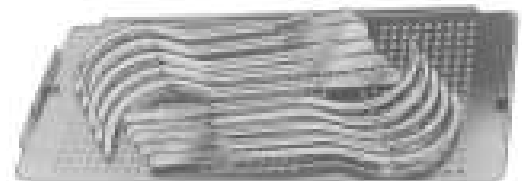
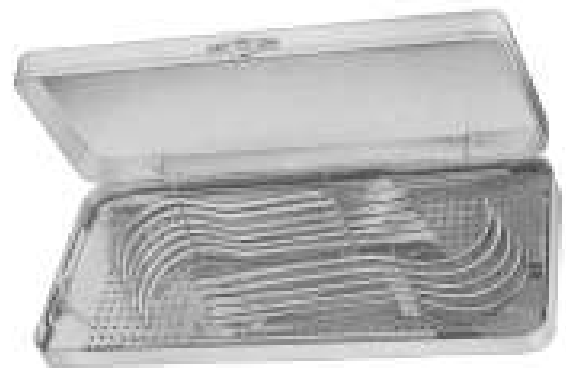


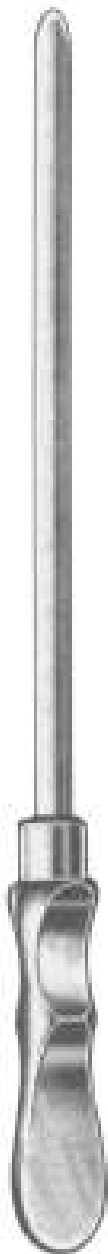
Fig.	Item	Description	Inches	Dia. Char.
A	16-077	28 cm	11"	8 French
B	16-078	28 cm	11"	10 French
C	16-079	28 cm	11"	12 French
D	16-080	28 cm	11"	14 French
E	16-081	28 cm	11"	16 French
F	16-082	28 cm	11"	18 French
G	16-083	28 cm	11"	20 French
H	16-084	28 cm	11"	22 French
I	16-085	28 cm	11"	24 French
J	16-086	28 cm	11"	26 French
K	16-087	28 cm	11"	28 French
L	16-088	28 cm	11"	30 French
M	16-089	28 cm	11"	32 French
N	16-090	28 cm	11"	34 French
O	16-091	28 cm	11"	36 French



Guyon
16-092
420 x 175 x 40 mm.
Set in metal case containing:
— 21 Bougies Guyon
— 6 filiform Bougies

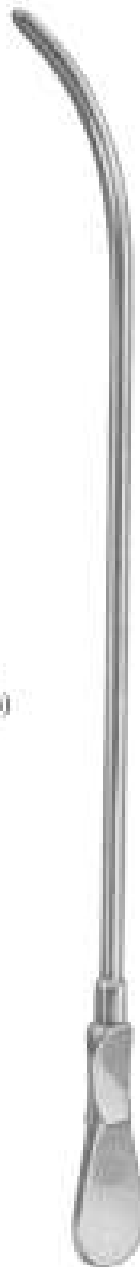
URETHRAL CATHETERS

Urethrokatheter | Cateteri Uretrali
 Sondes Urétrales | Cateteres Uretrales



Dittel
22.5 cm
urethral bougies and
dilating sounds

Char. (French)	
16-093	8
16-094	9
16-095	10
16-096	11
16-097	12
16-098	13
16-099	14
16-100	15
16-101	16
16-102	17
16-103	18
16-104	19
16-105	20
16-106	21
16-107	22
16-108	23
16-109	24
16-110	25
16-111	26
16-112	27
16-113	28
16-114	29
16-115	30



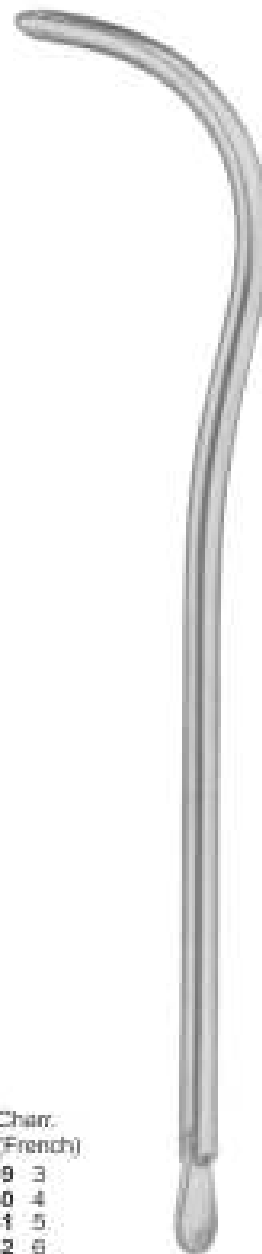
Dittel
35 cm
urethral bougies and
dilating sounds

Char. (French)	
16-116	8
16-117	9
16-118	10
16-119	11
16-120	12
16-121	13
16-122	14
16-123	15
16-124	16
16-125	17
16-126	18
16-127	19
16-128	20
16-129	21
16-130	22
16-131	23
16-132	24
16-133	25
16-134	26
16-135	27
16-136	28
16-137	29
16-138	30



33 cm
filiform guides,
olive tip

Char. (French)	
16-139	3
16-140	4
16-141	5
16-142	6



Guyon
16-143
25 cm
Set
urethral bougies and
dilating sounds
without filiform guides,
with thread in tip

Char. (French)	
16-144	Ben. 24 / Char. 12 Ben. 25
16-145	Ben. 26 / Char. 13 Ben. 27
16-146	Ben. 28 / Char. 14 Ben. 29
16-147	Ben. 30 / Char. 15 Ben. 31
16-148	Ben. 32 / Char. 16 Ben. 33
16-149	Ben. 34 / Char. 17 Ben. 35
16-150	Ben. 36 / Char. 18 Ben. 37
16-151	Ben. 38 / Char. 19 Ben. 39
16-152	Ben. 40 / Char. 20 Ben. 41
16-153	Ben. 42 / Char. 21 Ben. 43
16-154	Ben. 44 / Char. 22 Ben. 45
16-155	Ben. 46 / Char. 23 Ben. 47
16-156	Ben. 48 / Char. 24 Ben. 49
16-157	Ben. 50 / Char. 25 Ben. 51
16-158	Ben. 52 / Char. 26 Ben. 53
16-159	Ben. 54 / Char. 27 Ben. 55
16-160	Ben. 56 / Char. 28 Ben. 57
16-161	Ben. 58 / Char. 29 Ben. 59
16-162	Ben. 60 / Char. 30

Blasensperrer, Blasenwundsperrer

or para el cuello vesical, Separadores vesicales

Ecarteur pour le col de la vessie, Ecarteurs vésicaux

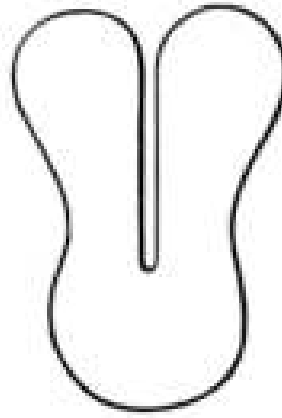
Divaricatore del collo vescicale, Divaricatore vescicale



Knutson
16-163 18 cm
Urethrographie-Instrument



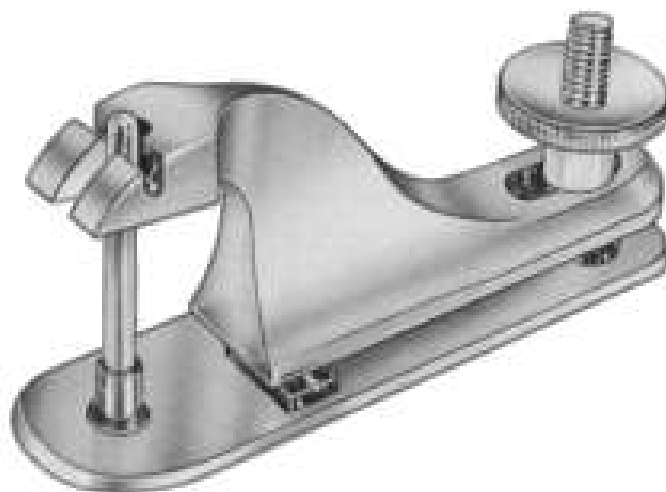
Mogen Circumcision Clamp
16-165



Circumcision Shield
16-166 10cm



Winkelmann Circumcision Clamps
16-167 12 mm Ø
16-168 15 mm Ø
16-169 20 mm Ø



Gumco Circumcision Clamp

	mm Ø
16-170	8
16-171	11
16-172	13
16-173	16
16-174	21
16-175	26
16-176	32



Stockmann Penile Clamp
16-177 8cm

BLADDER NECK SPREADER, BLADDER RETRACTORS

Blasenhalsperrer, Blasenrundsperre

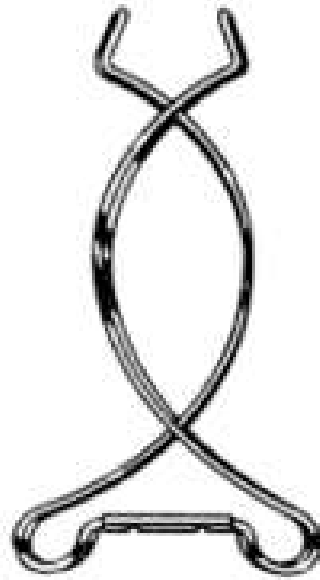
Dilatador para el cuello vesical, Separadores vesicales

Ecarteur pour le col de la vessie, Ecarteurs vés

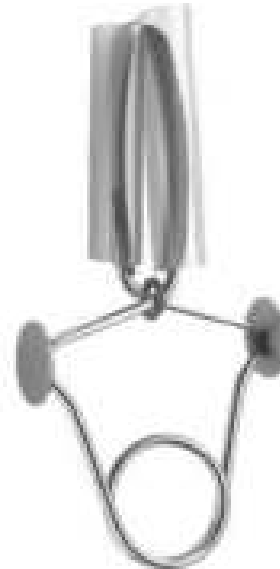
Divaricatori del collo vescicale, Divaricatori v



**Millin Bladder
Neck Spreader**
16-178
28 cm



Zieser Meatus Clamp
16-179 10cm



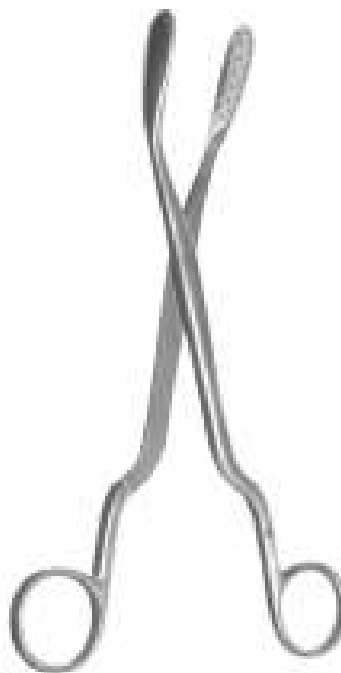
**Strauss Penile
Clamp**
16-180 11cm



**Thomson Walker
Penile Clamp**
16-181



**Lewkowitz Lithotomy
Forceps**
16-182 26cm Str.



**Lewkowitz Lithotomy
Forceps**
16-183 26cm Cvd



**Young Lobe Holding
Forceps**
16-184 20cm

Blasensperrer, Blasenwundsperrer

or para el cuello vesical, Separadores vesicales

Ecarteur pour le col de la vessie, Ecarteurs vésicaux

Divaricatore del collo vescicale, Divaricatore vescicale



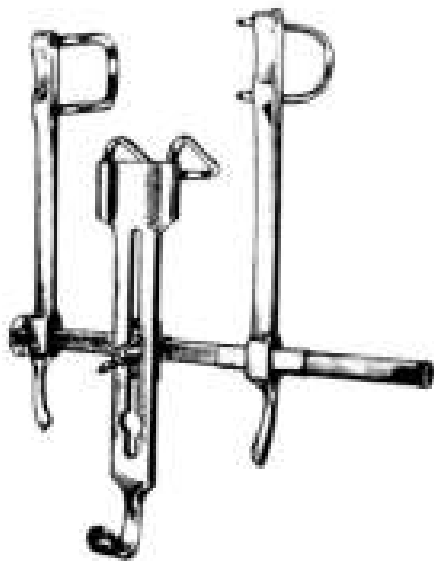
Legueu Bladder Spatula
16-185



Gossel Bladder Retractor
16-186 160mm



Thomson Walker Bladder Retractor
16-187



Pantings Bladder Retractor
16-188



Judd Masson Bladder Retractor
16-189
w/center blade



Millin Bladder Retractor
16-190

HERNIA DIRECTOR, VASECTOMY FORCEPS, CLAMP & BLADDER RETRACTOR

Leistenbruch Director, Vasectomie Zange, Schraubstock & Blase Retractor
Directora Hernia, Pinzas vasectomia, ahrosadora y la vejiga retractor

Director de hernia, Pinzas de vasectomia, Clamp et la vessie
Directore Ernia, Pinze vasectomia, Clamp & vesicla Directorat



Child Hernia Director
16-191



Key Hernia Director
16-192



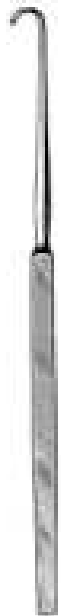
Teale Hernia Director
16-193



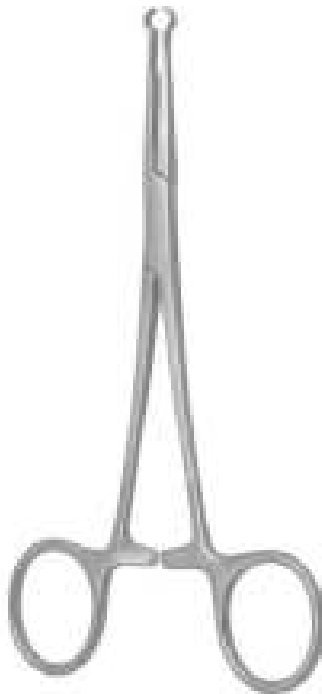
Millin Suction Tube
16-194



Cord Hook
16-195
blunt 16cm



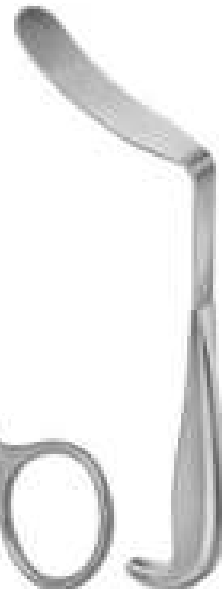
Gutmann Secretions Scoop
16-196 26cm



No Scalpel Vasectomy Ringed Forceps Clamps
16-197 14cm



No Scalpel Vasectomy Hemostat Forceps
16-198 34cm
smooth sharp point curved



Leguau Bladder Retractor
16-199
27cm

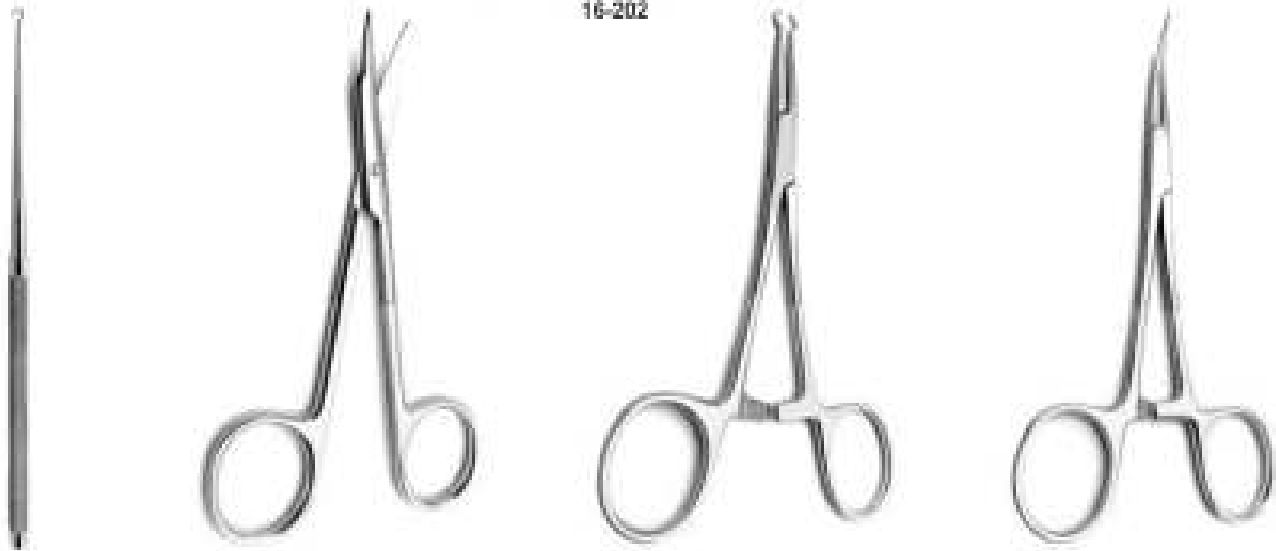


Kocher's Bladder Retractor
16-200 23.5 cm

**RECTUM VASECTOMY SET OF 4 PCS
16-201**



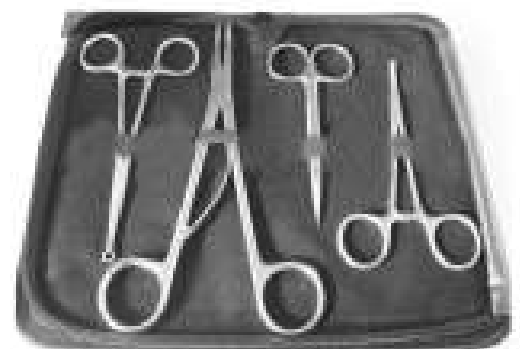
**RECTUM VASECTOMY SET OF 4 PCS
16-202**



**RECTUM VASECTOMY SET OF 2 PCS
16-203**



**RECTUM VASECTOMY SET OF 3 PCS
16-204**

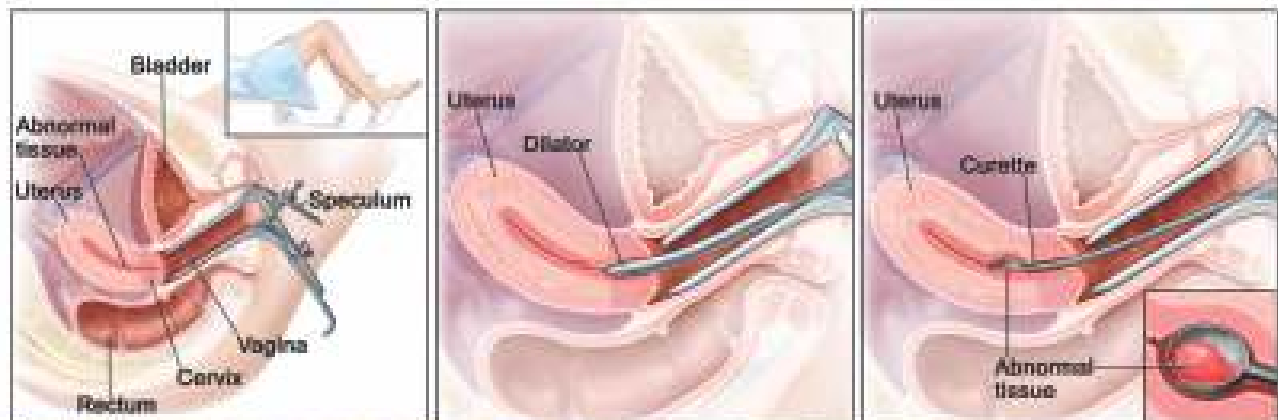


**RECTUM VASECTOMY SET OF 4 PCS
16-205**

GYNECOLOGY/OBSTETRICS INSTRUMENTS



Dilatation and Curettage





Cusco vaginal speculum
17-001 75 mm x 32 mm
17-002 85 mm x 35 mm
17-003 100 mm x 35 mm
17-004 75 mm x 17 mm
for virgins



Cusco vaginal speculum
17-005 75 mm x 32 mm
17-006 80 mm x 35 mm
17-007 100 mm x 37 mm



Cusco vaginal speculum
17-008 80 mm x 22 mm
17-009 100 mm x 25 mm
17-010 105 mm x 27 mm
Swiss pattern



Grave vaginal speculum
17-011 75 mm x 20 mm
17-012 95 mm x 35 mm
17-013 115 mm x 35 mm



Pederson vaginal speculum
17-014 75 mm x 13 mm
17-015 100 mm x 22 mm
17-016 120 mm x 25 mm



Winterton
17-017



Trelat vaginal speculum
17-018 85 mm x 30 mm
17-019 95 mm x 35 mm
17-020 115 mm x 43 mm



Vaginal Speculum-Cusco
17-021 Extra Small
17-022 Small
17-023 Medium
17-024 Medium-Extra long
17-025 Large



Semm vaginal speculum
17-026 90 mm x 14 / 18 mm
17-027 100 mm x 17 / 20 mm
17-028 110 mm x 25 / 30 mm

VAGINAL SPECULUM

Scheidenspekulum | Espécúlo vaginal
Spéculum vaginal | Speculum vaginale



Collin vaginal speculum
17-029 85 mm x 30 mm
17-030 100 mm x 35 mm
17-031 110 mm x 40 mm



COLLIN
17-032
55 x 10 mm



NOTT
17-033 90 mm x 30 mm
17-034 100 mm x 30 mm



DE VILBISS
17-035
4 x 27 mm
102 mm x 32 mm
Medium



SEYFFERT
17-036 100 x 24 mm
17-037 110 x 32 mm
23 cm, 9"



CUSCO
17-038 75 x 32 mm
17-039 85 x 35 mm
17-040 100 x 35 mm



CUSCO
17-041 75 x 17 mm



CUSCO
17-042 90 x 22 mm
17-043 100 x 25 mm
17-044 105 x 27 mm



GRAVES
Virgin Speculaums
Color Coated, Straight
17-045 20mm x 75mm, Small
17-046 35mm x 95mm, Medium
17-047 35mm x 115mm, Large



Graves Vaginal Speculum Leep / Lietz
17-048 Small
17-049 Medium
17-050 Large
17-051 X-large



Pederson Vaginal Speculum Leep / Lietz
17-052 Small
17-053 Medium
17-054 Large
17-055 X-Large



PEDERSON
Virgin Speculaums
Color Coated
17-056 17mm x 100mm, Narrow
17-057 13mm x 75mm, Small
17-058 22mm x 100mm, Medium
17-059 25mm x 120mm, Large



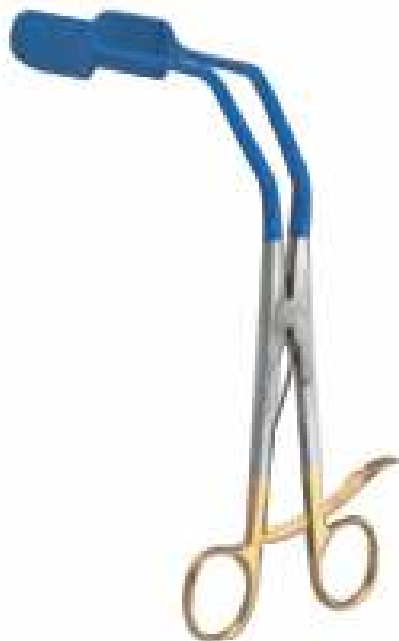
NEW PORT
17-060
25 cm



Lateral Vaginal Retractor
17-061
21 cm



Lateral Vaginal Retractor Blue Coated Loop / Lietz
17-062 21 cm



Side Wall Retractors
17-063 4-Sided Pederson Speculum, Medium
17-064 4-Sided Pederson Speculum, Large
Redundant Wall Retractor, 3.5 in. x .75 in. blades
Lateral/Wall Retractor, Closed Shanks, 2.25 in. blades
Lateral/Wall Retractor/Open Shanks, 2.5 in. blades



Lateral Vaginal Retractor Blue Coated
17-065 26cm



McGee Lateral Vaginal Retractor With Ratchet Handle
17-066 20cm

VAGINAL SPECULUM

Scheidenspekulum | Espécua vaginal
Speculum vaginal | Speculum vaginale



Kogan Speculum
17-067
24 cm
with scale-ratchet
and fixation screws



Kogan Speculum
17-068
24 cm



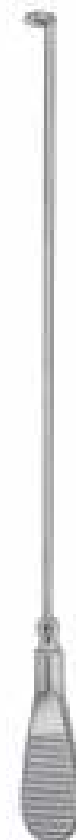
Kogan - Modif.
Speculum
28 cm
17-069
x=4 mm y=8mm
17-070
x=2 mm y=4mm



Kogan Endocervical Spatula
17-071
Ratchet, Standard Tips, 28cm
Ratchet, Narrow Tips, 28cm
Set Screw, Standard Tips, 28cm
Set Screw, Narrow Tips, 28cm



RAMATHIBOOI
17-072
27.5 cm
Uterine Manipulator



RAMATHIBOOI
17-073
25 cm
Tubal hook



Kristeller Speculum
17-074 70 mm x 27 mm
17-075 80 mm x 30 mm
17-076 90 mm x 36 mm
17-077 110 mm x 27 mm
17-078 110 mm x 30 mm
17-079 110 mm x 36 mm



Kristeller Retractor
17-080 75 mm x 23 mm
17-081 85 mm x 26 mm
17-082 100 mm x 32 mm
17-083 115 mm x 23 mm
17-084 115 mm x 26 mm
17-085 115 mm x 32 mm



Kristeller Speculum & Retractor
17-086 75 mm x 23 mm
17-087 85 mm x 26 mm
17-088 100 mm x 32 mm
17-089 115 mm x 23 mm
17-090 115 mm x 26 mm
17-091 115 mm x 32 mm



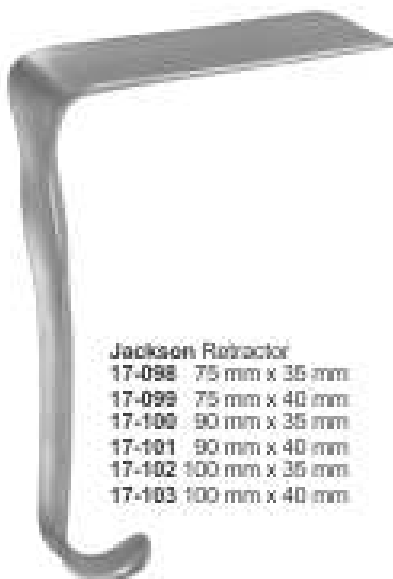
Kristeller Speculum
17-092 105 mm x 18 mm
17-093 105 mm x 21 mm
Speculum tapered, for virgins



Kristeller Retractor
17-094 110 mm x 14 mm
17-095 115 mm x 17 mm



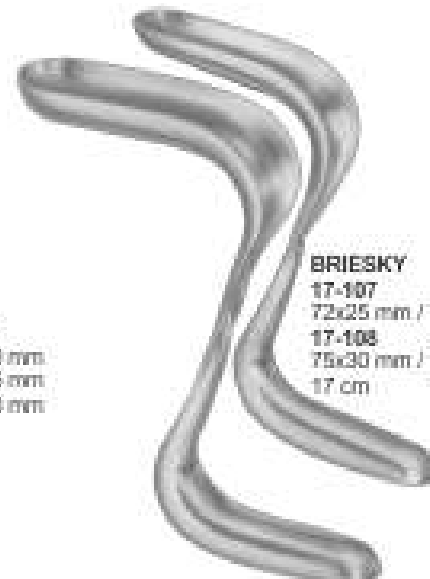
Kristeller Speculum & Retractor
17-096 110 mm x 14 mm
17-097 115 mm x 17 mm



Jackson Retractor
17-098 75 mm x 35 mm
17-099 75 mm x 40 mm
17-100 90 mm x 35 mm
17-101 90 mm x 40 mm
17-102 100 mm x 35 mm
17-103 100 mm x 40 mm



Sims Speculum & Retractor
17-104 70 mm x 25 mm / 30 mm
17-105 75 mm x 30 mm / 35 mm
17-106 80 mm x 35 mm / 40 mm



BRIESKY
17-107
72x25 mm / 77x30 mm
17-108
75x30 mm / 92x38 mm
17 cm

VAGINAL SPECULUM AND RETRACTORS



Vaginalspekulum und Retraktoren
 Spéculum et écarteurs vaginaux

Espéculo vaginal y retractores
 Speculum vaginale e divaricatori



Kallmorgen Speculum
 17-109 70 mm x 40 mm
 17-110 90 mm x 40 mm



Kallmorgen & Retractor
 17-111 70 mm x 33 mm
 17-112 90 mm x 33 mm



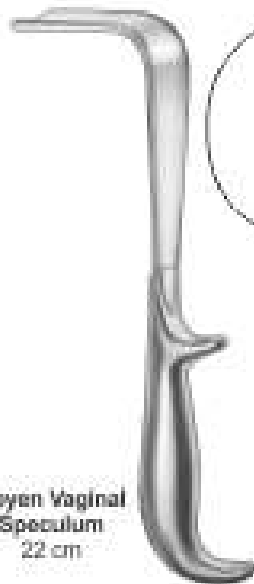
Kallmorgen Speculum & Retractor
 17-113 70 mm x 33 mm
 17-114 90 mm x 33 mm



MATHIEU Vaginal Speculum
 17-115
 Set 100x13mm-23mm
 17-116
 95x16mm-26mm
 17-117
 95x26mm-30 mm
 21 cm



MATHIEU Vaginal Retractor
 17-118
 Set 100x17mm-30mm
 17-119
 100x11mm-20mm
 17-120
 100x14mm-26mm
 22 cm



Doyen Vaginal Speculum
 22 cm

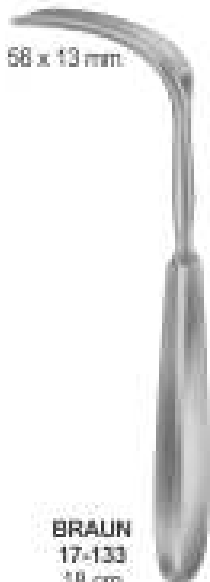


Slightly Concave

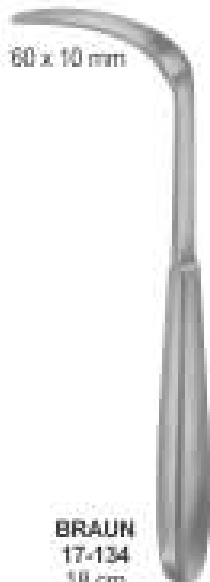
- 17-121 60 x 35 mm
- 17-122 90 x 35 mm
- 17-123 120 x 35 mm
- 17-124 60 x 45 mm
- 17-125 90 x 45 mm
- 17-126 120 x 45 mm
- 17-127 160 x 45 mm
- 17-128 60 x 60 mm
- 17-129 90 x 60 mm
- 17-130 120 x 60 mm
- 17-131 160 x 60 mm



Landon Vaginal Retractor
 17-132
 Blade 9 cm
 Deep 2.5 cm wide



BRAUN
 17-133
 18 cm



BRAUN
 17-134
 18 cm

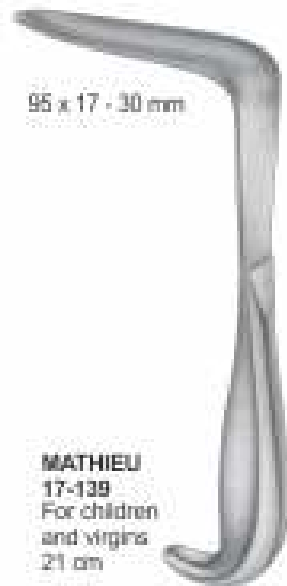


17-135
 Handle with cold light carrier for upper blades
 28 cm



17-136
 115 x 22 mm
17-137
 115 x 25 mm

SIMON
 115 x 22 mm
 27.5 cm

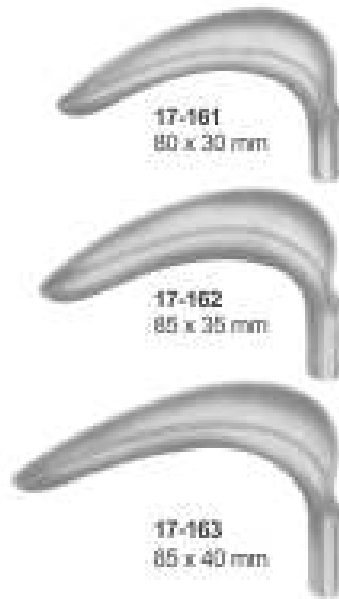


VAGINAL SPECULUM

Scheidenspekulum | Espécua vaginal
 Speculum vaginal | Speculum vaginale



**Scherback Speculum
 17-160**
 Set consisting of:
 handle weight 5 blades



17-161
 80 x 30 mm

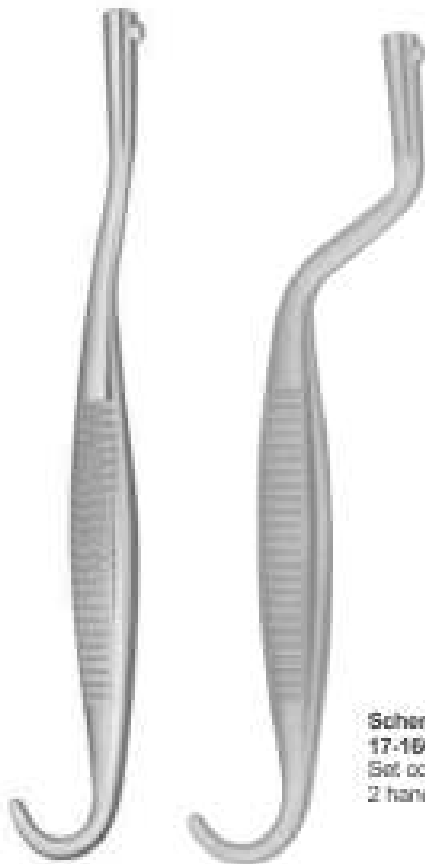
17-162
 85 x 35 mm

17-163
 85 x 40 mm



17-164
 55 x 40 - 60 mm

17-165
 70 x 45 - 70 mm



**Scherback Speculum
 17-166**
 Set consisting of:
 2 handle, 8 blades



17-167
 80 x 30 mm

17-168
 85 x 33 mm

17-169
 100 x 38 mm

17-170
 110 x 42 mm



17-171
 85 x 30 mm

17-172
 75 x 35 mm

17-173
 85 x 35 mm

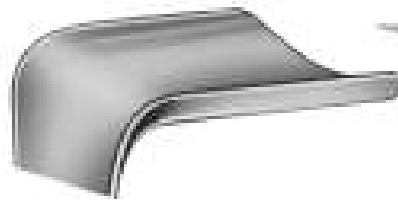
17-174
 95 x 35 mm



Doyen
speculum and retractor
24 cm slightly concave
17-175 55 mm x 35 mm
17-176 75 mm x 35 mm
17-177 115 mm x 35 mm

17-178 55 mm x 45 mm
17-179 75 mm x 45 mm
17-180 115 mm x 45 mm
17-181 160 mm x 45 mm

17-182 55 mm x 60 mm
17-183 75 mm x 60 mm
17-184 115 mm x 60 mm
17-185 160 mm x 60 mm



Doyen
speculum and retractor
24 cm medium concave
17-186 55 mm x 35 mm
17-187 75 mm x 35 mm
17-188 115 mm x 35 mm

17-189 55 mm x 45 mm
17-190 75 mm x 45 mm
17-191 115 mm x 45 mm

17-192 55 mm x 60 mm
17-193 75 mm x 60 mm
17-194 115 mm x 60 mm



17-195
60 x 45 mm

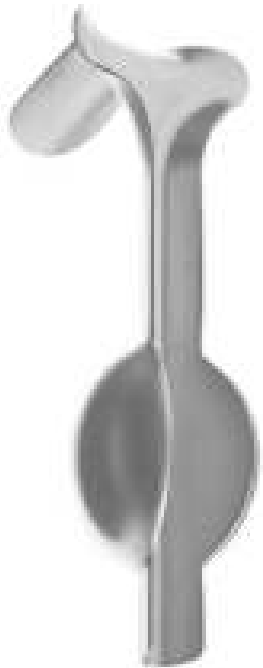


17-196
90 x 45 mm

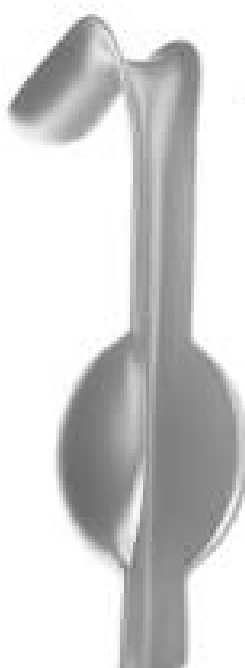


17-197
112 x 45 mm

DOYEN
Speculum & Retractor
23.5 cm



**Garrigue Weighted
Vaginal Speculum**
17-198 4.0 cm x 8.0 cm
Weight 2 lbs.



**Henrotin Weighted
Vaginal Speculum**
17-199 3.8 cm x 9.0 cm
Weight 3 lbs.



AUNARD,
speculum & retractor
17-200
80 x 38 mm - 28 mm
1,530 kg
with fixed weight
23 cm



AUNARD
speculum & retractor
17-201 75 x 42 mm
17-202 80 x 43 mm
(40 mm)
17-203 105 x 43 mm
(40 mm)
with detachable weight
23 cm



WEISSBARTH
speculum & retractor
17-204 80 x 28 mm
17-205 85 x 42 mm
21 cm

VAGINAL SPECULUM

Scheidenspekulum | Espéculo vaginal
 Speculum vaginal | Speculum vaginale



AUVARD
17-206
 65 x 38 mm - 28 mm
 1.530 kg
 with fixed weight
 23 cm

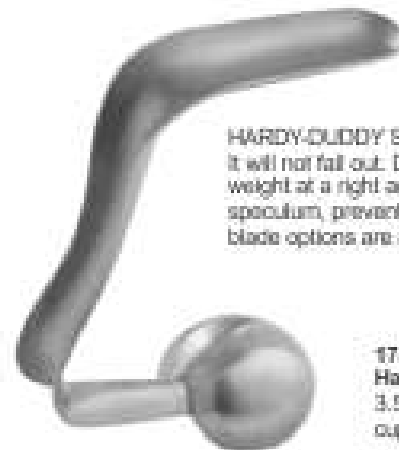


MARTIN
17-207
 with hook shaped
 handle for hanging
 in weights
 27 cm



STEINER SPECULUM
 Ideal for deep vaginal surgery.
 Blades may be ordered from
 4" to 7", 5.5" is normal length.

17-208
 1.1 Kg / 2.5 lb.
 14 cm x 3 cm



HARDY-DUDDY SPECULUM
 It will not fall out. Design places the 3.5 lbs
 weight at a right angle to the shaft of the
 speculum, preventing expulsion. Many
 blade options are available.

17-209
Hardy-Duddy Speculum,
 3.5 lbs., 120 mm x 35 mm
 cupped blade



AUVARD SPECULUM
 An assortment of weighted
 Auvard specula is available.

17-210
 1.1 Kg / 2.5 lb.
 8.5 cm x 4 cm
17-211
 1.1 Kg / 2.5 lb.
 10 cm x 4.5 cm



**NICHOLS WEIGHTED
 SPECULUM**
 Permits retraction of posterior
 vaginal wall, while providing
 suction and measurement of
 fluids from the surgical site.

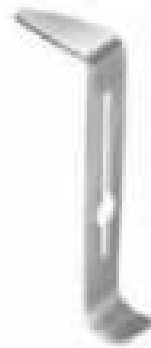
17-212
Nichols/VaginaWeighted Speculum
 with Suction, 2.5 lbs. 7cm x 3.8cm

VAGINAL RETRACTORS

Vaginal Retraktoren | Retractores vaginales
Ecarteurs vaginaux | Divaricatori vaginali



**O'Sullivan - O'Connor
Vaginal Retractor**
17-213 - Set of 3 Complete



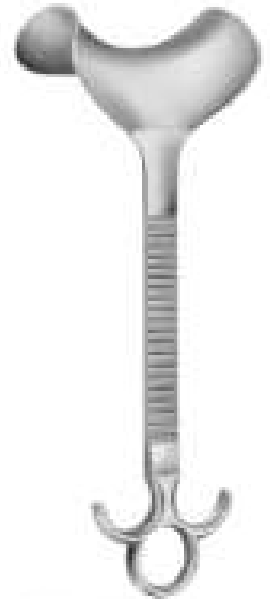
17-214
45 x 17 mm



17-215
50 x 45 mm



17-216
90 x 37 mm



Abdominal Retractor
17-217 9 cm wide
17-218 10 cm wide
17-219 11.5 cm wide

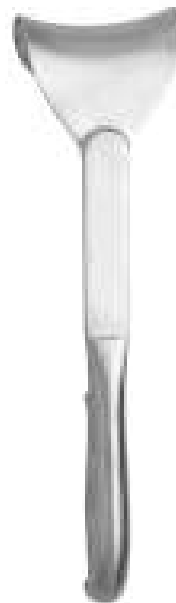


Friedmann Retractor
17-220
10 cm



COMYN BERKELEY
Vulva Self Retaining

17-221
15.5cm



DOYEN
Supra Hollow Handle
17-222 7.5mm x 28cm
17-223 9mm x 28cm
17-224 10mm x 28cm
17-225 11.5mm x 28cm



DOYEN POZZI
Retractor
17-226 4.5mm x 5mm x 25.5cm
17-227 4.5mm x 5mm x 25.5cm
17-228 4.5mm x 11.5mm x 25.5cm

CERVICAL BIOPSY AND SPECIMEN FORCEPS



Probeexistenzsangen

Pinzas saca-bocados para biopsia

Pinces emporte-pièces à biopsie

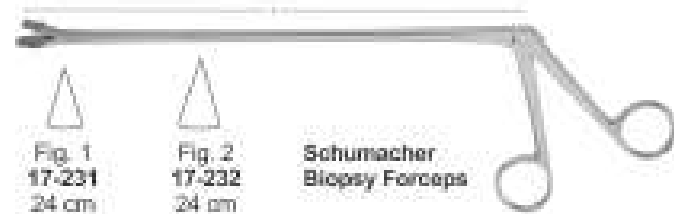
Pinze taglianti per biopsia



Berger
Biopsy and Specimen Forceps
17-229
x = 200 mm



Eppendorfer
Biopsy and Specimen Forceps
17-230
x = 200 mm



Schumacher
Biopsy Forceps
Fig 1 17-231 24 cm
Fig 2 17-232 24 cm



Kevorkian
Biopsy and Specimen Forceps
17-233
x = 245 mm



Alexander
Biopsy and Specimen Forceps
17-234 28 cm
x = 200 mm



Wittner Biopsy and Specimen Forceps
17-235 x = 230 mm straight
Wittner Biopsy and Specimen Forceps
17-236 x = 230 mm curved



Schumacher
Biopsy and Specimen Forceps
17-237 x = 23 cm complete
17-238 x = 23 cm sp



Tischler - Morgan
Biopsy and Specimen Forceps
USA Model 17-239 x = 200 mm
17-240 x = 250 mm
Tischler - Morgan
Biopsy and Specimen Forceps
17-241 x = 200 mm
17-242 x = 250 mm

Instruments as illustrated, but without locking screw.

USA Model



Mini - Tischler
Biopsy and Specimen Forceps
17-243 x = 200 mm
17-244 x = 250 mm
Mini - Tischler
Biopsy and Specimen Forceps
17-245 x = 200 mm
17-246 x = 250 mm

Instruments as illustrated, but without locking screw.



Wittner Biopsy Forceps
17-247 23cm Shaft Straight
Wittner Biopsy Forceps
17-248 23cm Shaft Angled



Schumacher Biopsy Forceps
17-249 Small Jaw 24cm Shaft
Schumacher Biopsy Forceps
17-250 Large Jaw 24cm Shaft



Tischler Baby Biopsy Forceps
17-251 21.5cm Shaft

Probeexcisionszangen

Pinças saca-bacados para biopsia

Pinces emporte-pièces à biopsie

Pinze taglianti per biopsia



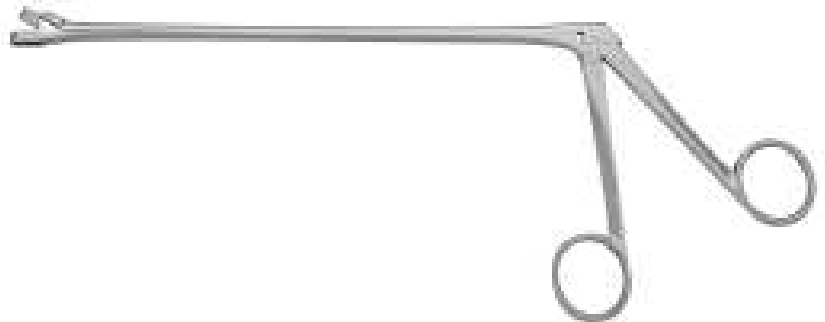
Tischler Biopsy Forceps
17-252
21.5cm Shaft



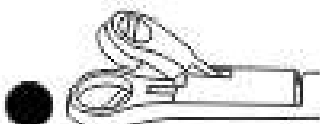
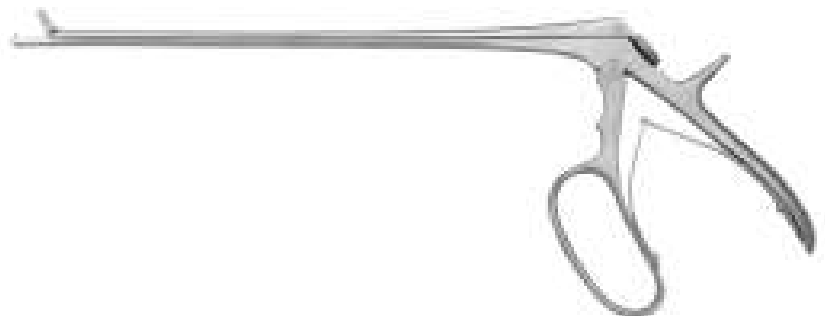
Burke Biopsy Forceps
17-253
21.5cm Shaft



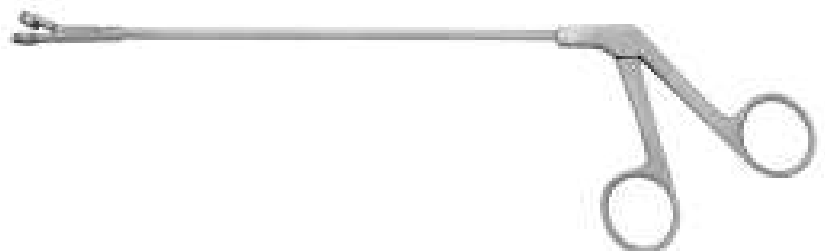
Eppendorf Biopsy Forceps
17-254
20cm Shaft



Kavorkian Young Biopsy Forceps
17-255
25.5cm Shaft



Leachwilkinson Biopsy Forceps
17-256
20cm Shaft Round



CERVICAL BIOPSY AND SPECIMEN FORCEPS

Probeexistenzsaengen
Pinças emponte-pièces à biopsie

Pinças saca-bocados para biopsia
Pinze taglianti per biopsia



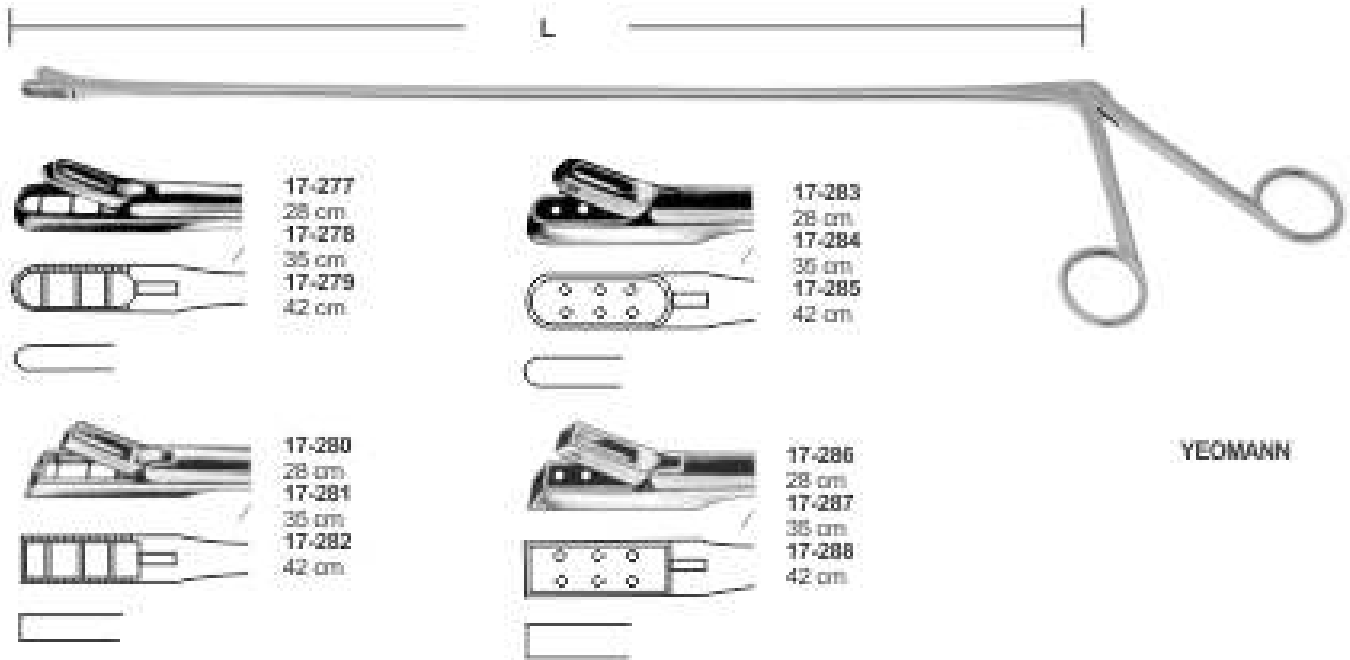
Uni - Tischler Biopsy and Specimen Forceps 17-258 3 x 7 mm Straight, Tip only	Uni - Tischler Biopsy and Specimen Forceps 17-259 3 x 7 mm up, Tip only	Uni - Tischler Biopsy and Specimen Forceps 17-260 3 x 7 mm down, Tip only	Biopsy and Specimen Forceps Handle only 17-257
Uni - Townsend Biopsy and Specimen Forceps 17-261 2.3 x 4 mm straight, Tip only	Uni - Townsend Biopsy and Specimen Forceps 17-262 2.3 x 4 mm up, Tip only	Uni - Townsend Biopsy and Specimen Forceps 17-263 2.3 x 4 mm down, Tip only	Uni - Kavorkian Biopsy and Specimen Forceps 17-264 3 x 9 mm Tip only
	Uni - Oval Biopsy and Specimen Forceps 17-265 3 x 5 mm Tip only		Uni - Burke Biopsy and Specimen Forceps 17-266 3 x 5 mm Tip only
Uni - Tischler Biopsy and Specimen Forceps 17-268 3 x 7 mm Straight, Tip only	Uni - Tischler Biopsy and Specimen Forceps 17-269 3 x 7 mm up, Tip only	Uni - Tischler Biopsy and Specimen Forceps 17-270 3 x 7 mm down, Tip only	Biopsy and Specimen Forceps Handle only 17-267
Uni - Townsend Biopsy and Specimen Forceps 17-271 2.3 x 4 mm straight, Tip only	Uni - Townsend Biopsy and Specimen Forceps 17-272 2.3 x 4 mm up, Tip only	Uni - Townsend Biopsy and Specimen Forceps 17-273 2.3 x 4 mm down, Tip only	Uni - Kavorkian Biopsy and Specimen Forceps 17-274 3 x 9 mm Tip only
	Uni - Oval Biopsy and Specimen Forceps 17-275 3 x 5 mm Tip only		Uni - Burke Biopsy and Specimen Forceps 17-276 3 x 5 mm Tip only

lange, Darm-anastomosenklemmen

Pinze Pour Saisir Polypes, Pinces-clamps Pour Anastomose Intestinale

liger Polipos, Clamps Para Anastomosis Intestinales

Pinze Per Afferrare Polipi, Pinze Per Anastomosi Intestinali



PILE FORCEPS

COTTON CARRIER



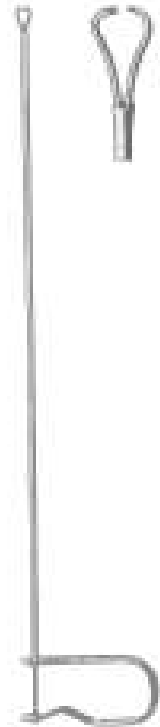
LURE
17-289
24.5cm



JARVIS
17-290
23cm



LANGENBECK
17-291
45cm



17-292
45cm

CERVICAL BIOPSY AND SPECIMEN FORCEPS



Probeexzisionszangen

Pinzas saca-bocadas para biopsia

Pinces emporte-pièces à biopsie

Pinze taglienti per biopsia



**Schubert
Biopsy Forceps**
17-293 21 cm
17-294 28 cm



**Faure Uterine
Biopsy Forceps**
17-295 21 cm



**Schubert
Biopsy Forceps**
17-296 26 cm



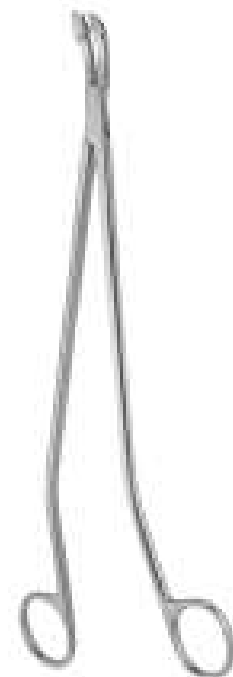
**Gellhorn
Biopsy Forceps**
17-297 23 cm



**Thoms-Gaylor
Biopsy Forceps**
17-298 22 cm
17-299 24 cm



**Van Doren
Biopsy Forceps**
17-300 24 cm



**Schumacher
Biopsy Forceps**

Fig. 1
17-301
24 cm

Fig. 2
17-302
24 cm

Hakenzangen

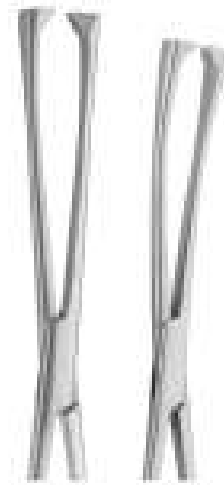
Pinzas para coger el cuello del útero

Pinces pour l'abaissement du col de l'utérus

Pinze per abbassare il collo dell'utero



Museux Tenaculum Forceps



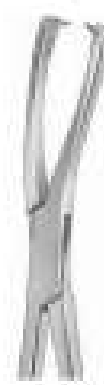
24 cm
17-303
8 mm
17-304
6 mm
17-305
10 mm
Straight

24 cm
17-306
8 mm
17-307
6 mm
17-308
10 mm
Curved



Jacobs Uterine Vulsellum Forceps

17-309
21 cm



17-310
21 cm



WINTER
17-311 Fig. 1
17-312 Fig. 2
17-313 Fig. 3
28 cm



Teale Tenaculum Forceps
17-314 23 cm



Pratt Tenaculum Forceps
17-315 26 cm



Czerny Tenaculum Forceps
17-316 20.5 cm



Schroeder Vulsellum Tenaculum Forceps

17-317 24 cm
17-318 24 cm

TENACULUM FORCEPS

Hakensangen

Pinzas para coger el cuello del útero

Pinces pour l'abaissement du col de l'utérus

Pinze per abbassare il collo dell'utero



Pozzi Tenaculum Forceps
17-319 25.5 cm

Schroeder Tenaculum Forceps
17-320 25 cm

Duplay Tenaculum Forceps
17-321 28 cm

Iowa Tenaculum Forceps
17-322 26 cm

Skene Tenaculum Forceps
17-323 24 cm



Beacham Amniotome
17-324
28 cm

Staude - Moore Tenaculum Forceps
17-325 17 cm

Barrett Tenaculum Forceps
17-326 18 cm

Braun Tenaculum Forceps Sharp
17-327 25 cm

Schroeder-Braun Tenaculum Forceps
17-328 25 cm sharp

17-329
Blunt



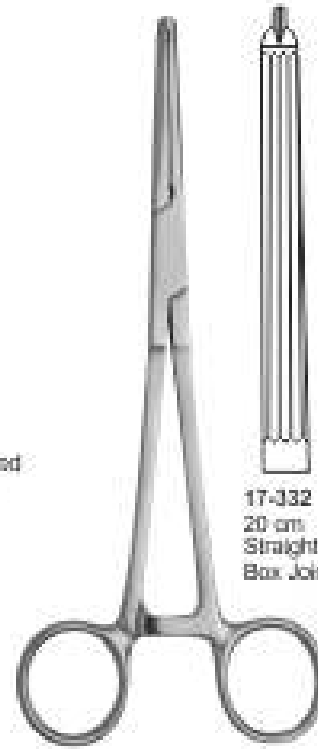
17-330
20 cm
1 x 2th, Angled
Screw Joint

BONNEY



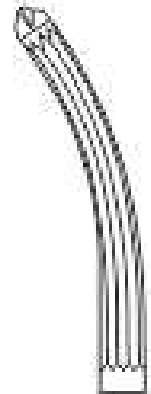
17-331
20 cm
1 x 2th, Curved
Screw Joint

BONNEY-BERKLEY



17-332
20 cm
Straight
Box Joint

GWILLIAM



17-333
20 cm
Curved
Box Joint



17-334
20 cm
Curved
1 tooth
Box Joint

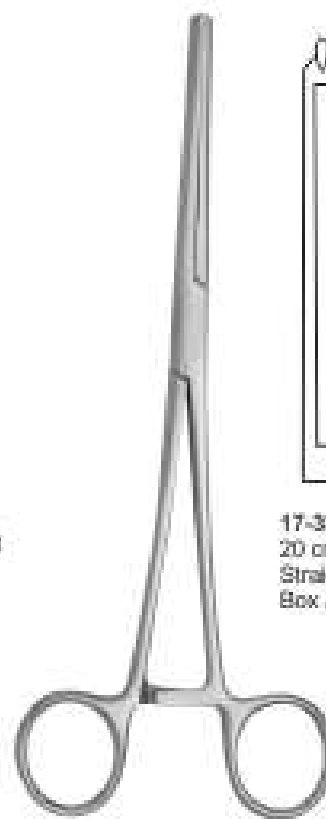
17-335
20 cm
Curved
2 Teeth
Box Joint

HEANEY



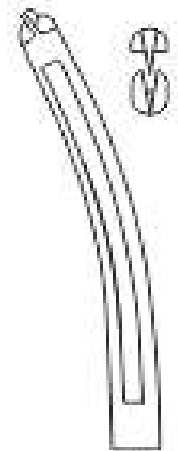
17-336
23 cm
Curved
Box Joint

HUNTER



17-337
20 cm
Straight
Box Joint

MAINGOT



17-338
20 cm
Curved
Box Joint

PARAMETRIUM FORCEPS, HYSTERECTOMY FORCEPS

Parametriumklemmen, Hysterektomieklemmen | Pinzas parametrium, Pinzas-clamps para histerectomia
 Pincas parametrium, Pincas à hysterectomie | Pinze parametrium, Pinze per isterectomia



Parametrium
Hysterectomy
Forceps

17-339
21 cm
17-340
24 cm
17-341
30 cm
17-342
35 cm

17-343
21 cm
17-344
24 cm
17-345
30 cm
17-346
35 cm

17-347
21 cm
17-348
24 cm
17-349
30 cm
17-350
35 cm

17-351
21 cm
17-352
24 cm
17-353
30 cm
17-354
35 cm

17-355
21 cm
17-356
24 cm
17-357
30 cm
17-358
35 cm
S-curved



Rogers Parametrium
Hysterectomy Forceps

17-359
Fig. 1
22 cm

17-360
Fig. 2
21.5 cm

17-361
Fig. 3
21 cm

17-362
Fig. 4
20.5 cm

17-363
Fig. 1
25 cm

17-364
Fig. 2
25 cm

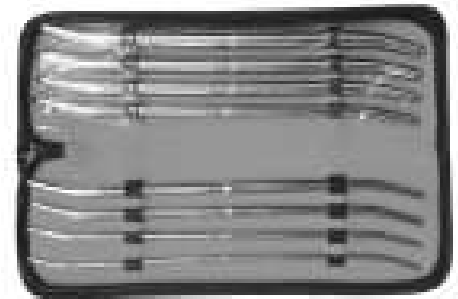
17-365
Fig. 3
24.5 cm

17-366
Fig. 4
23 cm



Hank Uterine Dilators 8 Set
17-367 Complete Set
Curved, Delicate, 11-12 Fr. to 21-22 Fr.
(3.65mm to 7.33cm)

- Hank Uterine Dilators, Double-ended**
- 17-368 11-12 Fr. (3.6mm x 4.0mm), 27.5cm
 - 17-369 13-14 Fr. (4.3mm x 4.7mm), 27.5cm
 - 17-370 15-16 Fr. (5.0mm x 5.3mm), 27.5cm
 - 17-371 17-18 Fr. (5.7mm x 6.0mm), 27.5cm
 - 17-372 19-20 Fr. (6.3mm x 6.7mm), 27.5cm
 - 17-373 21-22 Fr. (7.0mm x 7.3mm), 27.5cm



Pratt Uterine Dilators 8 Set
17-374 Complete Set
Curved, Delicate, 13-15 Fr. to
41-43 Fr., Straight

- Pratt Uterine Dilators, Double-ended**
- 17-375 13 / 15 Fr., 29.5cm
 - 17-376 17 / 19 Fr., 29.5cm
 - 17-377 21 / 23 Fr., 29.5cm
 - 17-378 25 / 27 Fr., 29.5cm
 - 17-379 29 / 31 Fr., 29.5cm
 - 17-380 33 / 35 Fr., 29.5cm
 - 17-381 37 / 39 Fr., 29.5cm
 - 17-382 41 / 43 Fr., 29.5cm



Hegar uterine dilator
17-383 3 / 4 mm - 17 / 18 mm Ø
8 Pieces per set
17-384 1 / 2 mm - 25 / 26 mm Ø
13 Pieces per set

- Hegar uterine dilator**
- 17-385 1 / 2 mm Ø
 - 17-386 3 / 4 mm Ø
 - 17-387 5 / 6 mm Ø
 - 17-388 7 / 8 mm Ø
 - 17-389 9 / 10 mm Ø
 - 17-390 11 / 12 mm Ø
 - 17-391 13 / 14 mm Ø
 - 17-392 15 / 16 mm Ø
 - 17-393 17 / 18 mm Ø
 - 17-394 19 / 20 mm Ø
 - 17-395 21 / 22 mm Ø
 - 17-396 23 / 24 mm Ø
 - 17-397 25 / 26 mm Ø
- double ended

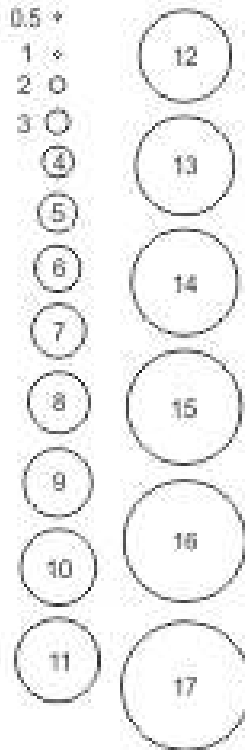


Hegar Uterine Dilators 8 Set w/Roll
17-398 Complete Set
Curved, Delicate, 3mm to 18mm, Curved

- Hegar Uterine Dilator, Double-ended**
- 17-399 3mm & 4mm, (20cm)
 - 17-400 5mm & 6mm, (20cm)
 - 17-401 7mm & 8mm, (20cm)
 - 17-402 9mm & 10mm, (20cm)
 - 17-403 11mm & 12mm, (20cm)
 - 17-404 13mm & 14mm, (20cm)
 - 17-405 15mm & 16mm, (20cm)
 - 17-406 17mm & 18mm, (20cm)

UTERINE DILATORS

Uterusdilataattoren | Dilataadores uterinas
 Dilataateurs uterins | Dilataatori uterini



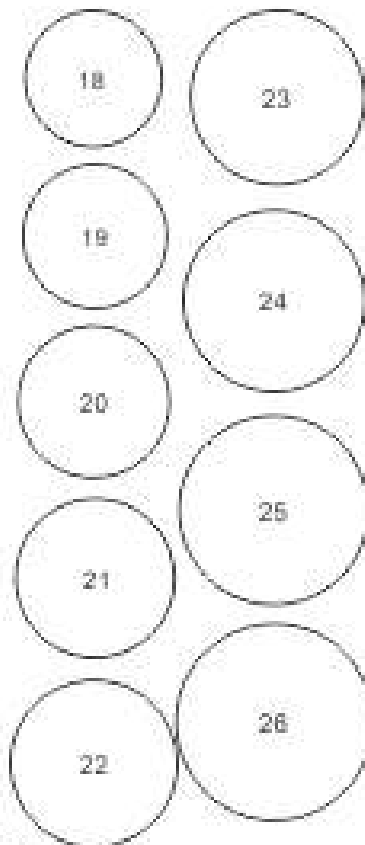
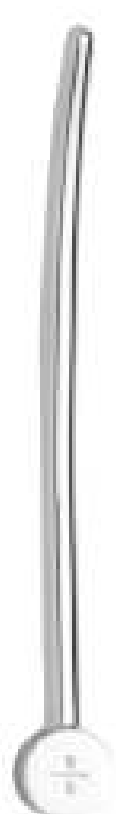
- 17-408 18.5cm 3-4-5mm
 - 17-409 18.5cm 4-5-6mm
 - 17-410 18.5cm 5-6-7mm
 - 17-411 18.5cm 6-7-8mm
 - 17-412 18.5cm 7-8-9mm
 - 17-413 18.5cm 8-9-10mm
 - 17-414 18.5cm 9-10-11mm
 - 17-415 18.5cm 10-11-12mm
 - 17-416 18.5cm 11-12-13mm
 - 17-417 18.5cm 12-13-14mm
 - 17-418 18.5cm 13-14-15mm
 - 17-419 18.5cm 14-15-16mm
 - 17-420 18.5cm 15-16-17mm
 - 17-421 18.5cm 16-17-18mm
 - 17-422 18.5cm 17-18-19mm
 - 17-423 18.5cm 18-19-20mm
- Canvas Roll

Bonney-Barker Dilators
 17-407 Set of 16 Pcs



- 17-425 27cm 9/10mm
- 17-426 27cm 11/12mm
- 17-427 27cm 13/14mm
- 17-428 27cm 15/16mm
- 17-429 27cm 17/18mm
- 17-430 27cm 19/20mm

Hank Double Ended
 17-424 Set of 6 Pcs



- 17-432 17cm 3-6mm
 - 17-433 17cm 4-7mm
 - 17-434 17cm 5-8mm
 - 17-435 17cm 6-9mm
 - 17-436 17cm 7-10mm
 - 17-437 17cm 8-11mm
 - 17-438 17cm 9-12mm
 - 17-439 17cm 10-13mm
 - 17-440 17cm 11-14mm
 - 17-441 17cm 12-15mm
 - 17-442 17cm 13-16mm
 - 17-443 17cm 14-17mm
 - 17-444 17cm 15-18mm
 - 17-445 17cm 16-19mm
 - 17-446 17cm 17-20mm
 - 17-447 17cm 18-21mm
- Canvas Roll Only

Hawkin Ambler Dilators
 17-431
 Set of 16 Pcs



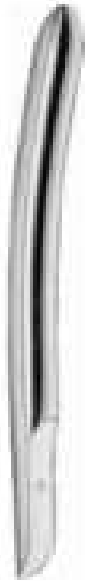
- 20cm 1/2mm
- 20cm 3/4mm
- 20cm 5/6mm
- 20cm 7/8mm
- 20cm 9/10mm
- 20cm 11/12mm
- 20cm 13/14mm
- 20cm 15/16mm
- 20cm 17/18mm
- 20cm 19/20mm
- 20cm 21/22mm
- 20cm 23/24mm
- 20cm 25/26mm
- 17-448 Set 8 Double Ended 3/4mm-17/18mm
- 17-449 Set 12 Double Ended 1/2mm-23/24mm
- 17-450 Set 8 Double Ended Canvas Only
- 17-451 Set 12 Double Ended Canvas Only

Hegar Double Ended Dilators

UTERINE DILATORS

Uterusdilatorenen | Dilatadores uterinos

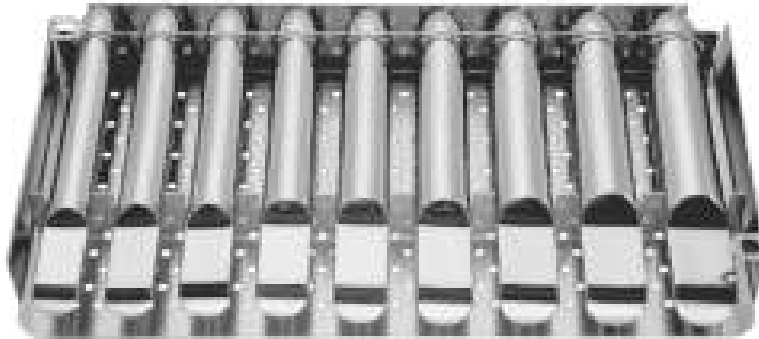
Dilatateurs utérins | Dilatatori uterini



Hagar
with siped handle

Set	mm	pieces per set
17-452	4-17	14
17-453	1-26	26

17-454	1mm Ø	17-484	1.5mm Ø
17-455	2mm Ø	17-485	2.5mm Ø
17-456	3mm Ø	17-486	3.5mm Ø
17-457	4mm Ø	17-487	4.5mm Ø
17-458	5mm Ø	17-488	5.5mm Ø
17-459	6mm Ø	17-489	6.5mm Ø
17-460	7mm Ø	17-490	7.5mm Ø
17-461	8mm Ø	17-491	8.5mm Ø
17-462	9mm Ø	17-492	9.5mm Ø
17-463	10mm Ø	17-493	10.5mm Ø
17-464	11mm Ø	17-494	11.5mm Ø
17-465	12mm Ø	17-495	12.5mm Ø
17-466	13mm Ø	17-496	13.5mm Ø
17-467	14mm Ø	17-497	14.5mm Ø
17-468	15mm Ø	17-498	15.5mm Ø
17-469	16mm Ø	17-499	16.5mm Ø
17-470	17mm Ø	17-500	17.5mm Ø
17-471	18mm Ø	17-501	18.5mm Ø
17-472	19mm Ø	17-502	19.5mm Ø
17-473	20mm Ø	17-503	20.5mm Ø
17-474	21mm Ø	17-504	21.5mm Ø
17-475	22mm Ø	17-505	22.5mm Ø
17-476	23mm Ø	17-506	23.5mm Ø
17-477	24mm Ø		
17-478	25mm Ø		
17-479	26mm Ø		
17-480	27mm Ø		
17-481	28mm Ø		
17-482	29mm Ø		
17-483	30mm Ø		



Hagar Uterine Dilator

single ended
17-507 4 mm - 17 mm Ø
8 Pieces per set
17-508 1 mm - 26 mm Ø
24 Pieces per set



Hagar Uterine Dilator

single ended
17-509 4 mm - 17 mm Ø
24 pieces per set

RETRACTORS AND SALPINGOGRAPH

Retraktoren und Salpingograph
Ecarteurs et salpingographie

Retractores y Salpingografía
Diuaricatori e salpingografi



GELPI
Vulva Self Retaining



DOYEN
Vaginal Flat Retractor
17-511
1.75mm x 10mm x 23cm



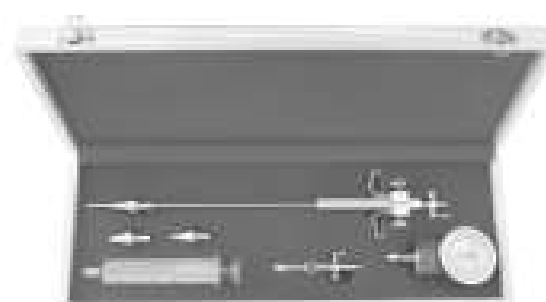
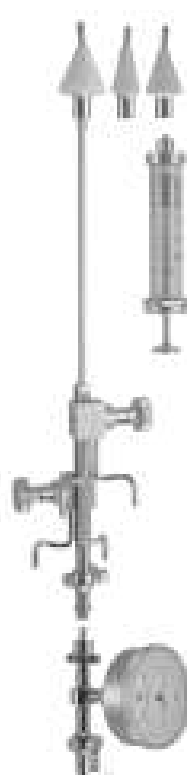
JOLL Thyroid Self Retaining
17-512 15.5cm



Forceps for I.U.D. Removing
17-513
4 mm Ø x=230 mm



17-514
IUP Grasping Forceps 3 mm
22 cm



Schulze, Salpingograph
17-515 29.5 cm
complete in wooden case

Catheres Retraktoren & Verbandzangen

Retractor de cateteres y pinzas de apósito

Ecarteurs et pinces à pansements

Divaricatori Cateteres e pinze per medicazione



5mm

17-516 5mm x 25mm
11.5cm
17-517 5mm x 50mm
14cm
17-518 5mm x 80mm
17cm

Cannula

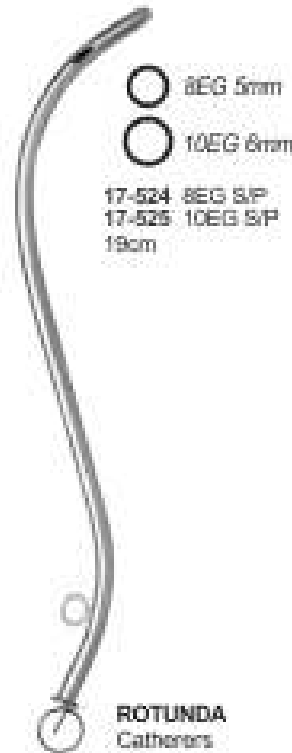
HORMONE
Implant Trocar Set



6EG 4mm
7EG 4.5mm
8EG 5mm
9EG 5.5mm
10EG 6mm

17-519 6EG S/P
17-520 7EG S/P
17-521 8EG S/P
17-522 9EG S/P
17-523 10EG S/P
15.5 cm

FEMALE
Catherers



8EG 5mm
10EG 6mm

17-524 8EG S/P
17-525 10EG S/P
19cm

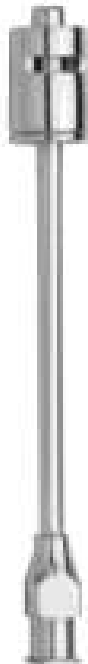
ROTUNDA
Catherers



6EG 4mm
8EG 5mm
10EG 6mm
12EG 7mm

FEMALE
Bladder Sounds
17-526 6EG S/P
17-527 8EG S/P
17-528 10EG S/P
17-529 12EG S/P
24cm

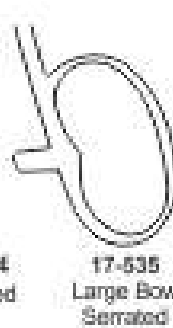
NEEDLE EXTENSIONS



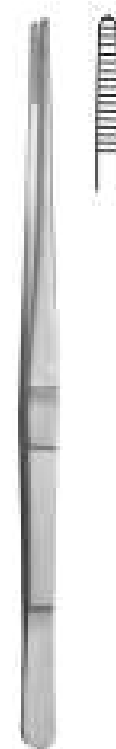
LEUR
Needle Extensions
17-530 7.5cm
17-531 10cm
17-532 13cm



BOZEMAN
Dressing Forceps
27cm
Box Joint



BONNEY
Vaginal Clamps
17-536
34.5cm
Screw Joint



VAGINAL
Dressing Forceps
17-537
24cm
Serrated

UTERINE SOUNDS

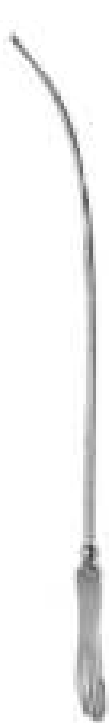


Uterus-Sonden

Histerómetros uterinos

Hystéromètres du col de l'utérus

Isterometri uterini



Sims Uterine Sound
17-538 32 cm
right, graduated in cm
17-539 32 cm
malleable graduated in cm



Sims Uterine Sound
17-540
33 cm
right, malleable



Sims Uterine Sound
17-541
32.5cm
Non-graduated



Sims Uterine Sound
17-542
32.5cm
Graduated in cm



Sims Uterine Sound
17-543
24cm
Graduated in cm



Sims-Special Uterine Sound
17-544
33 cm



Sims Uterine Sound schwed. Model
17-545
28 cm



Martin Uterine Sound
17-546 30 cm



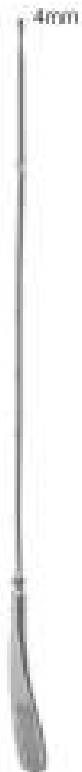
Valleix Uterine Sound
17-547 25 cm



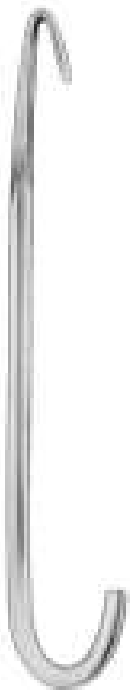
Mayo Uterine Sound
17-548 33 cm
bicuspid malleable



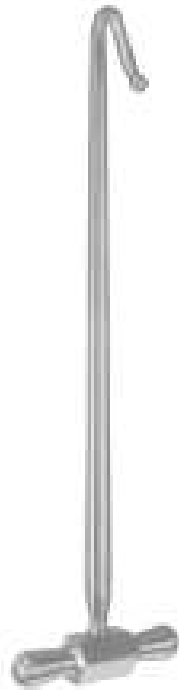
Simpson Uterine Sound
17-549 29 cm
malleable silver-plated



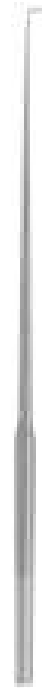
Simpson Uterine Sound
17-550 32.5cm
Graduated in inches



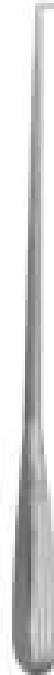
SMELLIE
17-561
30 cm



**Braun, Midwifery
Decapitating hook**
17-562
32.5 cm



**Suture Retrieval
Hook**
17-563
27cm

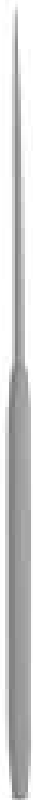


**Suture Retrieval
Hook
Sims Handle**
17-564
27 cm



**IRIS
Skin Hooks**

17-555
18cm
Fine
Colour
Coated



**IRIS
Skin Hooks**

17-556
25.5cm
Fine
Colour
Coated



TENACULUM EMMETT

17-557
23cm
"bic"



TENACULUM 3 PRONG

17-558
26cm
"bic"



WHITTAKER

17-559
18.5cm
"bic"

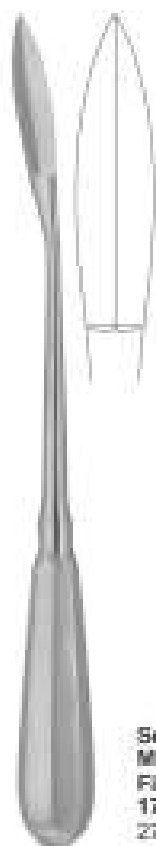
MYOMA INSTRUMENTS, FISTULA HOOKS

Myom-Instrumente, Fistelhaken

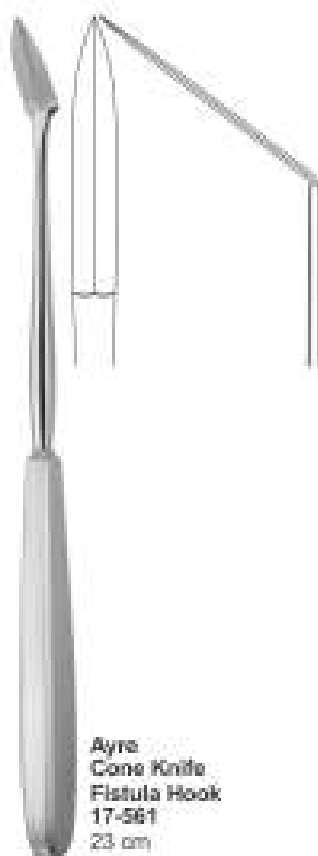
Instrumentos para fibroma, Ganchos para fistulas

Instrumente pour myomes, Crochets pour fistules

Strumenti per miomi, Uncini per fistole



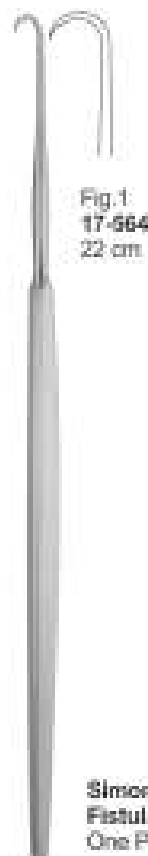
**Segond
Myoma Knife
Fistula Hook**
17-560
27 cm



**Ayre
Cone Knife
Fistula Hook**
17-561
23 cm

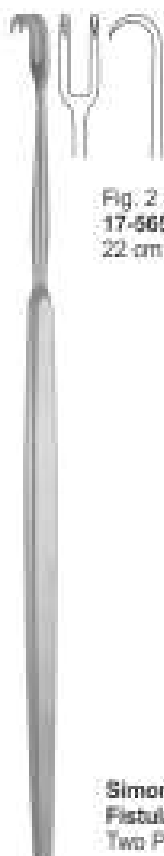


**Doyen
Myoma Screw
And Fistula Hook**
17-562 14.5cm
17-563 17 cm



**Fig. 1
17-564
22 cm**

**Simon
Fistula Hook,
One Prong**



**Fig. 2
17-565
22 cm**

**Simon
Fistula Hook,
Two Prong**



**Emmet
Fistula Hook**



**Fig. 1
17-566
22 cm**



**Fig. 2
17-567
22 cm**



**Fig. 3
17-568
22 cm**



**Fig. 4
17-569
22 cm**



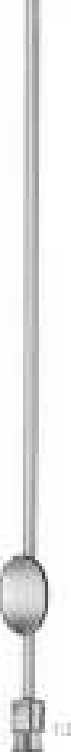
**Fig. 5
17-570
22 cm**

Biopsieküretten, Absaugküretten

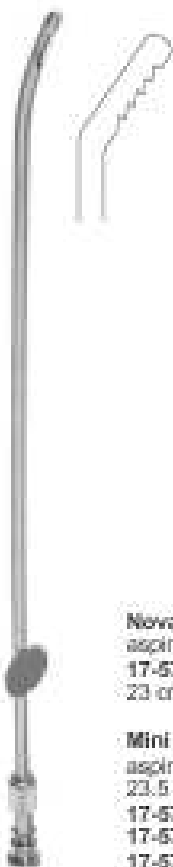
Curetas de aspiración

Curettes pour biopsie, Curettes d'aspiration

Curette per aspirazione

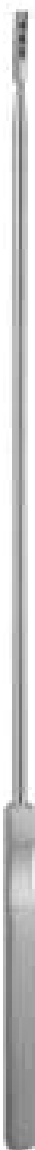


Uni - Randall
aspirating curette
17-571 4 mm Ø
24 cm



Novak
aspirating curette
17-576 4 mm Ø
23 cm

Mint - Novak
aspirating curette
23.5 cm
17-577 1 mm Ø
17-578 2 mm Ø
17-579 3 mm Ø



Uni - Randall
aspirating curette
17-572
30 cm
rigid, without basket

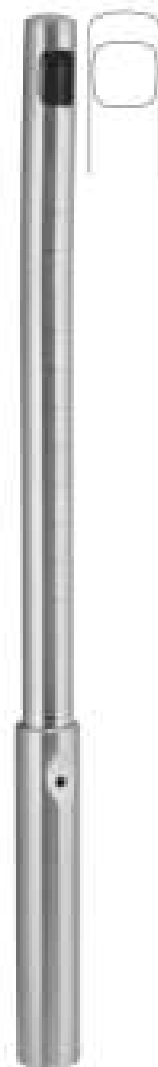
Uni - Randall
aspirating curette
17-573
30 cm
malleable,
without basket



Uni - Randall
aspirating curette
17-574
30 cm
rigid, with basket

Uni - Randall
aspirating curette
17-575
30 cm
malleable,
with basket

**Specimen And
Aspirating Curette**
20 cm
17-580 3 mm Ø
17-581 4 mm Ø
17-582 6 mm Ø
17-583 8 mm Ø
17-584 10 mm Ø
17-585 12 mm Ø
17-586 14 mm Ø

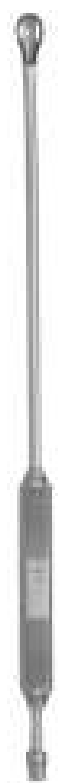
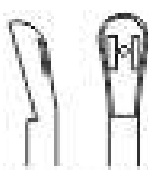


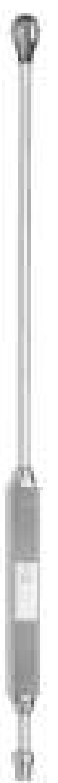
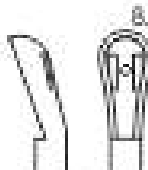

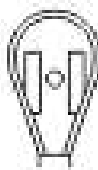







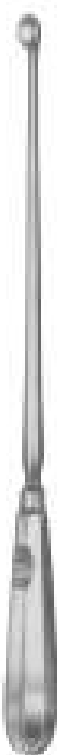

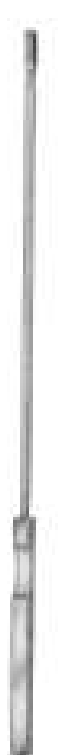


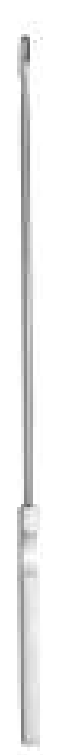
Coupling Piece
aspirating curette
12 cm
17-587



FLUSHING CURETTES

Küretten spülen | Cúretas de lavado
Curettes de rinçage | Cúrette di lavaggio

	 17-588 Small 29cm 8mm Sharp  17-589 Medium 29cm 11mm Sharp  17-590 Large 29cm 14mm Sharp		 8.0mm 17-591 Small 29cm 8mm Blunt  17-592 Medium 29cm 11mm Blunt  17-593 Large 29cm 14mm Blunt	 17-594 12 FG 4mm 25.5cm	 1mm 25.5cm 2mm 25.5cm 3mm 25.5cm 4mm 25.5cm 1 ● 17-595 2 ● 17-596 3 ● 17-597 4 ● 17-598	 2mm 25.5cm 3mm 25.5cm 4mm 25.5cm 2 ● 17-599 3 ● 17-600 4 ● 17-601
<p>Rheinstadter Flushing Curettes</p>	<p>Rheinstadter Flushing Curettes</p>	<p>Rheinstadter Flushing Curettes</p>	<p>Leechwilkinson Suction Biopsy Curettes</p>	<p>Novak Suction Biopsy Curettes</p>	<p>Novak Suction Biopsy Curettes</p>	<p>Randall Suction Biopsy Curettes</p>

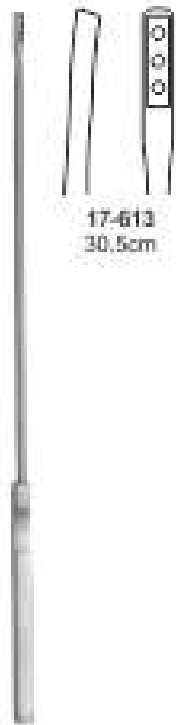
 17-602 10FG 23cm C/P	 10FG 3.3mm	 17-603 17-605 17-607	 17-604 17-606 17-608	 17-609 30 cm 1.2mm	 17-610 30 cm 4.0 mm Without Basket  17-611 30 cm 4.0 mm With Basket	 17-612 30.5cm
<p>Shaman Endometrial Biopsy Curettes</p>	<p>SCHROEDER 30 cm, 12' sharp, rigid</p>	<p>SCHROEDER 30 cm, 12' sharp, rigid</p>	<p>SCHROEDER 30 cm, 12' sharp, rigid</p>	<p>KEVORKIAN</p>	<p>KEVORKIAN</p>	<p>Kevorkian Endocervical Curettes With Basket Round</p>

isöffel, Abaugkünetten, uterusdepressor

Curettes uterines, curettes d'aspiration, Dépresseur utérin

aríllas uterinas, Cúretos aspiradoras, depresor uterino

Curette uterine, curette pe aspirazione, depressore uterino



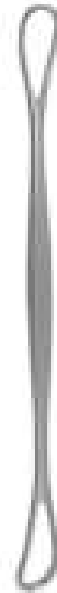
17-613
30.5cm

**Kevorkian
Endocervical
Curettes
With Basket Square**

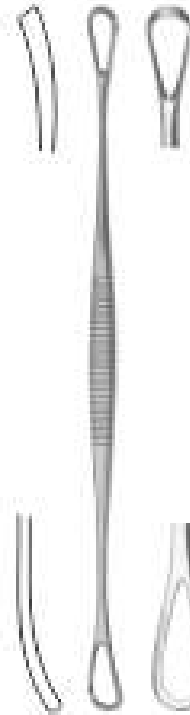


17-614
30.5cm

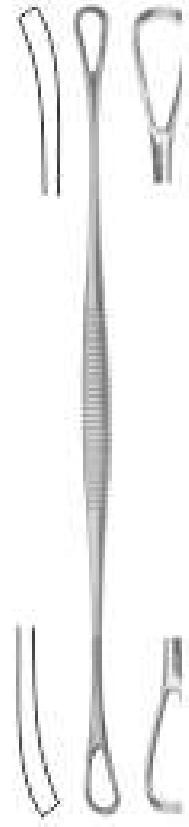
**Kevorkian
Endocervical
Curettes
Without Basket Square**



**Braun Uterine Depressor
17-615 25 cm**



**Blake Double Ended
17-616 24.5 cm
Sharp / Blunt**



**Zweifel Double Ended
17-617 24.5cm
Sharp / Sharp**



**Cookley
17cm**



**17-618
Fig. 1**



**17-619
Fig. 2**



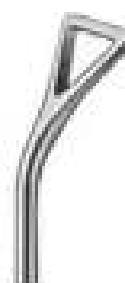
**17-620
Fig. 3**



**17-621
Fig. 4**



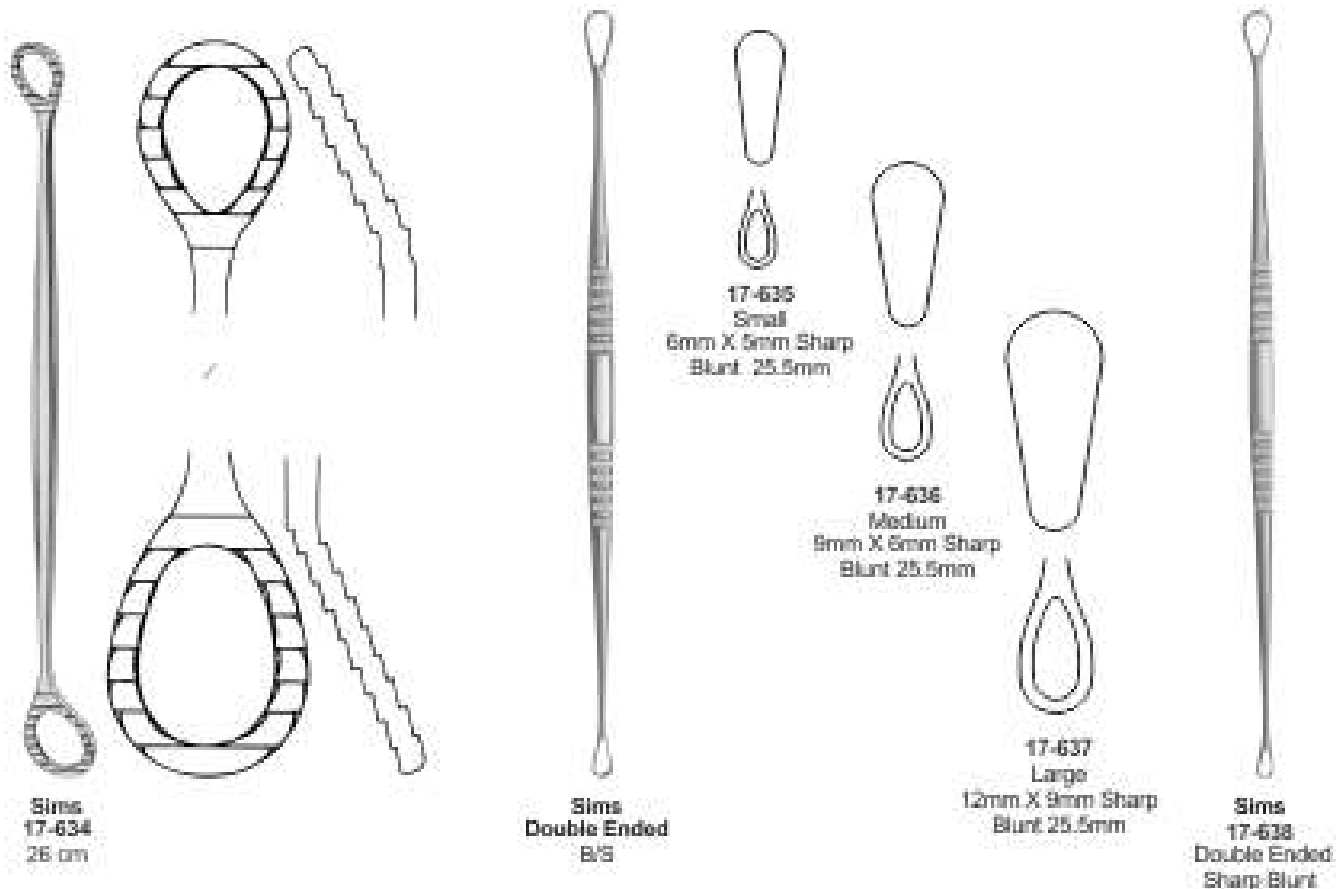
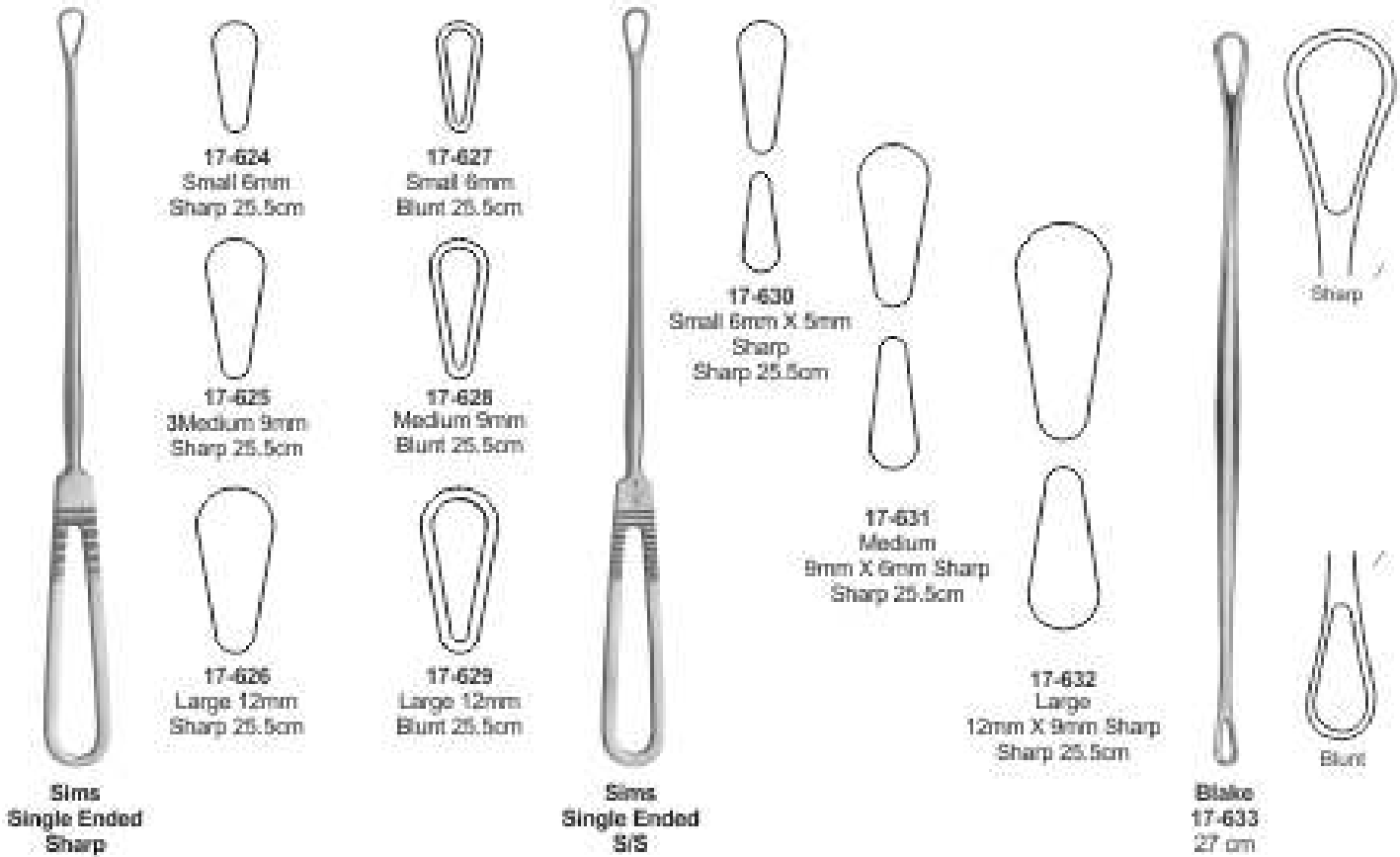
**17-622
Fig. 5**



**17-623
Fig. 6**

UTERINE CURETTES

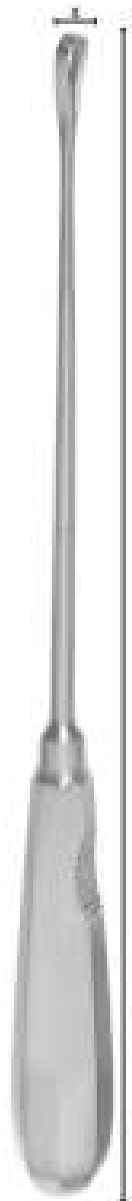
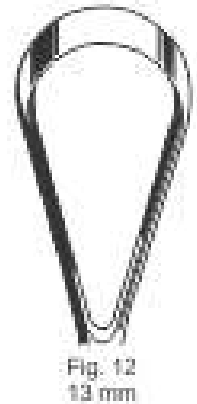
Uterusküretten	Curettes uterinas
Curettes utérines	Curette uterine



UTERINE CURETTES

Uterusküretten | Curettes uterines

Curettes uterines | Curette uterine



Recamier
uterine curette
y=26 cm

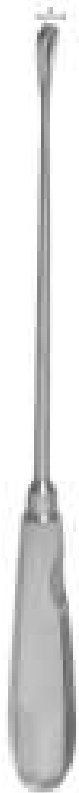
Fig.	x=mm	Sharp, malleable	Blunt, malleable	Sharp, rigid	Blunt, rigid
00	5	17-639	17-653	17-667	17-681
0	6	17-640	17-654	17-668	17-682
1	7	17-641	17-655	17-669	17-683
2	8	17-642	17-656	17-670	17-684
3	9	17-643	17-657	17-671	17-685
4	11	17-644	17-658	17-672	17-686
5	12	17-645	17-659	17-673	17-687
6	14	17-646	17-660	17-674	17-688
7	15	17-647	17-661	17-675	17-689
8	16	17-648	17-662	17-676	17-690
9	19	17-649	17-663	17-677	17-691
10	20	17-650	17-664	17-678	17-692
11	21	17-651	17-665	17-679	17-693
12	23	17-652	17-666	17-680	17-694

Recamier
uterine curette
y=31 cm

Fig.	x=mm	Sharp, malleable	Blunt, malleable	Sharp, rigid	Blunt, rigid
00	5	17-695	17-709	17-723	17-737
0	6	17-696	17-710	17-724	17-738
1	7	17-697	17-711	17-725	17-739
2	8	17-698	17-712	17-726	17-740
3	9	17-699	17-713	17-727	17-741
4	11	17-700	17-714	17-728	17-742
5	12	17-701	17-715	17-729	17-743
6	14	17-702	17-716	17-730	17-744
7	15	17-703	17-717	17-731	17-745
8	16	17-704	17-718	17-732	17-746
9	19	17-705	17-719	17-733	17-747
10	20	17-706	17-720	17-734	17-748
11	21	17-707	17-721	17-735	17-749
12	23	17-708	17-722	17-736	17-750

UTERINE CURETTES

Uterusküretteri | Currettes uterinas
Currettes uterines | Curette uterine



Recamier
Uterine curette
y=34 cm



Fig. 13



Fig. 14



Fig. 15



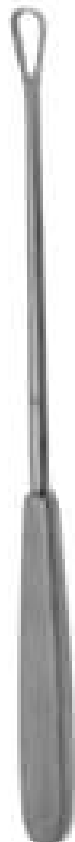
Fig. 16

Fig.	x=mm	Sharp, malleable
13	25	17-751
14	30	17-752
15	35	17-753
16	40	17-754

Blunt, malleable
17-755
17-756
17-757
17-758

Sharp, rigid
17-759
17-760
17-761
17-762

Blunt, rigid
17-763
17-764
17-765
17-766



Sims
uterine curette
28 cm



Fig. 1



Fig. 2



Fig. 3



Fig. 4



Fig. 5



Fig. 6

Fig.	x=mm
1	7
2	8
3	9
4	11
5	12
6	14

Sharp, malleable
17-767
17-768
17-769
17-770
17-771
17-772

Sharp, rigid
17-773
17-774
17-775
17-776
17-777
17-778

Blunt, malleable
17-779
17-780
17-781
17-782
17-783
17-784

Blunt, rigid
17-785
17-786
17-787
17-788
17-789
17-790

UTERINE SPOONS

Scharfe Löffel

Cuchariilas cortantes

Curettes tranchantes

Cucchiai taglianti



Fig. 1
17-791
25 cm
Sharp, rigid

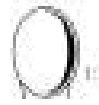


Fig. 2
17-792
25 cm
Sharp, rigid

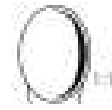


Fig. 3
17-793
25 cm
Sharp, rigid

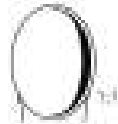


Fig. 4
17-794
25 cm
Sharp, rigid

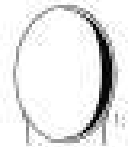


Fig. 5
17-795
25 cm
Sharp, rigid

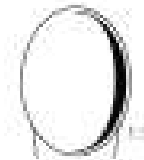


Fig. 6
17-796
25 cm
Sharp, rigid

Schröder
Uterine Spoon

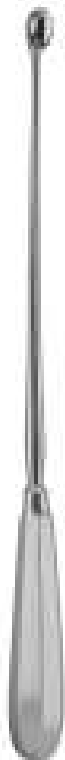


Fig. 1
17-797
30 cm

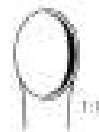


Fig. 2
17-798
30 cm

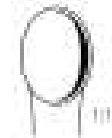


Fig. 3
17-799
30 cm

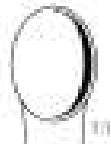


Fig. 4
17-800
30 cm

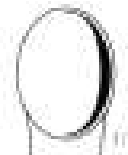


Fig. 5
17-801
30 cm

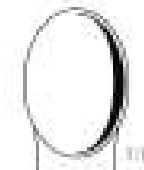
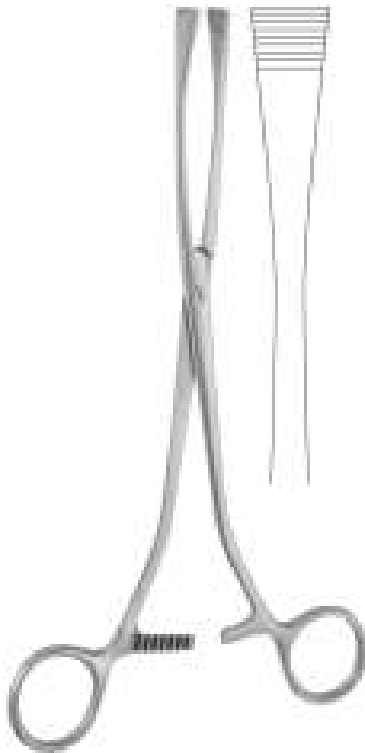


Fig. 6
17-802
30 cm

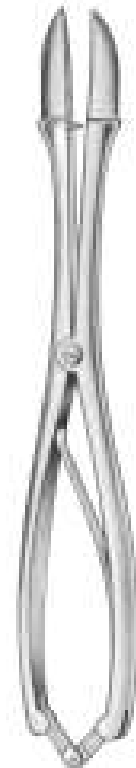
Schröder
Uterine Spoon



Green-Armytage
Uterine Elevating Forceps
17-803 21 cm



Smellie
Obstetrical Forceps
17-804 25 cm
Perforator



NAEGELE
17-805
25 cm



Kane
obstetrical forceps
17-806
8.5 cm



Collin
Obstetrical Forceps
17-807
9 cm



Zimmerman
Myotome,
Spoon Tip,
17-808
24 cm



Zimmerman
Myotome,
Chisel Tip,
17-809
28 cm

szangen - Abortusküretten

Pinzas para abort - Curetas para aborto

à faux germes - Curette d'avortement

Pinze per placenta ed aborto - Curette per placenta ed aborto



Winter
abortion forceps

Fig. 1
17-810
28 cm
straight

17-811
28 cm
curved



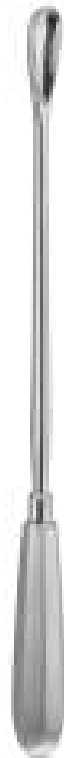
Fig. 2
17-812
28 cm
straight

17-813
28 cm
curved

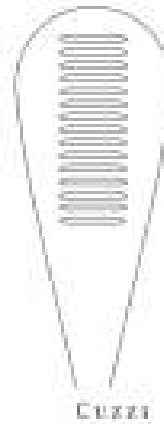


Fig. 3
17-814
28 cm
straight

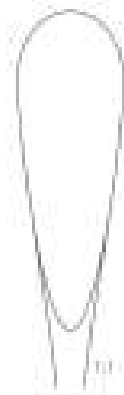
17-815
28 cm
curved



Cuzzi
ovum curette
blunt, back serrated



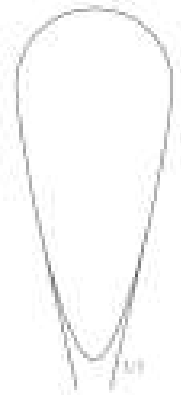
Cuzzi



14.5 mm
17-816
30 cm



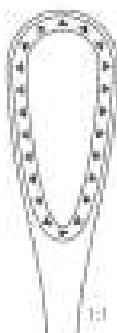
18 mm
17-817
30 cm



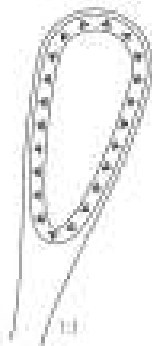
21 mm
17-818
30 cm



Saenger
Abortion Forceps



17-819
27 cm
Straight



17-820
27 cm
Curved



Wallich
ovum curette
17-821 42 cm



Pestalozza
Ovum Curette
17-822 30 cm

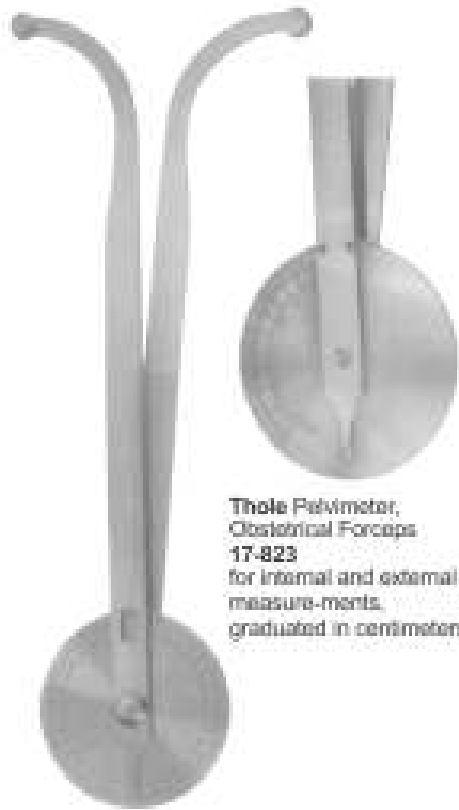
PELVIMETER, OBSTETRICAL FORCEPS

Beckenzirkel, Geburtszangen

Pelvimetro, Forceps obstétricos

Pelvimètre, Forceps obstétriques

Pelvimetri, Forcipi obstetrici



Thole Pelvimeter, Obstetrical Forceps 17-823
for internal and external measurements graduated in centimeters



De Lee Pelvimeter, Obstetrical Forceps 17-824
graduated in centimeters and inches

for internal measurements between symphysis and promontory



Collin Pelvimeter, Obstetrical Forceps 17-825
Graduated in Centimeters



Martin Pelvimeter, Obstetrical Forceps 17-826
graduated in centimeters

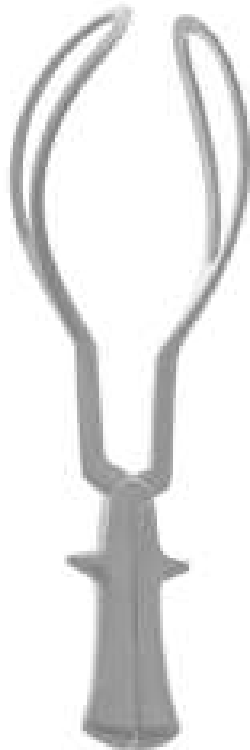


Collin Pelvimeter, Obstetrical Forceps 17-827
graduated in centimeters

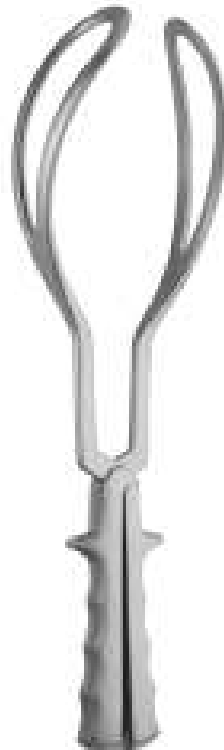
The additional straight arm can be replaced. The pelvimeter with straight arm is used for localisation of the portio vaginalis uteri and of vaginal metastasis.



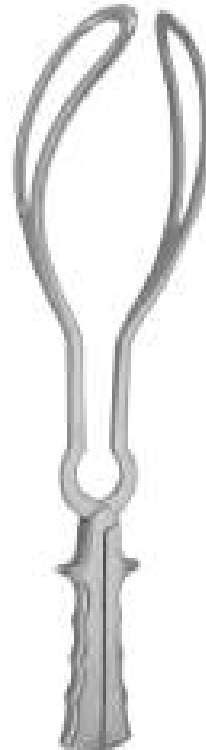
Breisky Pelvimeter, Obstetrical Forceps 17-828
graduated in centimeters



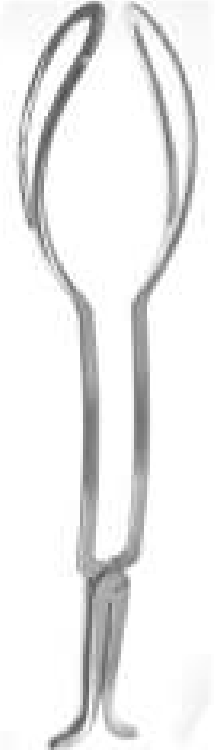
Simpson
Obstetrical Forceps
17-829 23 cm
17-830 30 cm
17-831 33 cm
17-832 36 cm



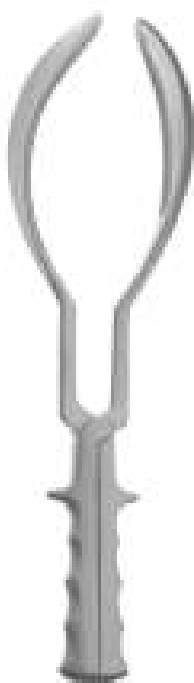
Simpson - Braun
Obstetrical Forceps
17-833 33 cm
17-834 36 cm



Naegeli
Obstetrical Forceps
17-835 36 cm
17-836 40 cm



Piper
obstetrical forceps
17-837 44 cm



Simpson - Luskart
Obstetrical Forceps
17-838 36 cm



Whigley
Obstetrical Forceps
17-839 25 cm
17-840 28 cm
for caesarian section



De Lee
obstetrical forceps
17-841 30 cm



De Lee
obstetrical forceps
17-842 36 cm
17-843 16 cm



Elliot
obstetrical forceps
17-844 32 cm
17-845 35 cm

OBSTETRICAL FORCEPS

Geburtszangen

Forceps obstétricas

Forceps obstétricus

Forcipi



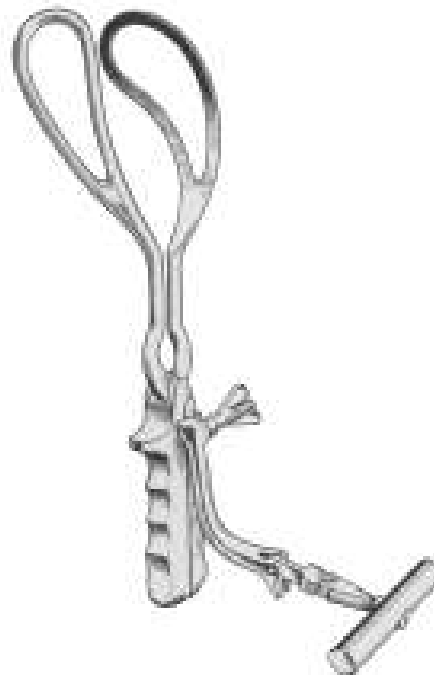
McLean
obstetrical forceps
17-846 36 cm



Kielland
Obstetrical Forceps
17-847 41 cm



Kielland-Luikart
obstetrical forceps
17-848 40 cm



Barnes-Neville
17-849 40 cm
Simpson handles, detachable
axis traction rod and handle.



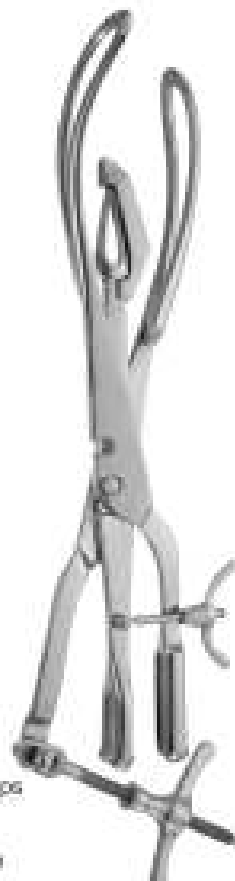
Bil Obstetrical
Holder
17-850



Barnes-Neville
Obstetrical Forceps
17-851
with traction
handle 43.5 cm



Braun
obstetrical forceps
17-852
42 cm
Cranioclast, one
jaw fenestrated

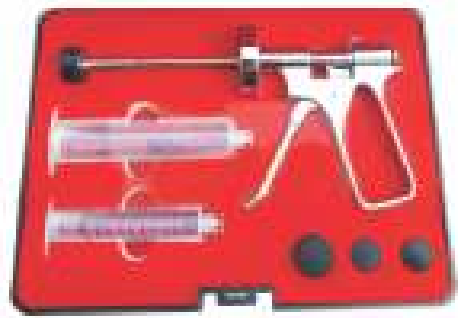


Tarnier
obstetrical forceps
17-853
46 cm
Basiotriba



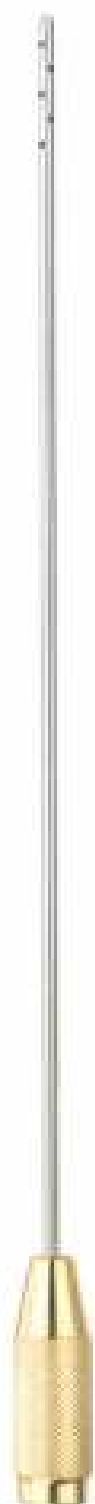
Seilheim
Obstetrical Lever
17-854
28 cm

LIPOSUCTION CANNULAS AND SETS



CANNULAS FOR INILTRATION

Cannulas for Iniltration | Cánulas de iniltración
 Kanülen zur Iniltration | Canules pour l'iniltration



Cannulas For Iniltration
 Measurements = working length



18-001
 2mm Ø
 25cm
 10holes



18-002
 3 mm Ø
 25 cm
 10 holes



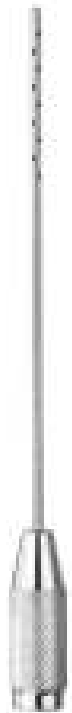
Cannulas
18-003
 9 x 70 mm Ø
18-004
 1 x 120 mm Ø
 . Packing unit 100 pieces, steri



18-005
 Luer-Lock syringes
 Adaptor with Luer-Lock connection, for use of
 cannulas with handle connector on



18-006
 Accessories for Syringes



**Entner
Cannulas**



18-007
2 mm Ø
15 cm
18 holes



18-008
3 mm Ø
15 cm
18 holes



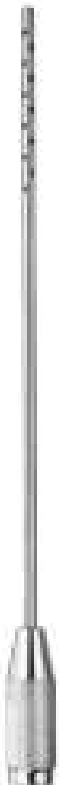
Entner Cannulas
Measurements = working length



18-009
2 mm Ø
15 cm
18 holes



18-010
3 mm Ø
15 cm
18 holes



Entner Cannulas
Measurements = working length



18-011
3 mm Ø
20 cm
22 holes



18-012
4 mm Ø
20 cm
22 holes



**Entner
Cannulas**



18-013
3 mm Ø
20 cm
22 holes

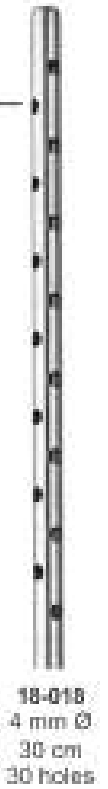
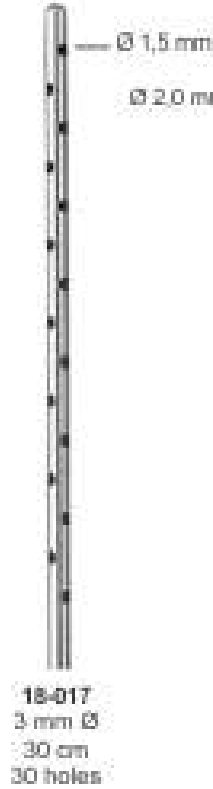
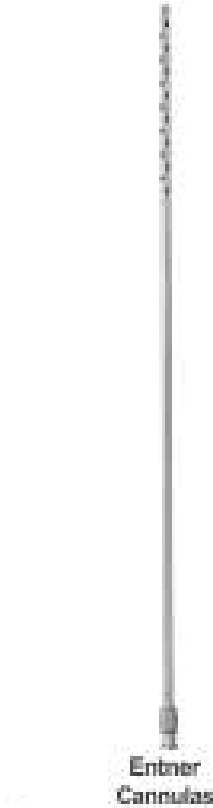
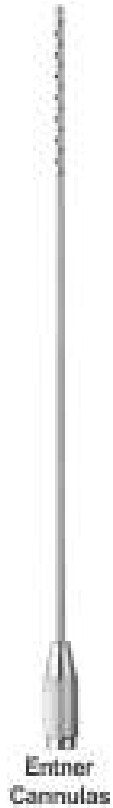


18-014
4 mm Ø
20 cm
22 holes

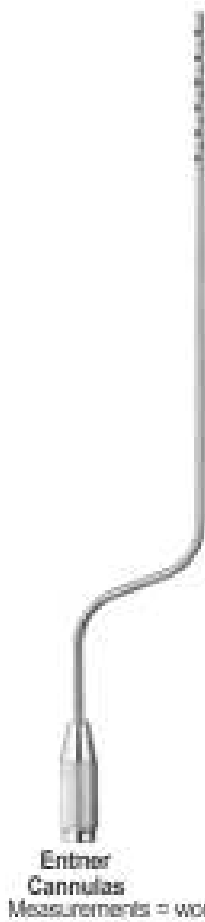
LIPOSUCTION CANNULAS



Liposuction Cannulas | Cánulas de liposucción
 Liposuction-Kanülen | Canules pour liposuction



Measurements = working length



Measurements = working length

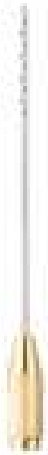
The bayonet shaped handles allow an easier manipulation.



SET SUGGESTIONS LIPOSUCTION CANNULAS

Set Suggestions Liposuction Cannulas
Setvorschlage Liposuction-Kanulen

Proposiciones de juegos canulas de liposucci3n
Propositions pour botes canules pour liposuction



Face Cannulas
18-031
15 cm
2 mm \varnothing



18-032
5 cm 1,7 mm \varnothing
18-033
15 cm 1,7 mm \varnothing



Neck Cannulas
18-034
15 cm
3 mm \varnothing



Neck Cannulas
18-035
20 cm
3 mm \varnothing



Neck Cannulas
18-036
15 cm
2 mm \varnothing



18-037
5 cm 2 mm \varnothing
18-038
5 cm 3 mm \varnothing
18-039
15 cm 2 mm \varnothing
18-040
15 cm 3 mm \varnothing



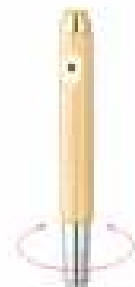
Thigh - Lower Leg Cannulas
18-041 20 cm 3 mm \varnothing
18-042 30 cm 3 mm \varnothing
18-043 20 cm 4 mm \varnothing
18-044 30 cm 4 mm \varnothing



Abdomen / Saddlebag Cannulas
18-045 20 cm 3 mm \varnothing
18-046 20 cm 4 mm \varnothing



Abdomen / Saddlebag Cannulas
18-047 30 cm 3 mm \varnothing
18-048 30 cm 4 mm \varnothing



18-049
with rotatable tube connection
Accessories

Fork shape, rounded tips, dissecting surface between tips / one central hole.



18-050
2 mm Ø
5 cm



18-052
3 mm Ø
5 cm



18-056
4 mm Ø
5 cm



18-059
5 mm Ø
30 cm

18-051
2 mm Ø
15 cm

18-053
3 mm Ø
15 cm

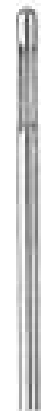
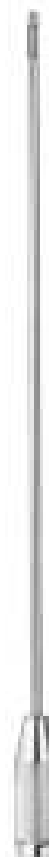
18-057
4 mm Ø
25 cm

18-054
3 mm Ø
25 cm

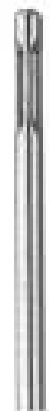
18-058
4 mm Ø
30 cm

18-055
3 mm Ø
30 cm

Toledo Cannulas
Measurements = working length.



18-060
3 mm Ø
15 cm

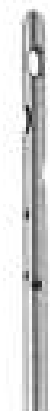


18-062
4 mm Ø
15 cm

18-061
3 mm Ø
25 cm

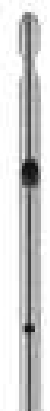
18-063
4 mm Ø
25 cm

three lateral holes



18-054
3 mm Ø
30 cm

Turbo



The improved arrangement of the suction holes ensures a more effective and gentle suction in areas with much connective tissue and in case of gynecomasty.

Mercedes Cannulas
Measurements = working length.

Kotzur Cannulas

LIPOSUCTION CANNULAS



Liposuction Cannulas
Liposuction-Kanülen

Cánulas de liposucción
Canules pour liposuction



Cannulas



one central hole, two lateral holes
Measurements = working length

18-065
3 mm Ø
20 cm

18-066
3 mm Ø
30 cm

18-067
4 mm Ø
30 cm

18-068
5 mm Ø
30 cm

18-069
6 mm Ø
30 cm



Cannulas

Measurements = working length



two lateral holes,
one central hole

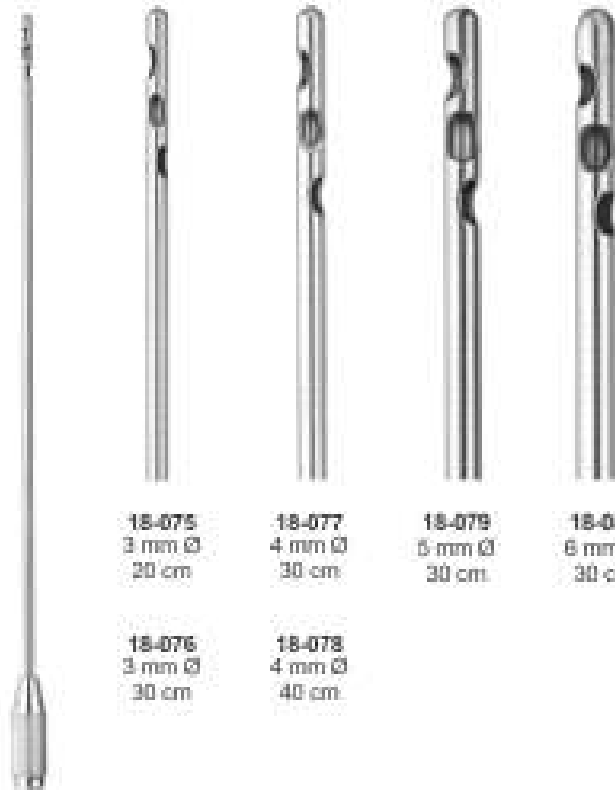
18-070
3 mm Ø
20 cm

18-071
3 mm Ø
30 cm

18-072
4 mm Ø
30 cm

18-073
5 mm Ø
30 cm

18-074
6 mm Ø
30 cm



18-075
3 mm Ø
20 cm

18-077
4 mm Ø
30 cm

18-079
5 mm Ø
30 cm

18-080
6 mm Ø
30 cm

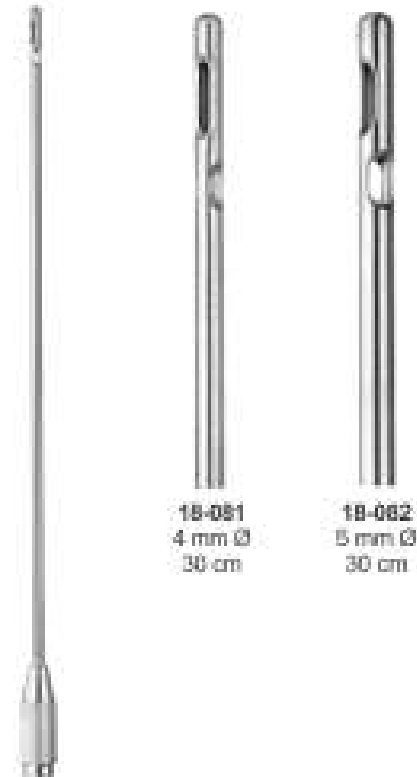
18-076
3 mm Ø
30 cm

18-078
4 mm Ø
40 cm

Cannulas

three holes, diagonal

Measurements = working length



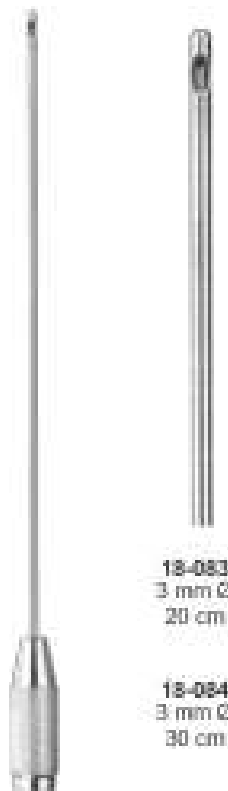
18-081
4 mm Ø
30 cm

18-082
5 mm Ø
30 cm

Cannulas

one central hole, two lateral holes

Measurements = working length

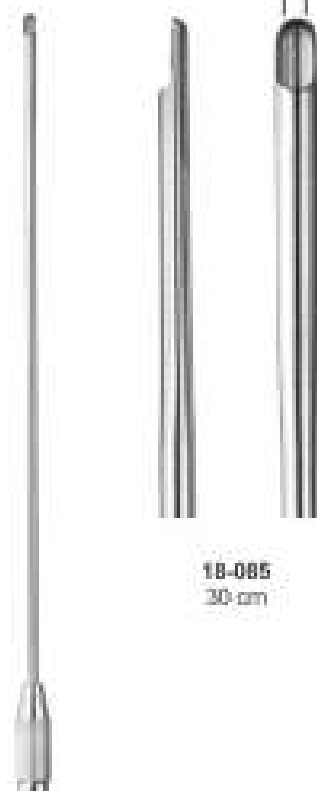


18-083
3 mm Ø
20 cm

18-084
3 mm Ø
30 cm

Cannulas

Point with hole, one lateral hole



18-085
30 cm

6 mm

Cannulas

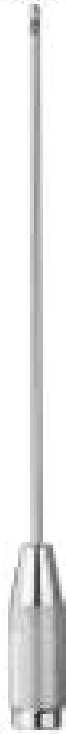
Measurements = working length

LIPOSUCTION CANNULAS



Liposuction Cannulas | Cánulas de liposucción
Liposuction-Kanülen | Canules pour liposuction

For facial contouring
one lateral hole



Cannulas
with handle connector



18-086
1,7 mm Ø
5 cm

18-087
1,7 mm Ø
15 cm



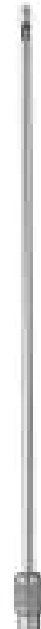
18-088
2 mm Ø
5 cm

18-089
2 mm Ø
15 cm



18-090
3 mm Ø
5 cm

18-091
3 mm Ø
15 cm



18-092
1,7 mm Ø
5 cm

18-093
1,7 mm Ø
15 cm

18-094
2 mm Ø
5 cm

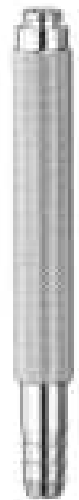
18-095
2 mm Ø
15 cm

18-096
3 mm Ø
5 cm

18-097
3 mm Ø
15 cm

Cannulas
with Luer-Lock connection
Measurements = working length

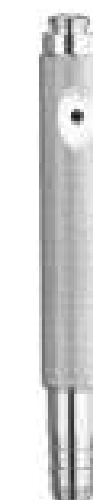
Handles with connection thread for cannulas and hose connection Ø 13 mm, for operation with a suction pump.



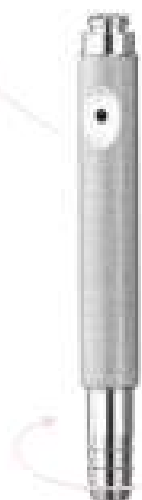
18-098
Fix Handle



18-099
with rotatable tube connection
Handle



18-100
Fix Handle

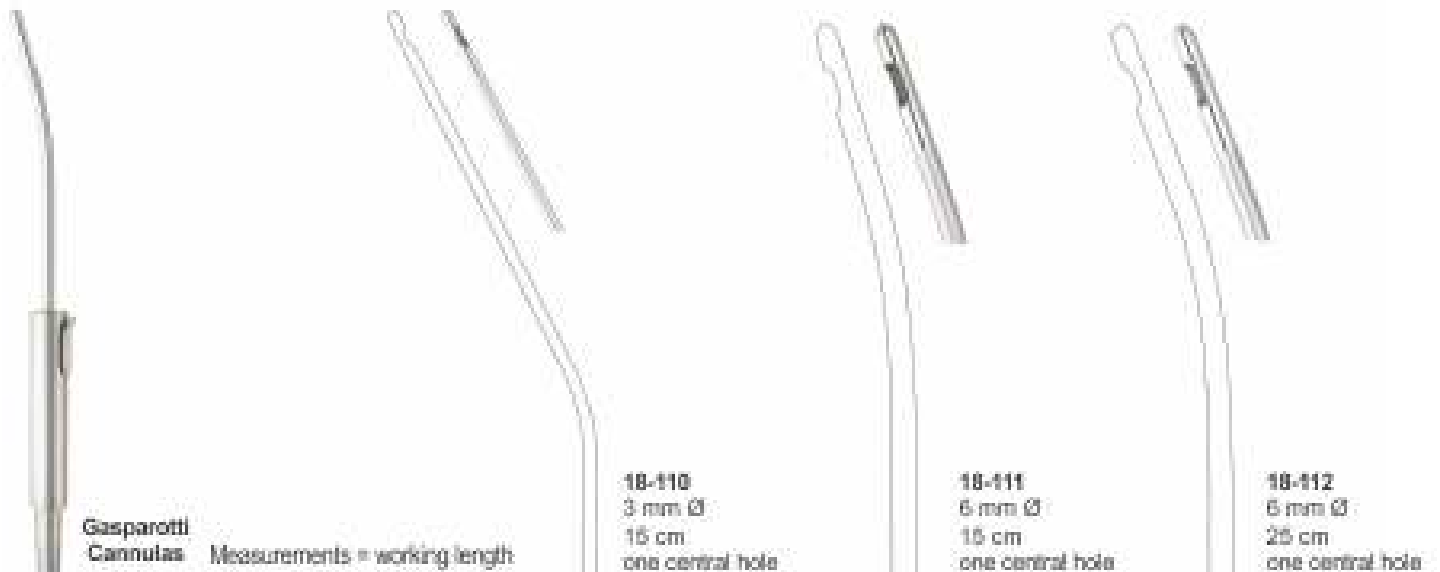
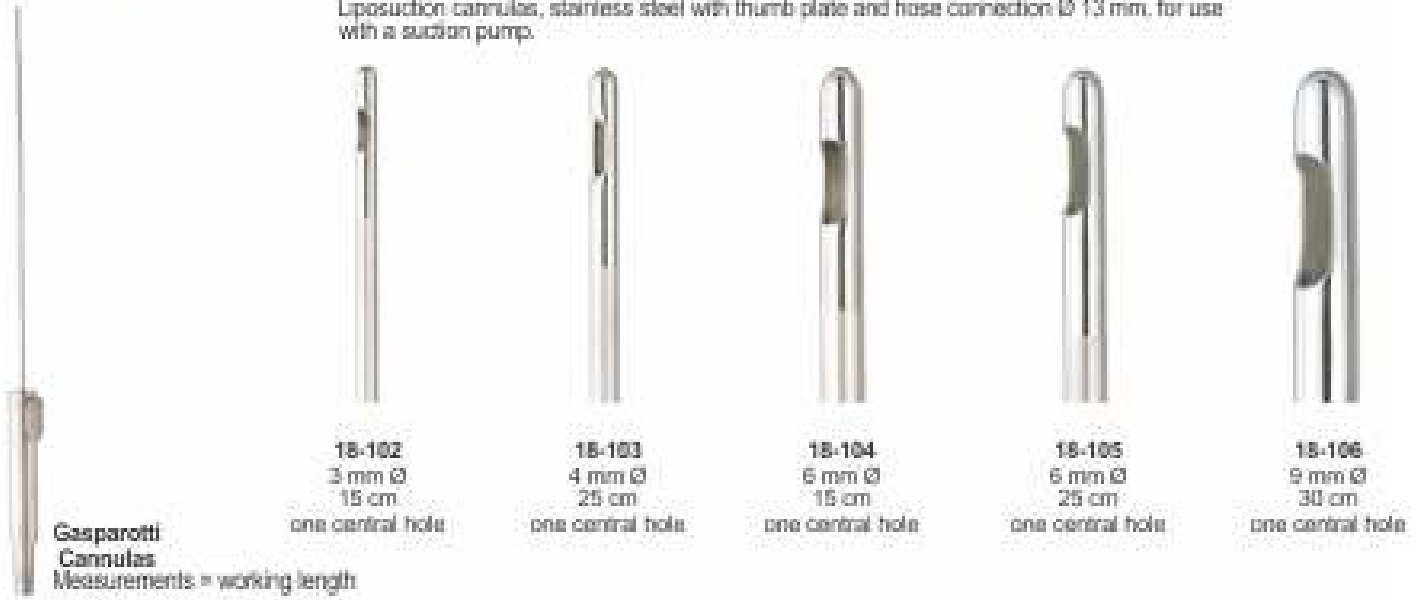


18-101
with rotatable tube connection
Handle

Recommended handles for the tumescence local anaesthesia technique
Hole for interrupting the suction process



Liposuction cannulas, stainless steel with thumb plate and hose connection Ø 13 mm, for use with a suction pump.



Liposuction Cannulas	Cánulas de liposucción
Liposuction-Kanülen	Canules pour liposuction

Liposuction Cannulas Set



18-113
 Liposuction Cannula Set for Abdomen and Saddlebag With Threaded Fitting
 Liposuction Cannula with threaded connector, 22-Holes, diameter 3.0 mm, working length 20cm
 Liposuction Cannula with threaded connector, 22-Holes, diameter 4.0 mm, working length 20cm
 Liposuction Cannula with threaded connector, 30-Holes, diameter 3.0 mm, working length 30cm
 Liposuction Cannula with threaded connector, 30-Holes, diameter 4.0 mm, working length 30cm
 Liposuction Cannula Handle
 Liposuction Cannula Handle with Interrupting Hole



18-114
 Liposuction Cannula Set for Face with Luer Lock Fitting
 Liposuction Cannula, with one central hole, diameter 1.7 mm, working length 5 cm
 Liposuction Cannula, with one central hole, diameter 1.7 mm, working length 15 cm
 Liposuction Cannula, 18-Holes, diameter 2.0 mm, working length 15 cm

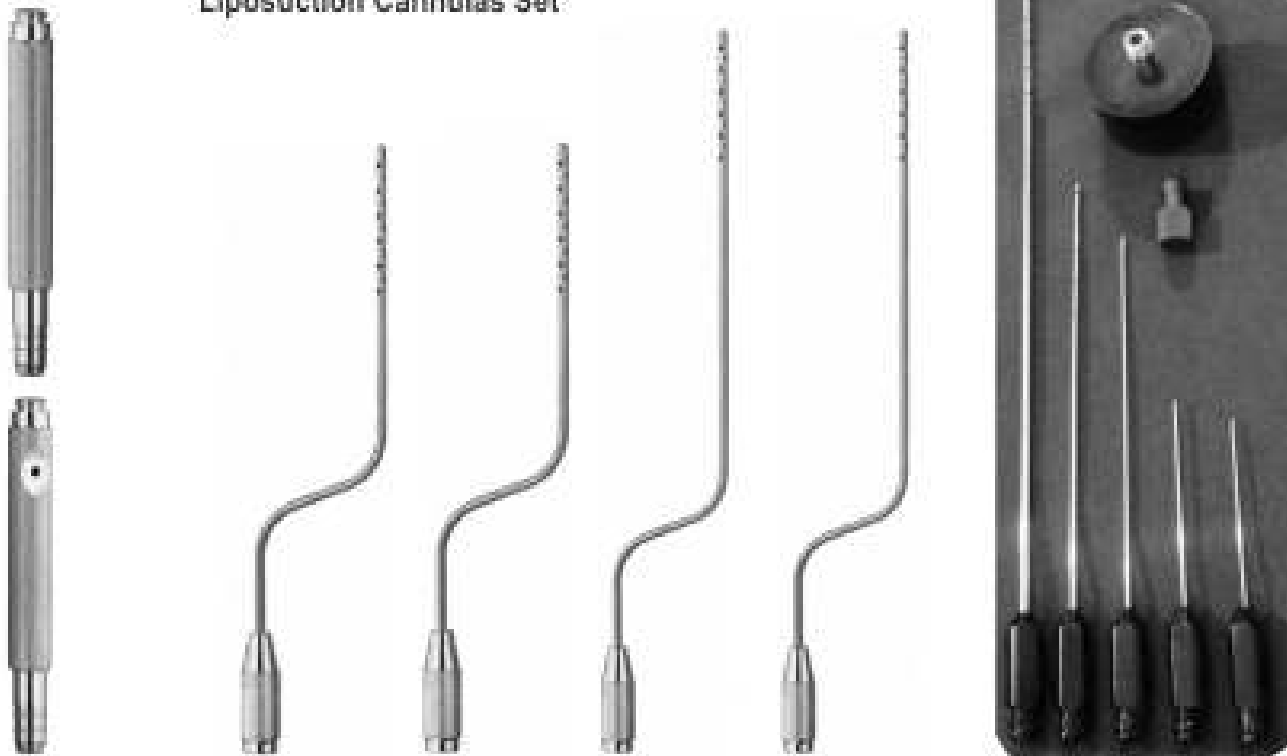


18-115
 Liposuction Cannula Set for Face with Threaded Fitting
 Liposuction Cannula, with one central hole, diameter 1.7 mm, working length 5 cm
 Liposuction Cannula, with one central hole, diameter 1.7 mm, working length 15 cm
 Liposuction Cannula, 18-Holes, diameter 2.0 mm, working length 15 cm
 Liposuction Cannula Handle
 Liposuction Cannula Handle with Interrupting Hole



18-116
 Liposuction Cannula Set for Neck
 Liposuction Cannula with Luer-Lock, with one central hole, diameter 2.0 mm, working length 5cm
 Liposuction Cannula with Luer-Lock, with one central hole, diameter 3.0 mm, working length 5cm
 Liposuction Cannula with Luer-Lock, with one central hole, diameter 3.0 mm, working length 15cm
 Liposuction Cannula with threaded connector, 14-Holes, diameter 3.0 mm, working length 15 cm
 Liposuction Cannula with threaded connector, Angled, 22-Holes, diameter 3.0 mm, working length 20 cm
 Liposuction Cannula with threaded connector, 8-Holes, diameter 2.0 mm, working length 15 cm
 Liposuction Cannula Handle
 Liposuction Cannula Handle with Interrupting Hole

Liposuction Cannulas Set



18-117

Liposuction Cannula Set for Thigh and Lower Leg with Threaded Fitting
 Liposuction Cannula with threaded connector, byonet shape, 23-Holes, diameter 3.0 mm, working length 20 cm
 Liposuction Cannula with threaded connector, byonet shape, 23-Holes, diameter 4.0 mm, working length 20 cm
 Liposuction Cannula with threaded connector, byonet shape, 30-Holes, diameter 3.0 mm, working length 30 cm
 Liposuction Cannula with threaded connector, byonet shape, 30-Holes, diameter 4.0 mm, working length 30 cm
 Liposuction Cannula Handle
 Liposuction Cannula Handle with Interrupting Hole

18-118

Micro Fat Injection Cannulas Set
 Open Port Injector Cannula, 1.2mm, 10cm, Luer Lock
 Multi Holes Harvester Cannula Model 2, 2.5mm, 20cm, Luer Lock
 Tumescent Infiltrator Cannula, 1.5mm, 12cm, Luer Lock
 Micro Injector Cannula, 0.8mm, 4cm, Luer Lock
 Micro Injector Cannula, 1.0mm, 5cm, Luer Lock
 Holding Device
 Luer-Lock Syringe Cap

Safe Cannula Set

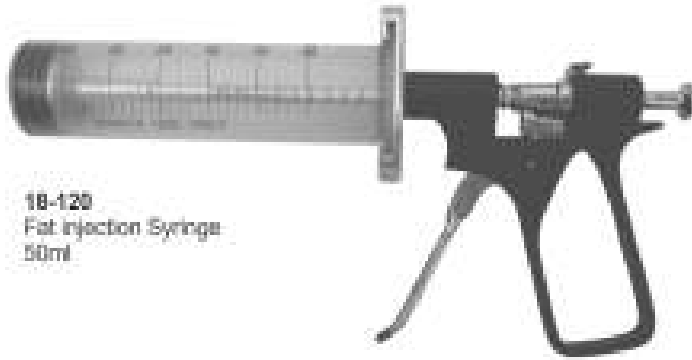
18-119

1 TWO STANDARD HOLE LIPOSUCTION CANNULA, 3.5mm, 25cm, Super Handle
 2 Mercedes Liposuction Cannula, 5.0mm, 30cm, Super Handle
 3 Mercedes Liposuction Cannula, 4.5mm, 30cm, Super Handle
 4 Mercedes Liposuction Cannula, 4.0mm, 25cm, Super Handle
 5 Single Basket Liposuction Cannulas, 4.0mm, 30cm, Super Handle
 6 Double Basket Liposuction Cannulas, 4.0mm, 30cm, Super Handle
 7 Triple Basket Liposuction Cannulas, 4.0mm, 30cm, Super Handle
 8 Spiral Three Port Harvester Cannula, 3.0mm, 20cm, Super Handle
 9 Spiral Three Port Harvester Cannula, 4.0mm, 25cm, Super Handle
 10 Three-Port Harvester Cannula, Model 4, 4.5mm, 30cm, Super Handle
 11 Three Ports Pyramid Cannula, 3.5mm, 25cm, Super Handle
 12 Basket Cannula, 5.0mm, 32cm, Super Handle

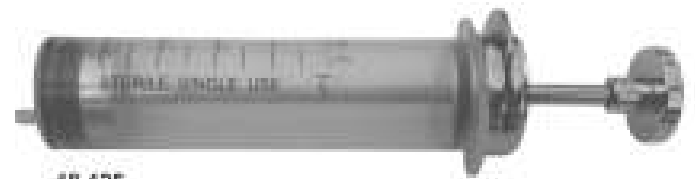


Fat Injection Syringes

Fat Suction Syringes



18-120
Fat Injection Syringe
50ml



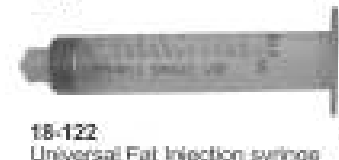
18-125
Fat Suction Syringe
50 ml



18-121
Universal Fat Injection syringe
20ml



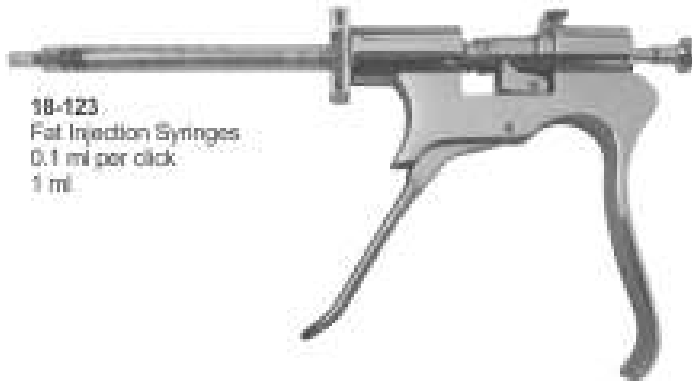
18-126
Fat Suction Syringe
50 ml



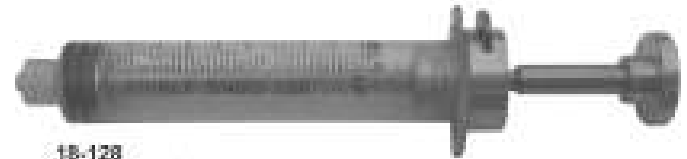
18-122
Universal Fat Injection syringe
10ml



18-127
Fat Suction Syringe
20 ml



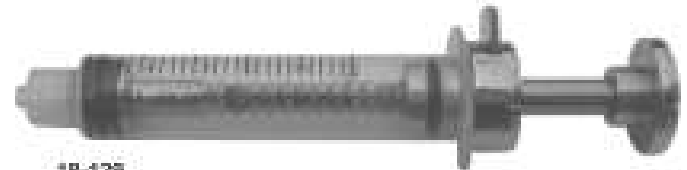
18-123
Fat Injection Syringes
0.1 ml per click
1 ml



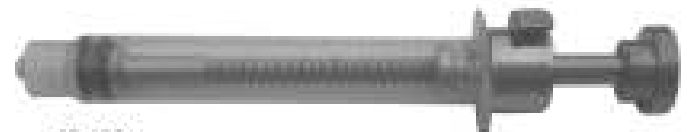
18-128
Fat Suction Syringe
10 ml



18-124
Fat Injection Syringe
3 ml special
0.1 ml per click

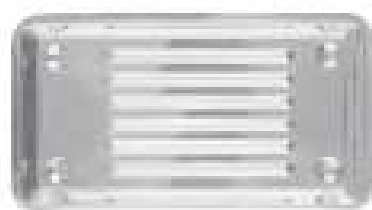


18-129
Fat Suction Syringe
5 ml



18-130
Fat Suction Syringe
3 ml

HOLLOW WARES



STERILIZING DRUMS

Sterilisieren Schlagzeug

Tambours de stérilisation

Tambores de esterilización

Tamburi di sterilizzazione



STERILIZING DRUMS

	Ø	h
	mm	mm
19-001	80	80 mm
19-002	120	120 mm
19-003	160	120 mm
19-004	190	140 mm
19-005	190	200 mm
19-006	240	120 mm
19-007	240	160 mm
19-008	240	240 mm
19-009	290	120 mm
19-010	290	160 mm
19-011	290	240 mm
19-012	340	160 mm
19-013	340	240 mm
19-014	390	145 mm
19-015	360	200 mm
19-016	390	290 mm



STERILIZING DRUM

	Ø	h
	mm	Size mm
19-017	150	150 mm
19-018	175	175 mm
19-019	190	190 mm
19-020	200	140 mm
19-021	200	200 mm
19-022	240	120 mm
19-023	225	225 mm
19-024	240	240 mm
19-025	290	160 mm
19-026	280	240 mm
19-027	230	150 mm
19-028	300	250 mm
19-029	340	250 mm
19-030	360	250 mm
19-031	360	200 mm

STERILIZING DRUM

	Ø	h
	mm	Size mm
19-032	150	150 mm
19-033	175	175 mm
19-034	190	190 mm
19-035	200	140 mm
19-036	200	200 mm
19-037	240	120 mm
19-038	225	225 mm
19-039	240	240 mm
19-040	290	160 mm
19-041	280	240 mm
19-042	230	150 mm
19-043	300	250 mm
19-044	340	250 mm
19-045	360	250 mm
19-046	360	200 mm

STERILIZING DRUM

	Ø	h
	mm	Size mm
19-047	150	150 mm
19-048	175	175 mm
19-049	190	190 mm
19-050	200	140 mm
19-051	200	200 mm
19-052	240	120 mm
19-053	225	225 mm
19-054	240	240 mm
19-055	290	160 mm
19-056	280	240 mm
19-057	230	150 mm
19-058	300	250 mm
19-059	340	250 mm
19-060	360	250 mm
19-061	360	200 mm

STERILIZING DRUM

	Ø	h
	mm	Size mm
19-062	150	150 mm
19-063	175	175 mm
19-064	190	190 mm
19-065	200	140 mm
19-066	200	200 mm
19-067	240	120 mm
19-068	225	225 mm
19-069	240	240 mm
19-070	290	160 mm
19-071	280	240 mm
19-072	230	150 mm
19-073	300	250 mm
19-074	340	250 mm
19-075	360	250 mm
19-076	360	200 mm



G LOVES BOX
19-077
300 x 150 mm



INSTRUMENT TRAY WITH COVER
19-078

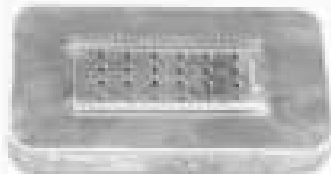


INSTRUMENT TRAY
19-079



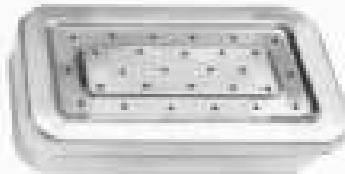
CATHER TRAY

	Size
19-080	230 x 75 mm
19-081	350 x 90 mm
19-082	430 x 100 mm
19-083	200 x 100 mm
19-084	300 x 100 mm
19-085	350 x 100 mm



PERFORATED BOX

	Size
19-086	100 x 50 mm
19-087	165 x 65 mm
19-088	250 x 100 mm
19-089	250 x 150 mm
19-090	250 x 200 mm
19-091	150 x 65 mm
19-092	170 x 70 mm
19-093	200 x 100 mm
19-094	250 x 125 mm
19-095	300 x 150 mm
19-096	300 x 200 mm
19-097	300 x 130 mm
19-098	320 x 150 mm
19-099	420 x 180 mm
19-100	460 x 125 mm
19-101	355 x 180 mm
19-102	300 x 180 mm
19-103	400 x 200 mm
19-104	510 x 200 mm



BOX WITH FILTER

	Size
19-105	100 x 50 mm
19-106	165 x 65 mm
19-107	250 x 100 mm
19-108	250 x 150 mm
19-109	250 x 200 mm
19-110	150 x 65 mm
19-111	170 x 70 mm
19-112	200 x 100 mm
19-113	250 x 125 mm
19-114	300 x 150 mm
19-115	300 x 200 mm
19-116	300 x 130 mm
19-117	320 x 150 mm
19-118	420 x 180 mm
19-119	460 x 125 mm
19-120	355 x 180 mm
19-121	300 x 180 mm
19-122	400 x 200 mm
19-123	510 x 200 mm



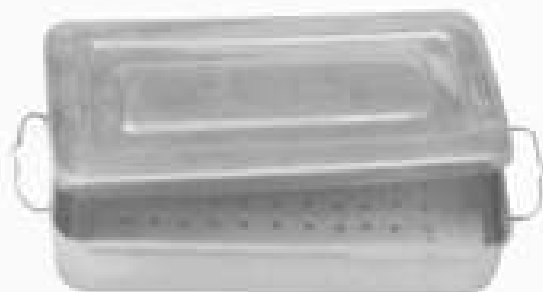
INSTRUMENTS BOX

Without Clip	Size
19-124	100 x 50 mm
19-125	165 x 65 mm
19-126	250 x 100 mm
19-127	250 x 150 mm
19-128	250 x 200 mm
19-129	150 x 65 mm
19-130	170 x 70 mm
19-131	200 x 100 mm
19-132	250 x 125 mm
19-133	300 x 150 mm
19-134	300 x 200 mm
19-135	300 x 130 mm
19-136	320 x 150 mm
19-137	420 x 180 mm
19-138	460 x 125 mm
19-139	355 x 180 mm
19-140	300 x 180 mm
19-141	400 x 200 mm
19-142	510 x 200 mm



INSTRUMENT BOX

With Clip	Size
19-143	100 x 50 mm
19-144	165 x 65 mm
19-145	250 x 100 mm
19-146	250 x 150 mm
19-147	250 x 200 mm
19-148	150 x 65 mm
19-149	170 x 70 mm
19-150	200 x 100 mm
19-151	250 x 125 mm
19-152	300 x 150 mm
19-153	300 x 200 mm
19-154	300 x 130 mm
19-155	320 x 150 mm
19-156	420 x 180 mm
19-157	460 x 125 mm
19-158	355 x 180 mm
19-159	300 x 180 mm
19-160	400 x 200 mm
19-161	510 x 200 mm



INSTRUMENT BOILER

	Size
19-162	180 x 80 x 40 mm
19-163	200 x 100 x 50 mm
19-164	250 x 125 x 40 mm
19-165	300 x 150 x 60 mm
19-166	350 x 175 x 75 mm
19-167	400 x 200 x 100 mm



PERFORATED TRAY

	Size
19-168	180 x 80 x 40 mm
19-169	200 x 100 x 50 mm
19-170	250 x 125 x 40 mm
19-171	300 x 150 x 60 mm
19-172	350 x 175 x 75 mm
19-173	400 x 200 x 100 mm



INSTRUMENT BOILER ELECTRIC

Size

19-174	180 x 80 x 40 mm
19-175	200 x 100 x 50 mm
19-176	250 x 125 x 40 mm
19-177	300 x 150 x 60 mm
19-178	350 x 175 x 75 mm
19-179	400 x 200 x 100 mm



INSTRUMENT BOILER WITH STAND

Size

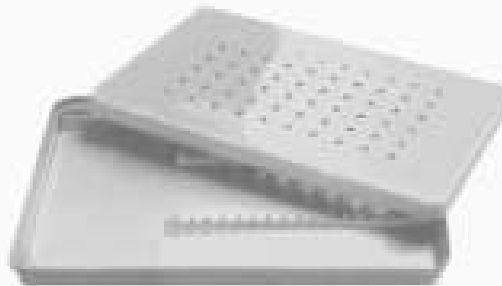
19-180	180 x 80 x 40 mm
19-181	200 x 100 x 50 mm
19-182	250 x 125 x 40 mm
19-183	300 x 150 x 60 mm
19-184	350 x 175 x 75 mm
19-185	400 x 200 x 100 mm



NEEDLE CASE

19-186

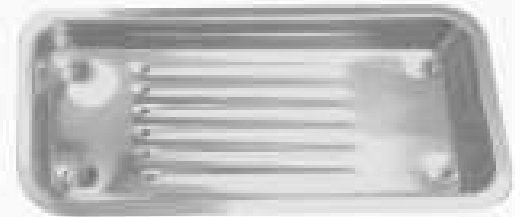
230 x 125 mm



SCALER BOX

19-187

300 x 180 mm



SCALER TRAY

19-188

100 x 200 mm



INDO BOX WITH SILVER FRAME

19-189



Autoclaveable
19-190



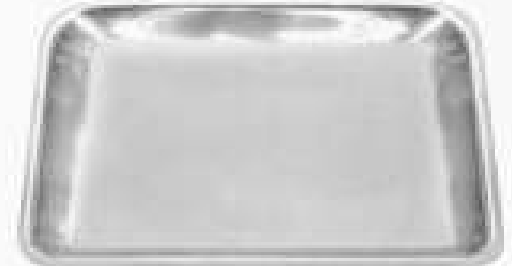
INSTRUMENT TRAY WITHOUT COVER

Size

19-191	240 x 240 mm
19-192	355 x 400 mm
19-193	300 x 150 mm
19-194	300 x 180 mm
19-195	300 x 240 mm
19-196	340 x 320 mm
19-197	230 x 180 mm
19-198	250 x 130 mm
19-199	200 x 130 mm
19-200	180 x 130 mm
19-201	150 x 100 mm

Size

19-202	230 x 125 mm
19-203	200 x 150 mm
19-204	250 x 200 mm
19-205	300 x 250 mm
19-206	350 x 300 mm
19-207	400 x 350 mm
19-208	450 x 300 mm
19-209	300 x 200 mm
19-210	350 x 250 mm
19-211	250 x 125 mm
19-212	200 x 100 mm
19-213	400 x 200 mm



INSTRUMENT TRAY WITHOUT COVER

Size

19-214	240 x 240 mm
19-215	355 x 400 mm
19-216	300 x 150 mm
19-217	300 x 180 mm
19-218	300 x 240 mm
19-219	340 x 320 mm
19-220	230 x 180 mm
19-221	250 x 130 mm
19-222	200 x 130 mm
19-223	180 x 130 mm
19-224	150 x 100 mm

Size

19-225	230 x 125 mm
19-226	200 x 150 mm
19-227	250 x 200 mm
19-228	300 x 250 mm
19-229	350 x 300 mm
19-230	400 x 350 mm
19-231	450 x 300 mm
19-232	300 x 200 mm
19-233	350 x 250 mm
19-234	250 x 125 mm
19-235	200 x 100 mm
19-236	400 x 200 mm



KIDNEY TRAY WITH COVER
(English Pattern)

	Size
19-237	150 mm
19-238	200 mm
19-239	240 mm
19-240	300 mm



KIDNEY TRAY (German Pattern)
(without cover)

	Size
19-241	150 mm
19-242	200 mm
19-243	240 mm
19-244	300 mm



SPLIT LAMP
19-245
100 ml.



BOWL

	Size
19-246	80 mm
19-247	100 mm
19-248	125 mm
19-249	150 mm
19-250	200 mm
19-251	250 mm
19-252	300 mm
19-253	350 mm
19-254	400 mm



WASH BASIN

	Size
19-255	80 mm
19-256	100 mm
19-257	125 mm
19-258	150 mm
19-259	200 mm
19-260	250 mm
19-261	300 mm
19-262	350 mm
19-263	400 mm



BOWL

	Size
19-264	80 mm
19-265	100 mm
19-266	125 mm
19-267	150 mm
19-268	200 mm
19-269	250 mm
19-270	300 mm
19-271	350 mm
19-272	400 mm



DRESSING JAR WITH KNOB

	Size
19-273	80 x 80 mm
19-274	100 x 100 mm
19-275	125 x 125 mm
19-276	150 x 150 mm
19-277	200 x 200 mm



DRESSING JAR

	Size
19-278	80 x 80 mm
19-279	100 x 100 mm
19-280	125 x 125 mm
19-281	150 x 150 mm
19-282	200 x 200 mm



DRESSING JAR

	Size
19-283	80 x 80 mm
19-284	100 x 100 mm
19-285	125 x 125 mm
19-286	150 x 150 mm
19-287	200 x 200 mm



DRESSING JAR

	Size
19-288	80 x 80 mm
19-289	100 x 100 mm
19-290	125 x 125 mm
19-291	150 x 150 mm
19-292	200 x 200 mm

HOLLOWARE INSTRUMENTS



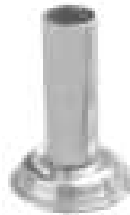
Holloware Instrumenten
Orfebreria Instrumentos

orfènerie de Instruments de
Holloware Gli strumenti



**FORCEPS
JAR**

	Size
19-293	55 x 100 mm
19-294	55 x 140 mm
19-295	55 x 170 mm
19-296	55 x 180 mm
19-297	80 x 100 mm



**FORCEPS
JAR**

	Size
19-298	55 x 100 mm
19-299	55 x 140 mm
19-300	55 x 170 mm
19-301	55 x 180 mm
19-302	80 x 100 mm



**FORCEPS
JAR**

	Size
19-303	55 x 100 mm
19-304	55 x 140 mm
19-305	55 x 170 mm
19-306	55 x 180 mm
19-307	80 x 100 mm



**FORCEPS
JAR**

	Size
19-308	55 x 100 mm
19-309	55 x 140 mm
19-310	55 x 170 mm
19-311	55 x 180 mm
19-312	80 x 100 mm



**FORCEPS
JAR**

	Size
19-313	55 x 100 mm
19-314	55 x 140 mm
19-315	55 x 170 mm
19-316	55 x 180 mm
19-317	80 x 100 mm



COTTON HOLDER
19-318



GALIPOTS

	Capacity
19-319	2 Ounces
19-320	3 Ounces
19-321	4 Ounces
19-322	5 Ounces
19-323	6 Ounces
19-324	7 Ounces
19-325	8 Ounces



GALIPOTS

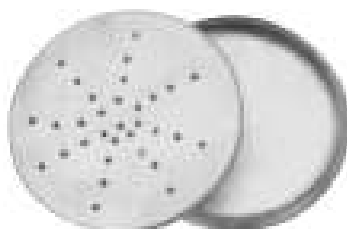
	Capacity
19-326	2 Ounces
19-327	3 Ounces
19-328	4 Ounces
19-329	5 Ounces
19-330	6 Ounces
19-331	7 Ounces
19-332	8 Ounces



SPRIT LAMP
19-333
100 ml.



INDO BOX ROUND
19-334



NEEDLE CASE
19-335



MEASURING JUG
Capacity
19-336 1.00 Ltr
19-337 1.50 Ltr
19-338 2.00 Ltr



MEDICINE CUP GRADUATED
Capacity
19-339 50 ml
19-340 60 ml
19-341 100 ml



BUCKET WITH LID
Capacity
19-342 10 Ltr
19-343 12 Ltr
19-344 15 Ltr



SPUTUM MUG
19-345
100 x 50 mm



ENEMA CANE
Capacity
19-346 0.5 Ltr
19-347 1.5 Ltr
19-348 2.0 Ltr



DUST BIN
19-349
20 Ltr



ROUND BEDPAN
19-350
300 x 85 mm



BEDPAN
19-351
Size: Adult, Child



BEDPAN
19-352
Size: Adult, Child



FUNNAL
19-353
100 mm



URINAL - FEMALE
19-354

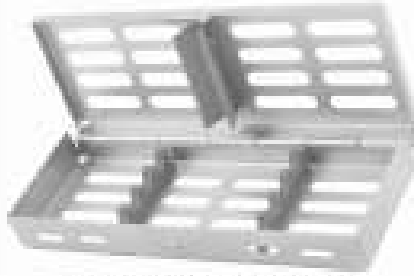


URINAL - MALE
19-355

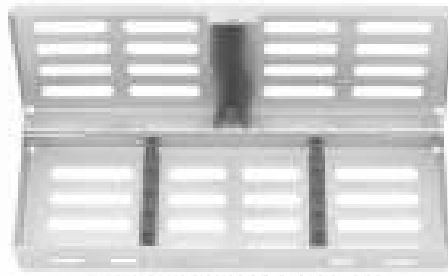


SHAVING MUG
19-356
100 mm

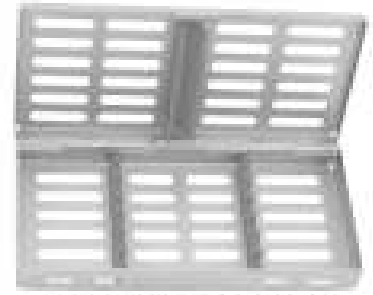
INSTRUMENTS MANAGEMENT SYSTEM



Cassette For 4 Instruments
19-357



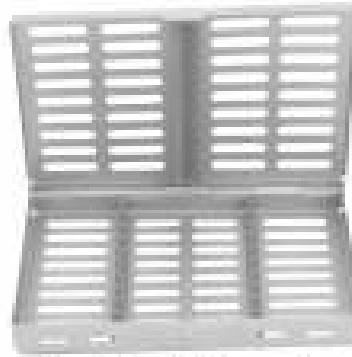
Cassette For 5 Instruments
19-358



Cassette For 6 Instruments
19-359



Cassette For 7 Instruments
19-360



Cassette For 10 Instruments
19-361



Cassette For 20 Instruments
19-362



Cassette For Extraction Forceps
19-363



Cassette For Root Elevator
19-364



19-365
Cassette Tray
15 Pcs



19-366
Cassette Tray
15 Pcs



Instruments Cassette
19-367 5 Pieces Cassette
19-368 7 Pieces Cassette
19-369 10 Pieces Cassette



19-370
18×11×3.5cm
Extra large cassette for 6
Instruments, with compartment
for small parts hinged lids

STERILIZING MESH TRAY

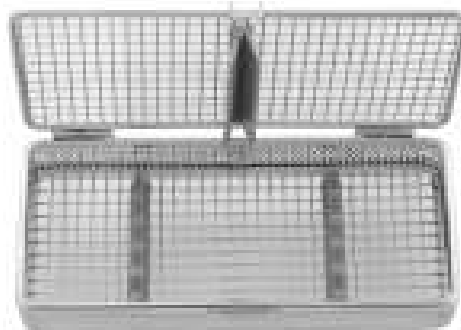
Different sizes & dimensions
are available at buyer's demand



MESH TRAYS

19-371

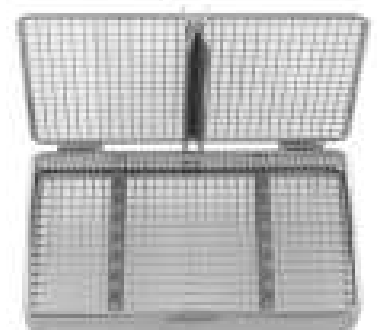
Different sizes & dimensions
are available at buyer's demand



MESH TRAYS

19-372

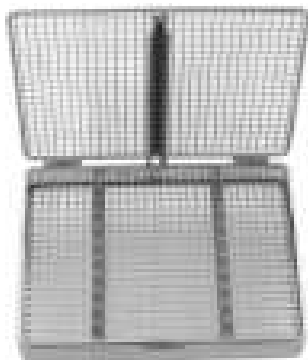
05 Pcs



MESH TRAYS

19-373

07 Pcs



MESH TRAYS

19-374

10 Pcs



MESH TRAYS

19-375

20 Pcs



19-376

Mesh Cassettes
5 Pieces, 7 Pieces, 10 Pieces,
15 Pieces & 20 Pieces



MESH TRAY

- 19-377 240x130x50mm
- 19-378 240x130x60mm
- 19-379 240x250x50mm
- 19-380 240x250x60mm
- 19-381 480x250x50mm
- 19-382 480x250x60mm
- 19-383 480x250x70mm



MESH TRAY

- 19-384 240x250x 50mm
- 19-385 240x250x 60mm
- 19-386 240x250x 70mm
- 19-387 480x250x 50mm
- 19-388 480x250x 60mm
- 19-389 480x250x 70mm
- 19-390 480x250x100mm



MESH TRAY

- 19-391 240x250x50mm
- 19-392 240x250x60mm
- 19-393 240x250x70mm
- 19-394 280x250x50mm
- 19-395 280x250x60mm

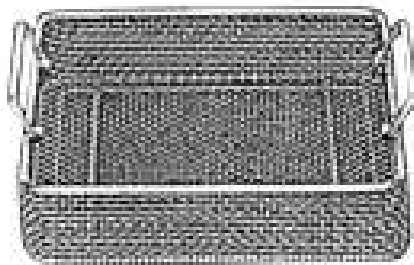


MESH TRAY

- 19-396 280x250x 70mm
- 19-397 280x250x100mm
- 19-398 280x250x 50mm
- 19-399 280x280x 60mm
- 19-400 280x280x 70mm
- 19-401 300x280x 60mm

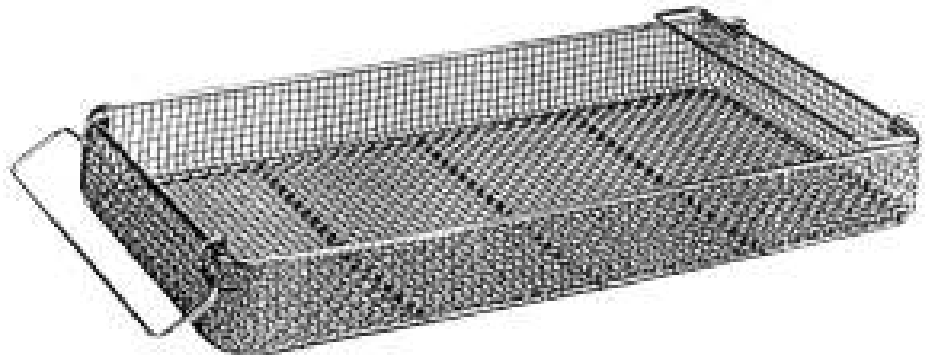
PERFORATED BASKETS

perforiert Körbe | paniers perforés
Cestas perforadas | ceste forate



MESH BASKET

19-402 240 x 258 x 50 mm
19-403 250 x 240 x 100 mm
19-404 240 x 250 x 60 mm



MESH BASKET

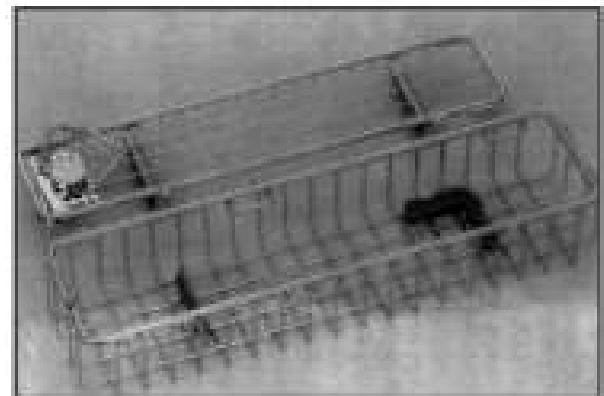
19-405 480 x 258 x 50 mm
19-406 480 x 258 x 100 mm
19-407 520 x 258 x 60 mm
19-408 520 x 258 x 70 mm
19-409 450 x 340 x 70 mm
19-410 320 x 230 x 70 mm



MESH BASKET

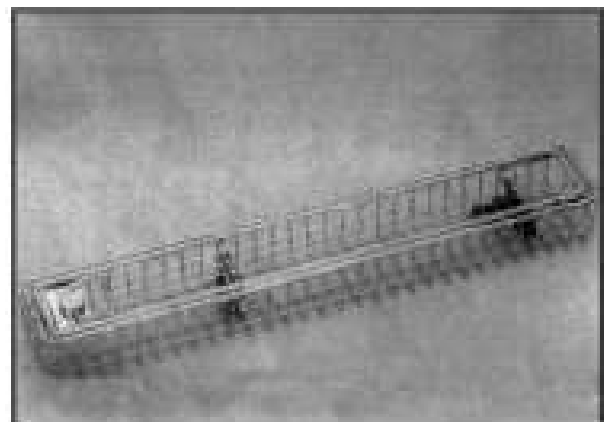
With Perforated Sheet Side

19-411 230 x 130 x 50 mm
19-412 230 x 130 x 60 mm
19-413 240 x 130 x 50 mm
19-414 240 x 130 x 60 mm
19-415 240 x 250 x 50 mm
19-416 240 x 250 x 60 mm
19-417 480 x 250 x 50 mm
19-418 480 x 250 x 60 mm
19-419 480 x 250 x 70 mm
19-420 300 x 300 x 50 mm
19-421 350 x 350 x 60 mm
19-422 470 x 400 x 60 mm
19-423 480 x 480 x 50 mm
19-424 480 x 480 x 60 mm
19-425 500 x 300 x 50 mm
19-426 520 x 300 x 50 mm
19-427 520 x 300 x 60 mm
19-428 550 x 430 x 50 mm
19-429 600 x 300 x 60 mm



ARTHROSCOPE BASKET

19-430 290 x 80 x 52 mm



ENDOSCOPE BASKET

19-431 460 x 80 x 52 mm
19-432 660 x 80 x 52 mm
19-433 670 x 80 x 52 mm

STERILIZING FORCEPS

Sterilisieren Zange

Pinces stérilisation

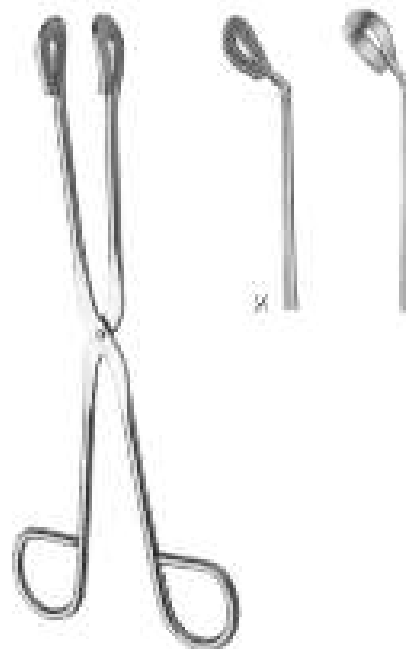
Pinzas de esterilización

Pinze di sterilizzazione



DAVIS

19-434 16 cm, 6 1/4"
19-435 20 cm, 8"
19-436 24 cm, 9 1/2"



UTILITY

19-437 20 cm, 8"
19-438 28 cm, 11"



19-439 20 cm, 8"
19-440 25 cm, 10"
19-441 30 cm, 11 3/4"



ROGGE
19-442
27 cm, 11"



CHEATEL
Box Joint
19-443
27 cm, 11"



CHEATEL
Screw Joint
19-444
27 cm, 11"

DESCRIPTION	PAGE#
A	
ABACE STOMACH INTESTINAL TWIN CLAMP FORCEPS	344
ADDOMEN / SADDLEDAG CANNULAS	413
ADOMINAL RETRACTORS	189-191
ADOMION FORCEPS - OVAL CURETTES	480
ABRAHAM TONGUE KNIFE	31-389
ABRE BOCA MC HYDR C/3 LAMINAS S/ SUCCALO RETRACTORS	199
ABRE BOCA RETRACTORS	199
ACCESSORIES FOR SYRINGES	489
ADLERKRENTZ DRESSING FORCEPS	69
ADLERKRENTZ TISSUE FORCEPS	69
ADSON BAYONET DRESSING FORCEPS	67
ADSON BROWN	71
ADSON BROWN TISSUE	71
ADSON DRILL GUIDE	338
ADSON ELEVATOR	281
ADSON FORCEPS	68
ADSON HAEMOSTATIC FINE POINT FORCEPS	62
ADSON HAEMOSTATIC TISSUE FORCEPS	62
ADSON NEEDLE HOLDERS	163
ADSON NERVE DURA HOOK	243
ADSON RETRACTOR	198
ADSON SUCTION TUBES	17
ADSON TISSUE & DRESSING FORCEPS	70-71
ADSON TISSUE & DRESSING FORCEPS T/C	77
ADSON TISSUE FORCEPS	71
ADSON TISSUE FORCEPS T/C	77
ADSON-BROWN TISSUE & DRESSING FORCEPS	76
ADSON-BROWN TISSUE FORCEPS T/C	77
ADSCULAP SPONGE & DRESSING FORCEPS	88
AGRIUS DIMOHAN BREAST DISSECTOR, SET OF 2	162
AGUCH FORCEPS	179
ALAN-PARKS SPECULUM	358
ALGERDYCE ELEVATORS	399
ALEXANDER BIOPSY AND SPECIMEN FORCEPS	388
ALEXANDER CHISEL	185
ALEXANDER GONGE	188
ALEXANDER PERIOSTEAL ELEVATOR	262
ALLEN INTESTINAL CLAMP	341
ALLIGATOR FORCEPS	334
ALLIS TISSUE FORCEPS	338
ALLIS TISSUE GRASPING FORCEPS	338
ALLIS-ADAM INTESTINAL AND TISSUE GRASPING FORCEPS	338
ALLISON LUNA SPATULA RETRACTOR	278
ALMI RETRACTOR	191
AMPUTATING & RESECTION SAWS	182
AMPUTATION KNIFE	86
ANASTORPHON STETHOSCOPE	61
ANASTOMOSIS CLAMPS, LIGATURE FORCEPS	368
ANDERSON BEAR CLAW RETRACTOR	177
ANDERSON-ADSON RETRACTOR	198
ANDERSON-NEVERT OSTEOPLATE	187
ANDREWS-PYNDON SUCTION TUBE	17
ANEURYSM CLAMPS	271
ANGLED BLADE PLATE	334
ANTHEM CURETTES	376
APPLYING FORCEPS FOR BULLDOG CLAMPS	364
APPLYING FORCEPS MINI	341
APPLYING FORCEPS STANDARD	341
ARCUS MARGINALIS DISSECTOR	164
AREOLA MARKERS, BREAST DISSECTORS AND ELEVATOR	162
ARUGA NEEDLE HOLDERS	118
ARUGA NEEDLE HOLDERS T/C	118
ARTERY SCISSORS	48
ARTHROSCOPIC BASKET	433
ASH SEPTUM FORCEPS	332
ATRAUMA MICRO BULLDOG CLAMPS	364
AUFRICH NASAL RETRACTORS WITH FIBER OPTIC	178
AUFRICH NASAL RETRACTOR	171-173
AUFRICH NASAL SAW	314
AUFRICH RETRACTOR SPECULUM	333
AUFRICH WALTER NASAL RETRACTOR	171
AUTOCLEANABLE	427
AUTOPSY KNIFE	31
AUYARD SPECULUM & RETRACTOR	377
AUYARD SPECULUM	378
AUYARD STENER SPECULUM	378
AZRE CONE KNIFE	81-388
B	
BANCOCK INTESTINAL & TISSUE GRASPING CLAMP FORCEPS T/C	343
BANCOCK SEIZING FORCEPS	343
BANCOCK TISSUE GRASPING FORCEPS	343
BABINSKY HAMMER	62
BABY ALLIS TISSUE FORCEPS	338
BABY ORLE-WOOD NEEDLE HOLDER	161
BABY ORLE-WOOD NEEDLE HOLDERS T/C	115
BABY METZGERBAUM SUPER-CUT SCISSORS	66
BABY YANKAER SUCTION TUBE	17
BABY-DOYER INTESTINAL FORCEPS CLAMPS	343
BABY-HOCHER INTESTINAL FORCEPS CLAMPS	343
BABY-BIKULICZ HAEMOSTATIC TISSUE FORCEPS	68
BABY-ROUX RETRACTOR	148
BACHHAUS CLIP TOWEL FORCEPS	93
BACHHAUS TOWEL FORCEPS	93
BAILEY-GIBSON RIB CONTRACTORS	277

DESCRIPTION	PAGE#
BAILEY-GIBSON RIB CONTRACTORS	277
BAILEY-OSLU SAW	289
BAINBRIDGE INTESTINAL FORCEPS CLAMPS	344
BAINBRIDGE PERIPHERAL VASCULAR CLAMPS	370
BARKS COMMON RILE DUCT DILATORS, MALLEABLE	361
BALFOUR RETRACTOR	198
BALFOUR-BARY RETRACTOR	188
BALL & SOCKET TOWEL FORCEPS	93
BALLENGER KNIFE	319
BALLENGER-HAJEK PERIOSTEAL SEPTUM ELEVATORS	313
BANDAGE SCISSORS	52
BANK BONE SCREWDRIVER	211
BARANY NOISE DRUM	299
BARNES-NEVILLE OBSTETRICAL FORCEPS	488
BARNES-NEVILLE SIMPSON	488
BARNHILL ADEMOID CURETTE	315
BARON SUCTION TUBES	18
BARR CRYPT HOOK	22
BARR FISTULA PROBE	22
BARR RECTAL SPECULUM	359
BARRAQUER SOLID BLADE WIRE SPECULUM	294
BARRAQUER WIRE SPECULUMS	294
BARRAQUER CLIA FORCEPS	74
BARRAQUER MICRO NEEDLE HOLDER T/C	139
BARRAQUER MICRO NEEDLE HOLDERS	109
BARRAQUER NEEDLE HOLDERS	109,287-289
BARRAQUER SCISSORS	49
BARRAQUER-TROUTMAN NEEDLE HOLDERS	110
BARRER MCJONNET HEMORRHOIDS, LIGATOR FORCEPS	384
BARRITT TENACULUM FORCEPS	388
BARR-SHIL FORDS INTESTINAL RECTAL SPECULUM	361
BAUER RETRACTOR WITH FIBER OPTIC	174
BAUMGARTNER NEEDLE HOLDER	181
BAUMGARTNER NEEDLE HOLDERS T/C	113
BAYONET MICRO KERRISON LAMINECTOMY FORCEPS	282
BAYONET SPUR-LID KERRISON LAMINECTOMY FORCEPS	282
BEACHAM AMNIOPLATE	388
BEAVER SCALPEL HANDLE	25
BECKMAN ADEMOID CURETTE	315
BECKMAN RETRACTOR	197
BECKMANN ADEMOID CURETTE	315
BECKMANN NASAL SPECULUM	365
BECKMAN-WETTLANDER RETRACTOR	198
BEHNEY	429
BEHNEY WIRE CUTTING SCISSORS	49
BEHR CLIA FORCEPS	74
BEHNDING DEVICE	232
BEHNDOLE HAEMOSTATIC FORCEPS	65
BEHNDOLE HAEMOSTATIC TISSUE FORCEPS	65
BERNET RETRACTOR	149
BENSAUDE INTESTINAL RECTAL SPECULUM	361
BERGER CERVICAL BIOPSY AND SPECIMEN FORCEPS	383
BERGMANN MALLETS	191
BERGMANN SCISSORS	51
BERKE PROPS FORCEPS	388
BERLINER HAMMER	82
BERNHARD TOWEL FORCEPS	94
BERTHLOW MEASURING DEVICE	13
BEVER HANDLE	26
BEYER BONE EAR RONGEURS	221
BEYER BONE RONGEUR	213
BIGGS BAMBAPLASTY RETRACTOR	187
BI, OBSTETRICAL HOLDER	488
BILBAU EAR LOOP	388
BIMANUAL HAND ASPIRATION	282
BIMANUAL HAND IRRIGATION	282
BIVOLVE PROBE	27
BIOPSY AND SPECIMEN FORCEPS	388
BIOPSY AND SPECIMEN FORCEPS HANDLE ONLY	382
BIOPSY CURETTES	388
BIOPSY CURETTES, ASPIRATING CURETTES	387
BIRCH PROCAR	15
BIRCHER MENISCTOMY KNIFE	389
BIRCHER-GARSKO BONE HOLDING FORCEPS	221
BISHOP BONE CLAMP	223
BLACK LIME KERRISON LAMINECTOMY PUNCH	281
BLADDER NECK SPREADER, BLADDER RETRACTORS	384-385-386
BLADE HOLDER BLADE BREAKER & HOLDER, WITH RATCHET LOCK	26
BLAKE DOUBLE ENDED	388
BLAKE GALL STONE FORCEPS	388
BLAKE UTERINE CURETTES	489
BLALOCK RIB CONTRACTORS	277
BLOHMKE TONGUE FORCEPS	389
BLOOD DOOP	199
BLOUNT KNEE RETRACTOR	139
BLOUNT RETRACTOR	289
BLOINERTHAL BONE RONGEUR	212
BOLHER BONE CUTTING RONGEUR FORCEPS	217
BOLHER BONE RONGEUR	211
BOLHER KIRSCHNER EXTENSION BOWS	233
BONE NASAL FRACTURE ELEVATOR	212
BONE CHISELS & GONGES	185-188-187-189-189
BONE CURETTES	185-188-187-189-189
BONE CUTTING FORCEPS	217-218
BONE CUTTING RONGEUR FORCEPS	217
BONE FILES	183
BONE HOLDING CLAMPS - BONE HOLDING FORCEPS	221
BONE HOLDING FORCEPS - REPOSITION FORCEPS	222

DESCRIPTION	PAGE#
BONE HOLDING FORCEPS	323-324-325-326-327
BONE LEVERS	297-298
BONE MILL, WITH ASSEMBLING WRENCH	178
BONE REDUCTION FORCEPS	322-323-324-325-326-327
BONE REDUCTION ORTHOPEDIC FORCEPS	323
BONE RES SHEAR	283
BONE RONGEURS	272-273-274-275-276
BONE TAMP	184
BONN FORCEPS	285
BONNEY DISSECTING & TISSUE FORCEPS T.C	78
BONNEY TISSUE FORCEPS	84
BONNEY UTERUS HOLDING FORCEPS	387
BONNEY VAGINAL CLAMPS	383
BONNEY-BARKER DILATORS	389
BONNEY-BERKLEY UTERUS HOLDING FORCEPS	387
BOOK WALTER RETRACTOR	382
BOUCHERON EAR SPECULUM	246
BOWL	428
BOWLEY PAEDIATRIC TRACHEAL DILATOR	321
BOWLEY TROUSSEAU TRACHEAL DILATOR	321
BOWMAN LACRIMAL PROBE DOUBLE ENDED, STERLING SILVER	32
BOWMAN PROBE	32
BOX WITH FILTER INSTRUMENTS BOX	425
BOYNTON NEEDLE HOLDERS	118
BOYNTON NEEDLE HOLDERS T.C	118
BOYS-ALLAN TISSUE FORCEPS	238
BOEMAN DRESSING FORCEPS	383
BOEWMANN HAEMOSTATIC FORCEPS	88
BOEWMANN NEEDLE HOLDERS	183
BOEWMANN NEEDLE HOLDERS T.C	112
BRAIN RETRACTOR SELF RETAINING	298
BRAIN SPATULAS	241-242
BRAND TENDON FORCEPS	289
BRAND TENDON TUNELLING FORCEPS	289
BRAUN OBSTETRICAL FORCEPS	488
BRAUN TENACULUM FORCEPS SHARP	388
BRAUN UTERINE DEPRESSOR	389
BRAUN VAGINAL RETRACTOR	374
BRAUN MIDWIFERY DECAPITATING HOOK	285
BRAUN-STADLER PLASTER SCISSORS	82
BRAUNSTEIN CALIPER	284
BREAST DISSECTOR ANGULATED BLADE	183
BREAST DISSECTOR OVAL SPATULATED	183
BREAST DISSECTOR SPATULATED BLADE	183
BREAST DISSECTORS AND ELEVATOR	183
BREAST ELEVATOR FOR MAMMARY PLASTY	183
BREAST RETRACTOR, DOUBLE ENDED	188
BREAST RETRACTORS	188-187-188-189
BREAST SPATULA WITH HANDLE	186
BRESKY PELVIMETER, OBSTETRICAL FORCEPS	488
BRESKY SPECULUM	373
BRESKY SPECULUM VIENNA PATTERN	375
BREIBERICH CHANNEL RETRACTOR	178
BREIBERICH HANDBULAR CHANNEL RETRACTOR	174
BRESKY SPECULUM & RETRACTOR	373
BRINKERHOFF INTESTINAL RECTAL SPECULUM	381
BRISTOW BONE LEVER	287
BRISTOW'S BONE LEVER	284
BRISTOW-SANKART HUMBAL RETRACTOR	288
BRISTOW-SANKART SOFT TISSUE RETRACTOR	288
BRODE DIRECTOR	31
BROM HOOKLET RETRACTORS	128
BROMHO GOSPHAGOSCOPY FORCEPS	384
BROPHY DRESSING FORCEPS	82
BROPHY TISSUE FORCEPS	82
BROWN NEEDLE HOLDER	184
BRUSHING MACROPIER OTOSCOPE	287
BRUSHING SPATULA	128
BRUSHINGS SEPTATOR	288
BRUSHINGS COMPLETE	287
BRUSHINGS EAR SPECULUM COMPLETE SET	287
BRUSHINGS NASAL CUTTING FORCEPS	279
BRUSHINGS NASAL SPECULUM	282
BRUSHINGS RETRACTOR	232
BRUSHINGS TONGUE DEPRESSORS	225
BRUSHINGS TONGUE KNIFE	288
BRUSHINGS TONGUE SNARE	281
BRUSHINGS-BRUNK ANTRUM RETRACTOR	382
BRUNER RETRACTOR	143
BRUNING TONGUE KNIFE	31
BRUNNER INTESTINAL POLYOUS GRASPING FORCEPS	245
BRUNNER RETRACTORS WITH FIBER OPTIC	178
BRUNNER RES SHEARS	284
BRUNS BONE CURETTE	185-186
BRUNS SCISSORS	81
BUCK EAR POLYPUS FORCEPS	218
BUCK HAMMER	82
BUCK STITCH SCISSORS	43
BUCK EAR CURETTE	287
BUCKET WITH LID	428
BUCKLEY RETRACTOR	191
BUELLAU TROCAR	78
BUE HIRSCHMAN ANOSCOPE INTESTINAL RECTAL SPECULUM	352
BUE SUCTION TUBE	32
BUNNELL DRILL	228
BUNNELL TENDON STRIPPERS	285-286
BURFORD RES RETRACTORS	281
BURKE BIDPSY FORCEPS	281

DESCRIPTION	PAGE#
BURNHAM BANDAGE PLASTER SCISSORS	51
BUSCH PLASTER SCISSORS	82
BUTTERFLY GROOVED DIRECTOR WITH TORQUE TIE PLAIN END	21
BYRD, SUCTION TUBE	17
C	
C-CLAMP FORCEPS	231
CAIRNS HAEMOSTATIC FORCEPS	82
CAIRNS-DOTTUSHING TISSUE & DRESSING FORCEPS	88
CALLIPER FIXED	284
CANNULAS	221-415-416-417
CANNULAS CANNULAS FOR INFLTRATION	489
CANNULAS FOR INFLTRATION	489
CANNULATED WIRE / PIN CUTTER	279
CAPENER OSTIOTOME	188
CAPLAN SEPTUM FORCEPS	323
CAPSULE FORCEPS, LIGATURE CARRYING FORCEPS	289
CAPSULE RETRACTOR	289
CAPSULECTOMY SCISSORS WARMAE	289
CARBELL FORCEPS	74
CARPENTER ENUCLEATOR	232
CARROLL NEEDLE HOLDERS T.C	111
CARROLL PERIOSTEAL ELEVATOR	284
CARROLL POCKET SCHEMETER	72
CARROLL TENDON FORCEPS	289
CARTILAGE AND BONE INSTRUMENTS	170
CARTILAGE CUTTING BLOCK, TEFLOM	170
CASPAR BONE TAMPER	184
CASPAR RETRACTOR	127
CASPAR TYPE INTERVERTEBRAL DISC RONGERS	248
CASSETTE FOR 10 INSTRUMENTS	431
CASSETTE FOR 20 INSTRUMENTS	431
CASSETTE FOR 4 INSTRUMENTS	431
CASSETTE FOR 5 INSTRUMENTS	431
CASSETTE FOR 6 INSTRUMENTS	431
CASSETTE FOR 7 INSTRUMENTS	431
CASSETTE FOR EXTRACTION FORCEPS	431
CASSETTE FOR ROOT ELEVATOR	431
CASSETTE TRAY 16 PCB	431
CAST SPREADER MODEL USA	211
CASTAREDA MULTIPURPOSE CLAMP & STRAINMATIC CARDIOVASCULAR FORCEPS	274
CASTAREDA RES RETRACTORS	282
CASTROVIEJO CALIPER	284
CASTROVIEJO BLADE BREAKER & HOLDER, WITH PUSH-PULL LOCK	28
CASTROVIEJO BONE CALIPER CURVED	12
CASTROVIEJO BONE CALIPER STRAIGHT	12
CASTROVIEJO CORNEAL MICRO SCISSORS	49
CASTROVIEJO EYE SPECULUM	151
CASTROVIEJO EYE VIEW CALIPER	151
CASTROVIEJO MICRO NEEDLE HOLDER T.C	124
CASTROVIEJO NEEDLE HOLDER	189-190-289
CASTROVIEJO NEEDLE HOLDERS T.C	118-119
CASTROVIEJO OLSEN HEGAR / NEEDLE HOLDERS / SCISSORS	110
CASTROVIEJO SCISSORS	49
CASTROVIEJO SCISSORS T.C INSERT	84
CASTROVIEJO T.C	287
CASTROVIEJO SPARR CALIPER	73
CATHER TRAY PERFORATED BOX	425
CATHETERS	282
CATLIN AMPUTATION	38
CATLIN DISSECTING KNIVES	38
CAWOGG MINNESOTA CHEEK RETRACTOR	234
CEPSULECTOMY SCISSORS	288
CERVICAL BIOPSY AND SPECIMEN FORCEPS	288-281-282-284
CERVICAL TRACTION TONGS	238
CHALAZION CLAMP	285
CHALAZION FORCEPS	285
CHANDLER BONE ELEVATOR	282
CHAPUT HAEMOSTATIC FORCEPS	89
CHAPUT TISSUE FORCEPS	239
CHARNEY TISSUE FORCEPS	81
CHARNEY-MULLER	233
CHARRERE AMPUTATOR & RESECTION	32
CHARRERE BONE SAW	182
CHARRERE BONE SAW COMPLETE	182
CHARRERE SAW	182
CHEATEL STERILIZING FORCEPS BOX JOINT	424
CHEATEL STERILIZING FORCEPS SCREW JOINT	424
CHEEK AND LIP RETRACTOR DR	178
CHEEK RETRACTOR	234
CHEEK AND LIP RETRACTOR	148
CHELSEA-EXTON INTESTINAL RECTAL SPECULUM	352
CHERON FORCEPS	29
CHERRY RES RETRACTORS	279
CHEVALIER-JACKSON FORCEPS	234
CHEVALIER-JACKSON TRACHEA TUBES	237
CHICHELLE (BLUMENTHAL) RONGEUR	212
CHILD HERNIA DIRECTOR	287
CHLDS TISSUE FORCEPS	75
CHISEL	184-185-187
CHISEL BLADE HANDLE	184
CHISEL BLADE KEY	184
CHISELS, OSTIOTOMES FOR RHINOPLASTIC	189
CHRISTOPHE HAEMOSTATIC FORCEPS	81
CLIA FORCEPS	74
CWELLI CHISEL	189
CIRCUMCISION SHIELD	284

DESCRIPTION	PAGE#
CITELLI BONE EAR FORCEPS	321
CLARK SPECULUM	384
CLEVELAND BONE CUTTING RONGEUR FORCEPS	216
CLEVELAND BONE RONGEUR	213
CLEVELAND-GARDNER BONE CUTTING RONGEUR FORCEPS	217
CLIPS & APPLYING FORCEPS	241
CLIPS MAYO	33
CLOWARD INTERVERTEBRAL DISC RONGEUR	248
CLOWARD RETRACTOR	237
CLOWARD VERTEBRAL CERVICAL SPREADER	238
CLUTTON BONGERS	362
COAKLEY ANTRUM CURETTE	373
COAKLEY UTERINE DEPRESSOR	389
COAKLEY TROCER	35
COARCTATION CLAMPS	267
COBB CHISEL / OSTEOTOMES	198
COBB GRUZE	198
COBB MODIF	194
COBB PERIOSTEAL ELEVATOR	204
COBB SPINAL ELEVATOR	194
COHEN RIPPERS	47
COLE-PARKER DISSECTING BLADE REMOVER FOR BLADE HANDLE	38
COLLIER FORCEPS	283-285-287
COLLIER HAEMOSTATIC FORCEPS	81
COLLIER NEEDLE HOLDERS	165
COLLIN DISSECTING KNIFE	28-29
COLLIN DRESSING HAEMOSTATIC FORCEPS	88
COLLIN FORCEPS	78
COLLIN GRASP FORCEPS	348
COLLIN KIDNEY ELEVATING STONE CLAMPS FORCEPS	387
COLLIN MALLETS	189
COLLIN OBSTETRICAL FORCEPS	484
COLLIN PELVIMETER, OBSTETRICAL FORCEPS	488
COLLIN RETRACTOR	141/189-188
COLLIN RIB SHEARS	284
COLLIN SCALPEL HANDLE # 3 BLADE	28
COLLIN SPONGE & DRESSING FORCEPS	97, 188
COLLIN TISSUE GRASPING FORCEPS	348
COLLIN VAGINAL SPECULUM	378
COLLIN VIRGIN SPECULUMS	378
COLLIN-DUVAL FORCEPS	88
COLLING-DRESSING HAEMOSTATIC FORCEPS	88
COLLIN-HARTMANN RETRACTOR	132
COLLIN-TISSUE GRASPING FORCEPS	348
COMBINATION Mallet	181
COMPRESSION POSITIONING DRILL BIT	331
CONRYN BERKELEY VULVA SELF RETAINING RETRACTOR	379
CONCAVE FRIEDMAN HOOK RETRACTOR	177
CONDUCTOR/REVERSON NEEDLES	133
CONE KNIFE	31
CONE RETRACTOR	188
CONVENTIONAL LARYNGOSCOPE SET	84-85
CONVERSE BLADE NASAL RETRACTOR	137
CONVERSE HOOK	138
CONVERSE NASAL KNIFE	389
CONVERSE NEEDLE HOLDERS T.C	115
CONVEY FRIEDMAN HOOK RETRACTOR	177
COOLEY ANASTOMOSES CLAMPS	275
COOLEY BLADE AORTIC DILATOR	278
COOLEY EYE FORCEPS	287
COOLEY INTRACARDIAC NEEDLE HOLDERS	187
COOLEY INTRACARDIAC NEEDLE HOLDERS T.C	115
COOLEY MULTI PURPOSE VASCULAR CLAMPS	276
COOLEY PEDIATRIC VASCULAR CLAMPS	275
COOLEY REVERSE CUT SCISSORS	41
COOLEY RIB RETRACTORS	279,288
COOLEY VASCULAR FORCEPS	288
COOLEY VASCULAR SCISSORS	42
COOLEY, SUCTION TUBE	17
COOLEY BAUMGAFFEN WIRE TWISTER NEEDLE HOLDERS T.C	118
COOPER NEEDLE	133
CORN HOOK	387
CORNICAL FORCEPS	285,287
CORNICAL SCISSORS	288
CORONAL BROW LIFT RETRACTOR	177
CORWEN AOR ROUND SCALPEL HANDLE	33
CORWEN NEEDLE HOLDERS T.C	121
CORWEN ROUND AOR SCALPEL HANDLE	33
CORYLLOS RETRACTOR	142
COTTLE ALAR RETRACTOR	171
COTTLE CARTILAGE CRUSHER	179,332
COTTLE CHISEL	188
COTTLE GUIDE SUPPORT FOR OSTEOTOMES	332
COTTLE HANDLE	332
COTTLE MALLETS	189
COTTLE NASAL KNIFE	389
COTTLE NASAL SAW	314
COTTLE NASAL SPECULUM	388
COTTLE OSTEOTOMES	187, 188
COTTLE PERIOSTEAL ELEVATOR	184
COTTLE PERIOSTEAL ELEVATOR/RESPIRATORY	185
COTTLE PERIOSTEAL SEPTUM ELEVATORS	372
COTTLE RETRACTOR	132
COTTLE SCISSORS	44
COTTLE SEPTUM ELEVATORS RESPIRATORY	311
COTTLE-KADANJIAN BONE CUTTING RONGEUR FORCEPS	216
COTTLE-WALSHAM SEPTUM FORCEPS	330
COTTON HOLDER	383

DESCRIPTION	PAGE#
COTTON HOLDER	428
COUNTERSINK	229
COUPLAND SUCTION TUBE	17
COUPLING PIECE ASPHRATRO CURETTE	397
CRAFOORD HAEMOSTATIC FORCEPS	85
CRAFOORD-SELLERS HAEMOSTATIC FORCEPS	85
CRAUS NASAL POLYPUS AND SEPTUM FORCEPS	217
CREGO PERIOSTEAL ELEVATOR	201
CRILE HAEMOSTATIC FINE POINT FORCEPS	83
CRILE HAEMOSTATIC FORCEPS	88
CRILE HAEMOSTATIC TISSUE FORCEPS	83
CRILE HOOKLET & SKIN HOOKS	128
CRILE NEEDLE HOLDERS	188
CRILE RETRACTOR	139
CRILE-MURRAY NEEDLE HOLDERS	188
CRILE-WOOD NEEDLE HOLDER	182
CRILE-WOOD NEEDLE HOLDERS T.C	111
CRUTCHFIELD DRILL BIT	238
CRUTCHFIELD DRILL	238
CRUTCHFIELD TRACTION TONGS	238
CUP SHAPED BRONCO DEODYPHAGOSCOPY FORCEPS	333-338
CUP SHAPED FORCEPS	334
CURETTE	108,188,282
CUSCO VIRGIN SPECULUMS	378
CUSCO VAGINAL SPECULUM	388
CUSCO VAGINAL SPECULUM FOR YERGES	289
CUSCO VAGINAL SPECULUM SWAGE PATTERN	388
CUSHING DECOMPRESSION RETRACTOR	288
CUSHING DRESSING FORCEPS T.C	78
CUSHING HAND DRILL BIT	235
CUSHING HOOKLET RETRACTORS	138
CUSHING INTERVERTEBRAL DISC RONGEUR	247,248
CUSHING LAMRECTOMY RONGEUR	247
CUSHING NERVE DURA HOOK	242
CUSHING NERVE DURA HOOK RETRACTOR	243
CUSHING NERVE HOOK	244
CUSHING PERIOSTEAL ELEVATOR	203,204
CUSHING TISSUE FORCEPS T.C	78
CUSHING VEIN RETRACTOR	288
CUSHING BRAN SPATULA	241
CUSHING-KOCHER HOOKLET RETRACTORS	138
CUZZI-DYUM CURETTE	485
CZERNY RECTAL SPECULUM	299
CZERNY TENACULUM FORCEPS	388

D

DERRICK FORCEPS	88
DELOREN CRANIAL RONGEUR	238
DANDY HAEMOSTATIC FINE POINT FORCEPS	88
DANDY HAEMOSTATIC FINE POINT TISSUE FORCEPS	88
DANDY HAEMOSTATIC FORCEPS	88
DANDY HAEMOSTATIC TISSUE FORCEPS	88
DANDY NERVE DURA HOOK	242
DARLING RETRACTOR	182
DARRACH ELEVATOR	284
DARTIGUES UTERINE ELEVATING FORCEPS	387
DAUBENSPERK BONE CURETTE	187
DAVIDSON RETRACTOR	182
DAVIS DURA DISSECTOR	242,244
DAVIS GUDE FOR GIGLI SAWS	238
DAVIS STERILIZING FORCEPS	434
DAVIS-BOYLE MOUTH GAG HANDLE	328
DAVIS-BOYLE MOUTH GAG COMPLETE SET WITH FIVE BLADES	328
DAY HOOKLET & SKIN HOOKS	128
DE BAKEY BECK MULTI-PURPOSE VASCULAR CLAMPS	273
DE BAKEY BILL DODS CLAMPS	364
DE BAKEY DRESSING FORCEPS T.C	78
DE BAKEY FEMUR RETRACTOR	187
DE BAKEY LIGATURE FORCEPS	288
DE BAKEY MULTI PURPOSE VASCULAR CLAMPS	273,274,274
DE BAKEY NEEDLE HOLDERS	188
DE BAKEY NEEDLE HOLDERS T.C	118
DE BAKEY PEDIATRIC VASCULAR CLAMPS	273
DE BAKEY PERIPHERAL VASCULAR CLAMPS	288,278
DE BAKEY SUCTION TUBE	17
DE BAKEY VASCULAR FORCEPS	288
DE BAKEY VASCULAR SCISSORS	41,42
DE BAKEY-MOSQUITO VASCULAR FORCEPS	288
DE BAKEY-SANKIN VASCULAR FORCEPS	288
DE LEE OBSTETRICAL FORCEPS	487
DE LEE PELVIMETER, OBSTETRICAL FORCEPS	488
DE MARTEL SAW CONDUCTOR	238
DE MARTEL-WOLFFSON ANASTOMOSES CLAMPS	348
DE MARTEL-WOLFFSON CLAMP HOLDER	348
DE MARTEL-WOLFFSON CLOSING FORCEPS	348
DE YLBISS SKULL FORCEPS	238
DE YLBISS VIRGIN SPECULUMS	378
DEAN (BLUMENTHAL) RONGEUR	213
DEAN RONGEUR	212
DEAN-DELLICATS DISSECTING SCISSORS	42
DEANER OPERATING SCISSORS	35
DEANER RETRACTOR	144,174
DEBAKEY RIB RETRACTOR	279
DEBAKEY RIB RETRACTOR	279
DEBAKEY CARDIOVASCULAR NEEDLE HOLDERS	187
DEBAKEY CARDIOVASCULAR NEEDLE HOLDERS T.C	118
DEBAKEY DRESSING FORCEPS T.C	78
DEBAKEY GELPI RETRACTOR	182
DEBAKEY RIB RETRACTOR	279

DESCRIPTION	PAGE#
DE-BAKEY-BAHNSON TANGENTIAL OCCLUSION FORCEPS	271
DEBARY-COOLEY RETRACTOR	148
DEBAKEY-VASCULAR/EXTRA LIGHT NEEDLE HOLDERS T.C	178
DECKER INTERVERTEBRAL DISC RONGEURS	249
DEJERINS HAMMER	82
DELICATE WIRE CUTTER	228
DEHART MOUTH GAG	228
DEMS-BROWNE RETRACTOR	168
DEMP NEEDLE HOLDERS	168
DEMP NEEDLE HOLDERS T.C	178
DERMATOMES - TRANSPLANTATION KNIVES	32
DETRA MULTI PURPOSE VASCULAR CLAMPS	374
DERVICO-ADSON RETRACTOR	155
DESCHAMPS NEEDLE	123-124
DESJARDIN (SET 3 PIECES)	33
DESJARDINS GALL STONE FORCEPS	358
DESJARDINS HEMOSTATIC FORCEPS	87
DESJARDINS PROBE & CATCH WITH FLEXIBLE	381
DESMARRES L.S. RETRACTORS	133
DIAGNOSTIC PHTHOSCOPE SET	86
DIAGNOSTIC SETS	87, 88, 89
DICK HEMOSTATIC FORCEPS	82
DIFFENBACH DISSECTING KNIVES	28, 29
DIFFENBACH KNIVES	28
DIETRICH VASCULAR FORCEPS	268
DINGMAN BONE CLAMP	222
DINGMAN CARTILAGE ABRASERS SET OF TWO	178
DINGMAN CLEFT PALATE REPAIR MOUTH GAG	327
DIRECTOR PROBE END	31
DIRECTORS	31
DISSECTING & GYNECOLOGICAL SCISSORS	38, 40
DISSECTING & NASAL SCISSORS	42
DISSECTING DRESSING FORCEPS	64
DISSECTING FORCEPS	62
DISSECTING RITS	11, 12
DISSECTING KNIFE WITH METAL HANDLE	28
DISSECTING KNIVES	28, 28, 31
DISSECTING SCISSORS INCISION OPERATING SCISSORS	38
DISSECTING SET - POPULAR	11
DISSECTING SET - PRO	11
DISSECTING SET - SENIOR	11
DISSECTING SET - ADVANCED	11
DISSECTING SET OF 12 PCS	11
DISSECTING SET OF 8 PCS	11
DISSECTING TISSUE FORCEPS T.C	78
DISSECTORS AND ELEVATORS	194, 195, 171
DITTEL URETHRAL BOUGIES AND DELATING SOUNDS	363
DIXON-LOWLACE HEMOSTATIC FORCEPS	88
DOUBLE ACTION WIRE CUTTER	228
DOUBLE PRONG MICRO HOOK & BRIN HOOK	127
DOUGLAS GILL FORCEPS	74
DOUGLAS TROCAR	12
DOWNING CARTILAGE KNIFE	288
DOYEN DIRECTORS	21
DOYEN INTESTINAL FORCEPS CLAMPS	143, 144, 145
DOYEN MALLETS	181
DOYEN MYOMA SCREW AND FISTULA HOOK	386
DOYEN NEEDLE HOLDERS	188
DOYEN OPERATING, DISSECTING SCISSORS	38
DOYEN POZZI RETRACTOR	278
DOYEN PROBES & DIRECTORS	21
DOYEN RETRACTOR	145
DOYEN RIB REASPIRATORY	288
DOYEN RIB SHEARS	284
DOYEN SPECULUM & RETRACTOR	277
DOYEN SUPRA HOLLOW HANDLE	378
DOYEN TONGUE SPATULA	228
DOYEN TOWEL FORCEPS	82
DOYEN VAGINAL FLAT RETRACTOR	382
DOYEN VAGINAL RETRACTORS	148
DOYEN VAGINAL SPECULUM	374
DOYEN BABY INTESTINAL CLAMP	343, 344
DRESSING JAR	438
DRESSING JAR WITH KNOP	428
DRILL GUIDE	228
DRILL GUIDE WITH THREAD	231
DRILL POINTED GUIDE	231
DRILL SLEEVES	231
DUCKBILL EAR FORCEPS	323
DUEHRSSON DRESSING FORCEPS	88
DUEHRSSON TISSUE FORCEPS	88
DUNE TROCAR	15
DUMONT FORCEPS	73
DUPLAY SPONGE & DRESSING FORCEPS	87
DUPLAY SPONGE FORCEPS	88
DUPLAY TENACULUM FORCEPS	288
DURLEX STETHOSCOPE	81
DURLEX-BABY STETHOSCOPE	81
DURA DISSECTORS	344
DURA DISSECTORS	345
DURANTE TISSUE GRASPING FORCEPS	84
DUST BIN	438
DUNAL GRASP FORCEPS	338
DUNAL INTESTINAL & TISSUE GRASPING CLAMP FORCEPS T.C	342
DUNAL INTESTINAL AND TISSUE GRASPING CLAMP FORCEPS	342
DUNAL LUNG TISSUE FORCEPS	341
DUNAL TISSUE GRASPING FORCEPS	341
DUNAL-COLLIER GRASP FORCEPS	338

DESCRIPTION	PAGE#
E	
EAR CURETTES	387
EAR CURETTES AND SHARP SPOONS	388
EAR FORCEPS	383
EAR LOOPS - HOOKS	388
EAR POLYPUS FORCEPS	378
EAR POLYPUS SNARES	381
EAR SPECULA	294, 297
EAR SPECULA, ATOMIZER	298
EAR SPECULUM	285
ECHLIN-DUCKBILL BONE RONGEUR	214
ECKER SUCTION & IRRIGATION CANNULA	19
EISENBERG-MATHEN NEEDLE HOLDERS T.C	127
ELLIOT GASTRICAL FORCEPS	487
ELZASSER NEPHROSTOMY FORCEPS	258
EMMET FISTULA HOOK	298
EMMET SPONGE & DRESSING FORCEPS	89
ENDOSCOPE BASKET	433
ENDOTHELIAL GRASPING FORCEPS	289
ENEMA CANE	430
ENGL PLASTER SAW	183
ENGL, MODELL TOWEL FORCEPS	83
ENT MEDICAL DIAGNOSTIC SET	87, 88
ENT SPECULA	87, 88
ENT-DEAN SCISSORS	42
ENT-DEAN SCISSORS T.C INBERT	88
ENTRER CANNULAS	410, 411, 412
EPPENDORF BIOPSY FORCEPS	287
EPPENDORF BIOPSY AND SPECIMEN FORCEPS	288
ESMARCH KNIFE	81
ESMARCH SCISSORS	81
ESTRATTE PASQUE T.C NEEDLE HOLDERS	114
EUSTACHIAN CATHETERS	28
EVANS DRESSING FORCEPS T.C	78
EVANS PELVIC NEEDLE DRESSING FORCEPS T.C	78
EYES TONGUE SNAKE	281
EXTENSION BOWS	233
EXTRA 3CM NYLON FACE	181
EXTRA ORAL RETRACTOR	175
EYE FORCEPS	288, 289, 287
EYE HOLDERS	288
EYE INSTRUMENTS	287
EYE KNIVES	283
EYE SPECULUMS	282
F	
FACE CANNULAS	413
FANSLER OPERATING INTESTINAL RECTAL SPECULUM	282
FARBELF BONE HOLDING FORCEPS	223
FARBELF ELEVATOR	281
FARBELF RETRACTOR	148, 149
FARBELF-COLLIER ELEVATOR	281
FARBELF-LAMBOTTE BONE HOLDING FORCEPS	223
FARR WIRE RETRACTOR	191
FARRELL APPLICATOR	288
FARRELL ROUND SERRATED END	23
FAT INJECTION SYRINGES	423
FAT SUCTION SYRINGES	423
FALKNER ANTRUM CURETTE	310
FAURE HAEMORRHOID TISSUE FORCEPS	89
FAURE UTERINE BIOPSY FORCEPS	384
FAYALORO CORONARY SCISSORS	42
FEDTNER ODOMANCTIVA FORCEPS	286
FELHARD INTESTINAL POLYDUS GRASPING FORCEPS	245
FELCHENFELD FORCEPS	25
FER COTTON APPLICATOR	22
FEMALE BLADDER SOUND	383
FEMALE CATHETERS	383
FEMESTRATED HANDLE	71
FERGUSON-MOON RECTAL RETRACTORS	148
FERGUSON BONE HOLDING FORCEPS	222
FERGUSON SUCTION TUBES	18
FERGUSON TUBING CLAMP	84
FERGUSON-LACKLAND MOUTH GAG	228
FERRERA BREAST AUGMENTATION RETRACTOR	187, 188
FERRERA FACE LIFT RETRACTOR	174
FERRERA STYLE RETRACTOR	188
FERRIS SMITH MICRO KERRISON LAMINECTOMY RONGEURS	254, 255
FERRIS SMITH MICRO KERRISON LAMINECTOMY RONGEURS DOWNWARD	259
FERRIS SMITH MICRO KERRISON LAMINECTOMY RONGEURS UPWARD	259
FERRIS-SMITH INTERVERTEBRAL DISC RONGEURS	254
FERRIS-SMITH KERRISON LAMINECTOMY PUNCH	281
FERRIS-SMITH TISSUE FORCEPS	84
FERRISZELL PERICRURAL ELEVATOR	281
FIBER OPTIC LARYNGOSCOPE	85
FIBER OPTIC LARYNGOSCOPE MILLER	84
FIBULA BONE HOLDING FORCEPS	227
FINGER NAIL DRILL	289
FINGER NAIL RETRACTOR	130
FINOCHETTO (MODE) RIB RETRACTORS	280
FINOCHETTO NEEDLE HOLDERS	182
FINOCHETTO, RIB RETRACTORS	280, 282
FINOCHETTO-BABY RIB RETRACTORS	282
FINOCHETTO NEEDLE HOLDERS	188
FINOCHETTO NEEDLE HOLDERS T.C	113, 114
FINOCHETTO RETRACTORS	188
FINOCHETTO RETRACTORS	188

DESCRIPTION	PAGE#
FINSEN RETRACTOR	158
FISCH HOOKLET & SKIN HOOK	137
FISCH SUCTION & IRRIGATION CANNULA	18
FISCHER TENDON STRIPPERS	395
FISCHER TONGUE KNIFE AND DISSECTOR	366
FISTULA HOOK	386
FOURION HOOK	393
FLAP DISSECTOR	163
FLAT NOSE K-WIRE PLIERS	210
FLAT NOSE PLIERS	209, 210, 211
FLETCHER SPONGE FORCEPS	88
FLEURANT TROCAR	18
FLEXURAL ABDOMINAL SPATULA	158
FLUSH WIRE CUTTER	329
FLUSHING CURTETTES	366
FOERSTER-BALLENGER SPONGE FORCEPS	168
FOMAN OPERATING SCISSORS T/C INSERT	88
FOMAN RASP	183
FOMON CHISEL	189
FOMON NASAL KNIFE	369
FOMON NASAL RETRACTOR	172
FOMON NASAL SAW	374
FOMON RASP	184
FOMON RASP WITH TUNGSTEN CARBIDE T/C	373
FOMON SCISSORS	44
FOMAMICROMY KERRISCH LAMPECTOMY FORCEPS	382
FORCEPS FOR I.U.D REMOVING	380
FORCEPS JAR	429
FORSON BODY FORCEPS	378
FORSON BODY LEVER	378
FORSTER CONJUNCTIVA FORCEPS	388
FOWLER TONGUE KNIFE	31
FRAERKEL LARYNGEAL POLYPUUS FORCEPS	337
FRAZER HOOKLET & SKIN HOOK	137
FRAZIER 30" SUCTION TUBES	18
FRAZIER 45" SUCTION TUBES	18
FRAZIER NERVE DURA HOOK	343
FRAZIER NERVE DURA HOOK RETRACTOR	343
FRAZIER SUCTION TUBES	18
FREEMAN AREOLA MARKER	182
FREEMAN FLAP RETRACTOR	174
FREEMAN HOOK RETRACTOR	177
FREEMAN RETRACTOR HOOK RETRACTOR	177
FRIEER CHISEL	187
FRIEER D SEPTUM KNIFE	385
FRIEER ELEVATOR	188
FRIEER GAUGE	187
FRIEER NASAL KNIFE	389
FRIEER SEPTUM ELEVATOR	185
FRIEER SEPTUM ELEVATORS RASPARTORY	311
FRIEER SHIN HOOK	137
FRIEER TONGUE KNIFE	366
FRENCH TURNING FORK	388
FRENCH-EYE NEEDLE HOLDERS T/C	113
FRENCH-EYE NEEDLE HOLDER	187
FRENCH-EYE NEEDLE HOLDERS T/C	113
FROCHE ARTERY FORCEPS	93
FRIEDMANN BONE RONGEUR	371
FRIEDMANN RETRACTOR	378
FRETCH RETRACTOR	148
FRIESEN RETRACTOR	185, 186
FRONT & SIDE WIRE CUTTER	329
FRONTOGLABELLAR DISSECTOR	164
FRONTOTEMPORAL DISSECTOR	164
FRYKHOLM BONE RONGEUR	378
FUNNELL	428
G	
G LOVES BOX	425
GALAPOTS	429
GALL DUCT DILATOR	361
GALL STONE FORCEPS	368
GALLAHER BONE RASP	183
GALLAHER NASAL SAW	374
GALT BRACE HAND DRILL	326
GANSEN EAR CURETTE	368
GARRIGUE WEIGHTED VAGINAL SPECULUM	377
GASPAROTTI CANNULAS	418
GELFHORN BIOPSY FORCEPS	384
GELPI SKIN & VAGINAL RETRACTOR	187
GELPI VAGINAL RETRACTOR	187
GELPI VULVA SELF RETAINING	382
GELPI-LONTITE RETRACTOR	183
GELPI-PERINEAL RETRACTOR	183
GEMINI MIXTER HAEMOSTATIC FORCEPS	82
GERALD TISSUE & DRESSING FORCEPS	88
GERARD TISSUE & DRESSING FORCEPS	88
GERL TYING FORCEPS	388
GERSTER BONE HOLDING CLAMP	321
GERSTER-LOWMANN BONE CLAMP	321
GIERTZ-STELE RIB SHEARS	384
GIGLE WIRE SAW	328
GIGLE-STRULLY HANDLE FOR WIRE SAW	328
GILLES NEEDLE HOLDERS	184
GILLES NEEDLE HOLDERS T/C	174
GILLES SKIN HOOK	137
GILLES SLIM T/C NEEDLE HOLDERS WITH SCISSORS	174
GILLES TISSUE FORCEPS	82

DESCRIPTION	PAGE#
GILLES TISSUE FORCEPS T/C	79
GILIE - YANMAR	289
GLENORD PERFORATING FORCEPS	321
GLOVER BULLDOG CLAMPS	254
GLOVER MULTI PURPOSE VASCULAR CLAMPS	274
GLOCK RIB SHEAR	383
GOSLET RETRACTOR	148
GOLDMAN SEPTUM DISPLACER	312
GOLDMAN-FOX SUPER CUT SCISSORS	93
GOLDMAN-FOX OPERATING SCISSORS T/C INSERT	88
GOOD BONE FILE / RASP	183
GOOD SCISSORS	45
GORMEY SUCTION TUBES	17
GOSSET ABDOMINAL RETRACTORS	158
GOSSET BLADDER RETRACTOR	366
GOSSET RETRACTOR	158
GRADE	194, 184, 187
GRADE OLLA FORCEPS	74
GRADE DRESSING FORCEPS	72
GRADE FIXATION FORCEPS	72
GRADE FORCEPS	72
GRADE TONGUE & DRESSING FORCEPS	88
GRADE TISSUE FORCEPS	79
GRAHAM NERVE DURA HOOK	343
GRASPING BRONCHO DESCOPRAGOSCOPY FORCEPS	335
GRASPING FORCEPS FLEXIBLE SHAFT	294
GRAVE VAGINAL SPECULUM	369
GRAVE VAGINAL SPECULUM LEEP / LIETZ	370
GRAVE & VERON SPECULUMS	370
GREEN-ARMYtage UTERINE ELEVATING FORCEPS	484
GRIMMOND NERVE HOOK	344
GROSS EAR CURETTE	368
GROSS EAR SPOON	369
GROSS MAIER DRESSING FORCEPS	88, 87
GROSS MAIER DRESSING SPONGE & DRESSING FORCEPS	88, 87
GROSSMANN AREOLA MARKER	182
GROSSER AURAL SPECULA EAR SPECULUM	366
GROSSER COMBINATION KNIFE HANDLE / PERICHOONDRIUM ELEVATOR ET	185
GROSSER EAR SPECULUM	365
GRUENWALD FORCEPS	88
GRUENWALD TISSUE FORCEPS	88
GUBSCH AUFRICHT NASAL RETRACTOR	171
GUBSCH CARTILAGE CRUSHER	179
GUM & OPERATING SCISSORS	45
GUMCO CIRCUMCISION CLAMP	364
GUTHRIE HOOKLET	137
GUTMANN SECRETIONS SCOOP	387
GUYTON URETHRAL BOUGIES AND DILATING SOUND	383
GUYTON URETHRAL CATHETERS	383
GWILLIAM UTERUS HOLDING FORCEPS	387
H	
HAASE REDUCTION FORCEPS	228
HABERER STOMACH INTESTINAL TRIN CLAMP FORCEPS	246
HAEMOSTATIC FORCEPS 19,20,21,22,23,24,25,26,27,28,29,30,31,32,34,35,36,37,38,39,40,41	189
HAEMOSTATIC TISSUE FORCEPS	88
HAGHT RIB RETRACTOR	389
HAIJCK BALLENGER SEPTUM ELEVATOR	185
HAIJCK HAMMER	182
HAIJCK MALLETS	181
HAIJCK RONGEUR PUNCH	321
HAIJCK-CLAUS RONGEUR PUNCH	321
HAIJCK-KOFLER RONGEUR PUNCH	321
HAKANSSON BONE RONGEUR	378
HALLE BONE CURETTE	185
HALLE NERVE DURA HOOK	342
HALLE SCISSORS	45
HALLE SEPTUM ELEVATOR	185
HALDORN ILLUMINATION	82
HALSEY NEEDLE HOLDERS	185
HALSEY NEEDLE HOLDERS T/C	114
HALSTED HAEMOSTATIC FINE POINT FORCEPS	81
HALSTED HAEMOSTATIC FORCEPS	81, 85
HALSTED-MONKSURO-HAEMOSTATIC FORCEPS	79
HAND DRILLS	328, 329, 330
HANK DOUBLE ENDED	389
HANK UTERINE DILATORS & SET	389
HANK UTERINE DILATORS, DOUBLE-ENDED	389
HARD WIRE CUTTER CUTS	319
HARDY NEURO-MICRO DISSECTOR	345
HARDY-NUDEY SPECULUM	378
HARRINGTON EXTRA DEEP RETRACTOR	148
HARRINGTON RETRACTOR	148
HARRINGTON RETRACTORS WITH FIBER OPTIC	179
HARRINGTON SPINAL ELEVATOR	194
HARRINGTON SPANCHNIC RETRACTOR	188
HARRIS CAPSULE LIGATURE ANGLED SUTURE FORCEPS	309
HARTMAN EAR FORCEPS	323
HARTMANN BONE RONGEUR	371
HARTMANN CHEEK RETRACTOR	324
HARTMANN EAR FORCEPS	323
HARTMANN EAR POLYPUUS FORCEPS	318
HARTMANN EAR SPECULUM	399
HARTMANN EUSTACHIAN CATHETERS	38, 399
HARTMANN NASAL CUTTING FORCEPS	329
HARTMANN NASAL POLYPUUS AND SEPTUM FORCEPS	317
HARTMANN NASAL SPECULUM	383

DESCRIPTION	PAGE#
HARTMANN TONSEL GUELLOTINES & PUNCH FORCEPS	316
HARTMANN TUNING FORK	299,299
HARTMANN TUNING FORKS SET	299
HARTMANN, CUSTODIAN CATHETERS	39
HARTMANN-HALLE NASAL SPECULUM	323
HARTMANN-HOFFMANN EAR FORCEPS	333
HARTMANN-NOTES EAR FORCEPS	333
HARTMANN-WEINGARTNER EAR FORCEPS	333
HARTMANN-WULSTEIN EAR FORCEPS	333
HAWKIN AMBULER DILATORS	399
HAYES HAND RETRACTOR	287
HAYES SHROUD ANATOMICAL FORCEPS	344
HEANEY / BALLANTINE HAEMOSTATIC FORCEPS	86
HEANEY / BEZAK HAEMOSTATIC FORCEPS	87
HEANEY ATRAUMATIC HYSTERECTOMY FORCEPS	91
HEANEY HAEMOSTATIC FORCEPS	88
HEANEY MODIE HAEMOSTATIC FORCEPS	88
HEANEY NEEDLE HOLDERS	104
HEANEY UTERINE HOLDING FORCEPS	387
HEANEY-GYNE NEEDLE HOLDERS TC	117
HEANEY-KANTER HAEMOSTATIC FORCEPS	88
HEATH MALLETS	192
HEATH VASCULAR SCISSORS	42
HEALY-WRIGHT	192
HEGAR DOUBLE ENDED DILATORS	399
HEGAR UTERINE DILATOR	399,399
HEGAR UTERINE DILATOR, DOUBLE-ENDED	399
HEGAR UTERINE DILATORS 3 SET W/ROLL	399
HEDIGMANN-OSBORN VASCULAR SCISSORS	41
HEDIGMANN TISSUE FORCEPS	75
HEPPEZ, BRAIN SPATULA	341
HEMING KIDNEY STONE FORCEPS	326
HEISS RETRACTOR	199
HEISTER MOUTH GAG	326
HELPERICH-BIER EAR	182
HEMORRHOIDAL LIGATOR-SUCTION	393
HEINE TONSEL DISSECTOR	312
HEINE PLASTER CAST SPREADER	94
HEINRICH WEIGHTED VAGINAL SPECULUM	377
HEPP-SCHIEDL MICRO NEEDLE HOLDER	118
HERBERT MALLETS	192
HERNIA DIRECTOR, VASECTOMY FORCEPS, CLAMP & BLADDER RETRACTOR	367
HERICK HAEMOSTATIC FORCEPS	86
HERTZLER RETRACTOR	138
HERTZLER SID RETRACTORS	281
HERZ TENSION SPRING FORCEPS	88
HERZFELD RETRACTOR	132
HES HANDLE OSTECTOME	187
HEXAGONAL HEAD	238
HEY GROVES BONE HOLDING FORCEPS	323
HEYMANN NASAL DRESSING FORCEPS	318
HEYMANN SCISSORS	44
HEYMANN-KNIGHT NASAL, POLYPUS AND SEPTUM FORCEPS	317
HEYWOOD-SMITH SPONGE FORCEPS	96
HEYWOOD-SMITH POLYPUS GRASPING FORCEPS	341
HEYWOOD-SMITH SPONGE & DRESSING FORCEPS	189
HESS	188
HESS CHISEL	188
HESS CHISEL / OSTECTOMES	188
HESS CHISEL ENDOSCOPIC	188
HESS GOUGE	188
HESS GOUGE ENDOSCOPIC	188
HESS OSTECTOME	188
HESS OSTECTOMES ENDOSCOPIC	188
HESS RETRACTOR	398
HILL FERGUSON RECTAL RETRACTORS	148
HIRSCHMANN ANGIOSCOPE INTESTINAL RECTAL SPECULUM	352
HIRSCHMANN INTESTINAL RECTAL SPECULUM	351
HORN FORCEPS	68
HORN NERVE DURA HOOK	343
HORN PERIOSTEAL ELEVATOR	353,354
HORNMAN BONE ELEVATOR	359
HORNMAN BONE LEVER	367
HORNMAN LONG SHANK RETRACTOR	287
HORNMAN RETRACTOR	287
HORNMAN-WILLIGER RETRACTOR	288
HORN OSTECTOME	188,188
HOLDING & FOLDING FORCEPS	285
HOLDING & FOLDING FORCEPS FOR ACRYLIC LENSES	285,286
HOLE PRODUCTION CANNULA	423
HOLLNBERG INSTRUMENTS	425,426,427,428,429,430,431,432
HOLLNER NERVE ROOT RETRACTOR	342
HOOKLET & SON HOOKS	127,128
HOOKLET BUTTONED EAR LOOPS - HOOKS	388
HOOKLET EAR LOOPS - HOOKS	388
HOOKLETS RETRACTORS	128,128,130,131,132
HORNMAN IMPLANT TROCAR SET	368
HORSLEY BONE CUTTING RONGEURS FORCEPS	347
HORSLEY DURA DISSECTOR	344
HOUSE SUCTION TUBES	18
HOUEL RETRACTOR	152
HONNARTH PERIOSTEAL ELEVATOR	352
HONNARTH SEPTUM ELEVATOR	163
HUBER RETRACTOR	332
HUBSON, BRACE HAND DRILL	332
HUDSON BRACE	329,330
HUDSON CORABELLAR EXTENSION	336
HUDSON TISSUE & DRESSING FORCEPS	78

DESCRIPTION	PAGE#
HULKA-KENYICK UTERINE ELEVATING & MANIPULATING FORCEPS	357
HUNNY DERMATOMES	32
HUMERAL HEAD RETRACTOR	386
HUNT FORCEPS	68
HUNT TUMOR-LAND VESSEL FORCEPS	67
HUNTER FORCEPS	75
HUNTER UTERINE HOLDING FORCEPS	387
HURD TONSEL DISSECTOR	312
HURON HAND DRILL BIT	235
I	
IBINOCLAST DISSECTOR	183
IMPROVED MALTZ RASP	183
INDO BOX ROUND	429
INDO BOX WITH SILVER FRAME	427
INCE LAMINA SPREADER	237
INCE RETRACTOR	238,237
INITIAL INCISION RETRACTOR	169
INSERT DRILL SLEEVE	237
INSTRUMENT SOILER	426
INSTRUMENT SOILER ELECTRIC	426
INSTRUMENT SOILER WITH STAND	426
INSTRUMENT BOX	425
INSTRUMENT TRAY	425
INSTRUMENT TRAY WITH COVER	425
INSTRUMENT TRAY WITHOUT COVER	427
INSTRUMENTS CASSETTE 5, 7, 11 PEICES CASSETTE	427
INSTRUMENTS FOR ORAL OPENING	338
INTESTINAL & TISSUE GRASPING FORCEPS	338,339,340,341,342,343
INTESTINAL CLAMPS	343,344,346,349
INTESTINAL RECTAL SPECULA	350,351,352,354
INTRA ORAL RETRACTOR	178
INTRACARDIAC NEEDLE HOLDERS	198
INTRACARDIAC NEEDLE HOLDERS TC	191
IOL HOLDING FORCEPS	388
IOWA TENACULUM FORCEPS	398
IOWA SUCTION TUBE	39
IRS FORCEPS	83
IRS SCISSORS	48,288
IRS SON HOOKS	385
IRS SUPER CUT SCISSORS	85
IRS TISSUE FORCEPS	83
ISIP GRASPING FORCEPS	382
IVES-FANSLER ANGIOSCOPE INTESTINAL RECTAL SPECULUM	362
IVES-FANSLER RECTAL SPECULUM	360
J	
JADOMA MICRO NEEDLE HOLDER	119
JACKSON BURROWS RETRACTOR	187
JACKSON INTERVERTEBRAL DISC RONGEURS	249
JACKSON LARYNGEAL FORCEPS	328
JACKSON RETRACTOR	373
JACKSON-BURROWS TISSUE & DRESSING FORCEPS	68
JACOB'S CRICK	329
JACOBS	329
JACOBS UTERINE VULSELLUM FORCEPS	389
JACOBSON NEEDLE HOLDERS	183
JACOBSON NEEDLE HOLDERS TC	112,113
JACOBSON NEURO-MICRO DISSECTOR	245
JAEGER EYE KNIVES	283
JAEGER LID PLATE	283
JAMESON CALIPER CHROME	384
JAMESON CALIPER	12
JAMESON NEEDLE HOLDERS	183
JANSEN BONE RONGEUR	212
JANSEN CURETTE	188
JANSEN DRESSING FORCEPS	318
JANSEN EAR CURETTE	68
JANSEN FORCEPS	68
JANSEN RETRACTOR	152
JARVIS FILE FORCEPS	383
JASEN BONE RONGEUR	212
JEFFERSON TISSUE & DRESSING FORCEPS	70
JENNINGS MOUTH GAG	328
JEWELLER TYPE, DISSECTING FORCEPS	73
JOHNS-HOPKINS (POTTS BOOF) RB CONTRACTORS	377
JOHNSON NEEDLE HOLDERS	185
JOHNSON PROCTERIC NEED & HOLDER	399
JOLL (FRIEDMAN) THYROID- AND VEGINAL RETRACTOR	137
JOLL THYROID SELF RETAINING FORCEPS	282
JONES / PERFORATING TOWEL FORCEPS	83
JONES-MARTIN TOWEL CLAMP	83
JOPSON-HORNE COTTON APPLICATOR	32
JOSEPH BONE SAW / RASP	182
JOSEPH BANNING SEPTUM RASPARTORY	168
JOSEPH NASAL KNIFE	362
JOSEPH NASAL SAW	172,212
JOSEPH OPERATING SCISSORS TC INSERT	89
JOSEPH OPERATING, DISSECTING SCISSORS	39
JOSEPH RASP	212
JOSEPH SEPTUM ELEVATORS, RASPARTORY	311
JOSEPH-MASSIMO SEPTUM ELEVATORS RASPARTORY	311
JUDD MASSON BLADDER RETRACTOR	366
JUDICIALIS TISSUE FORCEPS	338
JULIAN NEEDLE HOLDERS TC	117
JURASE LARYNGEAL POLYPUS FORCEPS	337
K	
KALLMORGEN & RETRACTOR	374

DESCRIPTION	PAGE#
KALLMORGEN SPECULUM	374
KALLMORGEN SPECULUM & RETRACTOR	374
KALT NEEDLE HOLDERS	116,288
KALT NEEDLE HOLDERS TC	125
KANADISCHES MODELL MENISCOTOMY KNIFE	365
KANE OBSTETRICAL FORCEPS	464
KAYE BIRD ROUND SCALPEL HANDLE	35
KAYE-MILLARD RETRACTOR	147
KEITH ABDOMINAL NEEDLE	125
KELLY HAEMOSTATIC FORCEPS	75
KELLY INTESTINAL RECTAL SPECULUM	351
KELLY OPERATING DISSECTING SCISSORS TC INSERT	88
KELLY OPERATING, DISSECTING SCISSORS	33
KELLY PROCTOSCOPE INTESTINAL RECTAL SPECULUM	352
KELLY RETRACTORS	185,186,189
KELLY SPONGE & DRESSING FORCEPS	168
KERR BONE HOLDING FORCEPS	323
KERRISON BONE CAR ROMBOUR	321
KERRISON CERVICAL ROMBOUR	323
KERRISON ROMBOUR	355,356,357,358
KEVORKIAN BIPSY AND SPECIMEN FORCEPS	388
KEVORKIAN ENDOCERVICAL CURETTES	388,389
KEVORKIAN FLUSHING CURETTES	388
KEVORKIAN YOUNG BIPSY FORCEPS	381
KEY HANDLE	329
KEY HERMA DIRECTOR	367
KEY PERIOSTEAL ELEVATOR	203,264
KIDNEY STONE FORCEPS	355,356,357
KIDNEY TRAY (GERMAN PATTERN)	438
KIDNEY TRAY WITH COVER	438
KILLAND OBSTETRICAL FORCEPS	468
KILLAND-LUKARY OBSTETRICAL FORCEPS	468
KILIAN SEPTUM GOUGE	187
KILIAN-CLAUS SEPTUM GOUGE	187
KILIAN LARYNGOTOMY SCISSORS	323
KILIAN NASAL SPECULUM	384
KILIAN NASAL SPECULUM WITH FIBER	173
KILIAN NASAL SPECULUM WITH FIBER OPTICS ILLUMINATION	174
KILIAN PROSES	33
KILIAN SEPTUM ELEVATOR	185
KILIAN SEPTUM SPECULUM	384
KILIAN, EUSTACHIAN CATHETERS	38
KILNER HOOK	127
KILNER NEEDLE HOLDERS	165
KILNER NEEDLE HOLDERS TC	162
KILNER-DOUGHTY MOUTH GAG	327
KILNER-DOUGHTY MOUTH GAG HANDLE	327
KILNER-DOUGHTY MOUTH GAG SET WITH 3 BLADES COMPLETE	327
KIRK BALLETS	181
KIRSCHNER EXTENSION BOWS	233
KIRSCHNER RETRACTOR	161
KIRSCHNER WIRES & STEINMANN PWS CUTTER	218
KIRSCHNER WIRES	233
KIRSCHNER-BALFOUR RETRACTOR	161
KISTLER EAR CARTILAGE RASP	183
KLAPP RETRACTOR	135
KLEINERT-KUTZ ELEVATOR AND DISSECTOR	189
KLEINERT-KUTZ BONE CUTTING FORCEPS	218
KLEINERT-KUTZ BONE RASP	183
KLEINERT-KUTZ BONE ROMBOUR	218
KLEINERT-KUTZ SYNOVICTOMY ROMBOUR	218
KLEINERT-KUTZ TENDON RETRIEVER	265
KLINKUMBERLIN TUBING CLAMP	84
KNIFE HANDLE / (SMOOTH) FOR BLADES NOS. 50 AND 70	34
KRIGHT NASAL POLYPUUS AND SEPTUM FORCEPS	317
KNOXES PLASTER SCISSORS	52
KRUTSON URETHROGRAPHIE-INSTRUMENTS	384
KOCHER GOITRE EMULSATOR	328
KOCHER HAEMOSTATIC FORCEPS	83
KOCHER HAEMOSTATIC FORCEPS STRONG PATTERN	83
KOCHER HOOKLET, RETRACTORS	136
KOCHER INTESTINAL FORCEPS CLAMPS	343,344
KOCHER RETRACTOR	133,134,136
KOCHER-LANGENBECK RETRACTOR	137
KOCHER-KOCHNER HAEMOSTATIC FORCEPS	84
KOCHER'S BLADDER RETRACTOR	367
KOCHER-BALGREN RETRACTOR	136
KOCHER RETRACTOR	134,135
KOGAN - MOOF SPECULUM	372
KOGAN ENDOCERVICAL SPATULA	373
KOGAN SPECULUM	372
KOLBEL SOFT TISSUE RETRACTOR	185
KOMPLETT	61
KONIG ELEVATOR	382
KONIG RETRACTOR	133
KONIG REVERDIN NEEDLES	122
KORTE-WAGNER RETRACTOR	134
KOTZUR CANNULAS	414
KRATZ - BARRACLOUGH WIRE SPECULUM	394
KRAUS -VDSSE NASAL POLYPUUS SNARES	361
KRAUS -WELDE NASAL POLYPUUS SNARES	361
KRAUS EAR POLYPUUS SNARES	361
KRAUS NASAL POLYPUUS SNARES	361
KRAUS, TROCAR	18
KRISTELLER SPECULUM	371
KRISTELLER RETRACTOR	371
KRISTELLER SPECULUM & RETRACTOR	371
KRISTELLER SPECULUM TAPERED, FOR VIRGINS	371

DESCRIPTION	PAGE#
KROENCKER NEEDLE	123
KUEHNE OILA FORCEPS	74
K-YANG EXTRACTION PLIERS	210
L	
LA FORDE ADOXTOME PERFORATED	318
LA FORDE ADOXTOME UNPERFORATED	318
LABORDE TRACHEA DILATOR 3 PRONG	321
LACRYMAL DILATOR	282
LACRYMAL PROBES	282
LAHEY (SWEET) HAEMOSTATIC FORCEPS	87
LAHEY GOITER RETRACTOR	184
LAHEY GOITRE GRASPING FORCEPS	184
LAHEY NERVE DURA HOOK RETRACTOR	343
LAHEY RETRACTOR	185
LAMBERT-LOWMAN BONE CLAMP	321
LAMBOTTE BONE HOLDING FORCEPS	324
LAMBOTTE ELEVATOR	321
LAMBOTTE OSTEOHOME	187
LAMBOTTE RETRACTORS	191
LAMNECTOMY PUNCHES	287, 288, 289, 291, 292, 293, 294, 295, 296, 297, 298, 299, 300
LAMNECTOMY RETRACTORS	192
LANCASTER EYE SPECULUM	181
LANCEY TIP	38
LANDAU SPECULUM	379
LANDAU TROCAR	18
LANDOLT DISSECTING SUCTION TUBES	87
LANDOLT FORCEPS	89
LANDOLT OPERATING	25
LANDON VAGINAL RETRACTOR	374,375
LANE BONE ELEVATOR	324
LANE BONE HOLDING FORCEPS	324
LANE BONE LEVER	321
LANE BONE PLATE HOLDING FORCEPS	325
LANE STOMACH INTESTINAL CLAMP FORCEPS	348
LANE TISSUE FORCEPS	64
LANE TISSUE GRASPING FORCEPS	242
LARGE BARRIAGE SCISSORS	58
LARGE TISSUE FORCEPS	75
LARGENBECK AMPUTATION	39
LARGENBECK BONE ELEVATOR	164
LARGENBECK BONE HOLDING FORCEPS	223
LARGENBECK DISSECTING KNIVES	39
LARGENBECK EAR CURETTE	388
LARGENBECK METACARPAL SAW	167
LARGENBECK NEEDLE HOLDERS TC	121
LARGENBECK PERIOSTEAL ELEVATOR	382
LARGENBECK PERIOSTEAL ELEVATOR	304,305
LARGENBECK POLYOUS GRASPING FORCEPS	383
LARGENBECK RETRACTOR	137,134
LARGE PIN CUTTER	329
LARRY PROSE AND GROOVED DIRECTOR	37
LARYNGEAL MIRRORS	328
LARYNGEAL MIRRORS HANDLE	328
LARYNGEAL MIRRORS WITH HANDLE	328
LARYNGEAL POLYPUUS FORCEPS	327
LARYNGOSCOPE BATTERY HANDLE FOR	85
LARYNGOSCOPE BATTERY HANDLE FOR ADULT	83,84
LARYNGOSCOPE BATTERY HANDLE FOR ADULT AA BATTERIES	85
LARYNGOSCOPE BATTERY HANDLE FOR ADULT C TYPE	85
LARYNGOSCOPE FLEXIBLE (MC-COY) CONVENTIONAL SET	85
LARYNGOSCOPE SET OF CONVENTIONAL MILLER	85
LARYNGOSCOPE	83,84,85,86
LASTER-BURCH SPECULUM	384
LATERAL VAGINAL RETRACTOR	371
LATERAL VAGINAL RETRACTOR BLUE COATED LEEP /LIEZT	371
LATERAL WALL RETRACTOR	371
LATHBURY-FARREL TRIANGULAR SERRATED END	83
LEAD HAND	289
LEDSCHNE STERNUM CHISEL	383
LEESCHWILKINSON BIPSY FORCEPS	381
LEESCHWILKINSON SUCTION SURESEY CURETTES	388
LEEDHAM TISSUE FORCEPS	83
LESLIE BLADDER RETRACTOR	367
LESLIE BLADDER SPATULA	368
LESLIE RETRACTOR	169
LEWELL BONE ROMBOUR	314,316
LEWELL ROMBOUR	314
LEWELL-STILLE BONE ROMBOUR	314
LELAND-JONES PERIPHERAL VASCULAR CLAMPS	305
LEMPERT BONE CURETTE	187
LEMPERT BONE ROMBOUR	313
LEMPERT SEPTUM ELEVATORS NASRATORY	315
LENG MANIPULATING HOOK	293
LENSE EXPRESSION	282
LENZE TISSUE FORCEPS	62
LESTER RETRACTOR	176
LEUR NEEDLE EXTENSION	281
LEVASSEUR BIRKILL FIBER	175
LEWIN PERFORATING BONE HOLDING FORCEPS	322
LEWIS HONAL SCREEN	313
LEWKOWITZ LITHOTOMY FORCEPS	305
LEXER CHISEL	185
LEXER GOUGE	184,185
LEXER GOUGE TUFFNEL HANDLE	185
LEXER MOOF CHISEL	185
LEXER MOOF DISTOTOME	185

DESCRIPTION	PAGE#
LEXER OPERATING SUPER CUT SCISSORS	55
LEXER OSTEOTOME	188
LEXER OSTEOTOME FLAT	188
LEYLA SELF-RETAINING BRAIN RETRACTOR	238,262
L-3 INTERVERTEBRAL DISC RONGEURS	348
LICHTENBERG NEEDLE HOLDER	118
LICHTENBERG NEEDLE HOLDERS T.C	121
LICHTWITZ ANTRUM TROCAR	15
LIEBERMAN SPECULUM	394
LIGATOR RUBBER RINGS IN PACKAGE OF 100 PIECES	383
LIGATURE NEEDLE	123
LIGATURE REVERSE NEEDLES	123
LIGATURE NEEDLES	124
LINDERMAN AMPUTATION SAW	182
LINK RONGEUR	258
LINK SIMPLECTAN KERRISON RONGEUR	258
LINK BEATTY RONGEUR	258
LIPROSECTION CANNULA SET	410,426,431
LIPROSECTION CANNULA SET FOR NECK	428
LIPROSECTION CANNULAS	#13,#11,#12,#14,#15,#16,#17,#18,#19,#20,#21
LISTER BANDAGE PLASTER SCISSORS	81
LISTER BANDAGE PLASTER SCISSORS, T.C INSERT	88
LISTER BOUGIES	362
LISTER SINUS FORCEPS	88
LISTER-ECCENTRIC PLASTER SCISSORS	81
LISTER BONE CUTTING RONGEUR FORCEPS	216,217,218
LISTER DISSECTING KNIVES	38
LISTER KEY HOLE BONE CUTTING RONGEUR FORCEPS	217
LISTER-STILES BONE CUTTING RONGEUR FORCEPS	218
LITTAUER / LITTON BONE CUTTING RONGEUR FORCEPS	218
LITTAUER CELIA FORCEPS	74
LITTAUER EAR POLYPUS FORCEPS	318
LITTAUER NASAL POLYPUS AND SEPTUM FORCEPS	317
LITTAUER STITCH SCISSORS	43
LITTLE RETRACTOR	132
LITTLE WOOD TISSUE GRASPING FORCEPS	342
LOCKE PHALANXIAL FORCEPS	332
LOCKHART-BRIMBERY DIRECTORS	21
LOCKING Pliers	211
LOCKLIN DISSECTING SCISSORS	42
LOCKWOOD GRASP FORCEPS	341
LONG ANTERIOR KERRISON LAMINECTOMY PUNCH	261
LONG CHROME HANDLE INTERSTITIAL RECTAL SPECULUM	382
LONG HAEMOSTATIC TISSUE FORCEPS	88
LONG OPERATING DISSECTING SCISSORS	35
LOPEZ-BRINK SUCTIION TUBES	17
LORENZ PLASTER SCISSORS	52
LORNA TOWEL FORCEPS	83
LOVE NERVE DURA HOOK RETRACTOR	243
LOVE-GRUYENALD INTERVERTEBRAL DISC RONGEURS	347,348
LOVELACE LUNG TRISME FORCEPS	343
LOWER HAEMOSTATIC FORCEPS	87
LOWMANN BONE CLAMP	321
LUBET-BARSON NASAL POLYPUS AND SEPTUM FORCEPS	317
LUC BASAL CUTTING FORCEPS	319
LUCAS I ENT DRESSING FORCEPS	67
LUCAS DRESSING FORCEPS	318
LUCAS EAR LOOPS - HOOKS	288
LUCAS HOOKLET & SKIN HOOKS	128
LUCAS BALLETS	181
LUCAS TISSUE & DRESSING FORCEPS	67
LUCAS TUNING FORK	389
LUCAS CHISEL	184
LUCAS CURETTE	199
LUCAS BOWIE	184
LUER BONE RONGEUR	211
LUER LOCK ADAPTER	14
LUER RETRACTOR	138
LUER SUCTION TUBE WORKING	18
LUER, TROCAR	14
LUER-KOERTS MODIF WITH MALLEABLE SHAFT	361
LUER-LOCK SUCTION & IRRIGATION CANNULA	19
LUER-STANDARD TRACHEA TUBES	331
LUER-STILLE BONE RONGEUR	215
LUTHEY-BECK NEEDLE HOLDERS T.C	121
LUNG SPATULAS, AORTIC DILATORS	278
LURMATSCHER TONGUE TAMPON PLUGGER	313
LURZ POLYOUS GRASPING FORCEPS	383
LURZ HEMORRHOIDAL SUCTION LIGATOR	383
M	
MACCOLLUM DINGMAN BREAST DISSECTOR	162,163
MACCOLLUM DINGMAN SUBMAMMARY DISSECTOR	162
MACPHAIL NEEDLE HOLDERS	158
MAGILL CATHETER INTUBATING FORCEP GOLD	91
MAGILL CATHETER INTUBATING FORCEPS	91
MAGILL SUCTION TUBE	78
MAINGOT UTERUS HOLDING FORCEPS	387
MALE CATHETERS CHAIR - METAL	382
MALIBAC NASAL RETRACTOR WITH FIBER OPTIC	137
MALLEABLE RETRACTOR	158
MALLEOLLAR BONE HOLDING FORCEPS	327
MAULET #8	182
MAULETS	191,192,193
MAULET LIGHTWEIGHT	182
MALONEY INTRA-OPERATIVE KERATOMETER, TITANIUM	294
MALTZ NASAL SAW	314
MALTZ RASP	363,313

DESCRIPTION	PAGE#
MANDIBULAR CHANNEL RETRACTOR	174
MANNERFELT HOOK	128
MANNERFELT HOOKLET RETRACTORS	123
MANNERFELT MODIF. BALLINGER	187
MANNERFELT LANGENBECK HOOK	128
MARBACH PLASTER SCISSORS	83
MARSHAMBERYERONGS RETRACTOR	182
MARWALDER BONE CUTTING RONGEUR FORCEPS	217
MARGUARIOT BONE RONGEUR	213
MARSCHER TONGUE GRASPING FORCEPS	328
MARTEL HAEMOSTATIC FORCEPS	85
MARTH CARTRIDGE BONE HOLDING CLAMP FORCEPS	225
MARTH NEEDLE HOLDER	113
MARTH NERVE ROOT RETRACTOR	242
MARTH TONGUE RETRACTOR, OBSTETRICAL FORCEPS	488
MARTH TONGUE SPATULA	325
MARTH UTERINE SOUND	384
MARTH VAGINAL SPECULA	378
MARTIN CURETTE	188
MARX BREAST RETRACTOR	188
MASING PEROSTEAL SEPTUM ELEVATORS	372
MASING SEPTUM ELEVATOR	165
MASS. GENERAL HOSPITAL NEEDLE HOLDERS	182
MASSON NEEDLE HOLDER	188
MASSON NEEDLE HOLDERS T.C	118
MASSON-LUTHEY NEEDLE HOLDERS	184
MATHO GOITRE GRASPING FORCEPS	388
MATHEU FOR CHILDREN AND WIDOWS	375
MATHEU FOR CHILDREN AND WIDOWS FITTING	375
MATHEU NEEDLE HOLDER T.C	120
MATHEU NEEDLE HOLDERS	188
MATHEU RECTAL SPECULUM	388
MATHEU RETRACTOR	130
MATHEU VAGINAL RETRACTOR	374
MATHEU VAGINAL SPECULUM	374
MATHEU-RYDER NEEDLE HOLDERS T.C	120
MATHEU-RYDER VASCULAR NEEDLE HOLDERS T.C	120
MATSON MEMORATORY KNIFE	288
MAUNDER MOUTH GAG	326
MAURER-COLLIN HIB SHEARS	284
MAYFIELD BONE RONGEUR	214
MAYO DISSECTING & GYNECOLOGICAL SCISSORS	38
MAYO DISSECTING & GYNECOLOGICAL SCISSORS T.C INSERT	58
MAYO ROCHESTER NEEDLE HOLDERS	188
MAYO SCISSORS, SUPER CUT PLUS T.C	170
MAYO UTERINE SOUND	384
MAYO VESSEL CLAMP	343
MAYO-BLANK GALL STONE FORCEPS	288
MAYO-COLLIN RETRACTOR	141
MAYO-HARRINGTON DISSECTING & GYNECOLOGICAL SCISSORS	38
MAYO-HEGAR NEEDLE HOLDERS	181
MAYO-HEGAR NEEDLE HOLDERS T.C	113
MAYO-INCHIE DISSECTING & GYNECOLOGICAL SCISSORS	38
MAYO-ROBSON INTESTINAL CLAMP	344
MAYO-ROBSON INTESTINAL FORCEPS CLAMPS	343
MAYO-STILES DISSECTING & GYNECOLOGICAL SCISSORS	38
MAYO-STILLE DISSECTING & GYNECOLOGICAL SCISSORS T.C INSERT	58
MC DONALD ELEVATORS	388
MC INDOE BONE CUTTING FORCEPS	215
MC INDOE BONE CUTTING RONGEUR FORCEPS	218
MC INDOE DRESSING FORCEPS	65
MC INDOE DRESSING FORCEPS T.C	75
MCGER LATERAL VAGINAL RETRACTOR	371
MCGRIMBY HEMORRHOID GRASPING FORCEPS	353
MCGRIMBY HEMORRHOIDAL LIGATOR	383
MCGRIMBY HEMORRHOIDAL LIGATOR FORCEPS	384
MCINNIS POLYURETIC BREAST INSTRUMENT	182
MC-INTOSH FIBER OPTIC LARYNGOSCOPE BLADE	83
MC-INTOSH FIBER OPTIC LARYNGOSCOPE SET	83
MC-INTOSH FIBER OPTIC LARYNGOSCOPE SET HALOGEN ILLUMINATION	83
MC-INTOSH LARYNGOSCOPE	83,84,85
MC-INTOSH LARYNGOSCOPE CONVENTIONAL	85
MC-INTOSH LARYNGOSCOPE SET	83,84
MCKENZIE BRAN CLIP RACK	240
MCKENZIE CLIP APPLYING FORCEPS	288
MCKENZIE HAND DREL BIT	235
MCKENZIE INSTRUMENTS	288
MCLEAR OBSTETRICAL FORCEPS	488
MCLVOR MOUTH GAG COMPLETE SET	328
MCLVOR MOUTH GAG HANDLE	328
MCPHERSON - YAMMAD	288
MCPHERSON FORCEPS	288,287
MCPHERSON NEEDLE HOLDER	288
MEAD BONE RONGEUR	213
MEAD MALLET	182
MEASURING GAUGE	234
MEASURING INSTRUMENTS	13
MEASURING JIG	428
MEDIAL HAMUS RETRACTOR	174
MEDICINE CUP GRADUATED	428
MEMORIAL HEAD EXTRACTOR	228
MENISCIOTOMY KNIFE	288
MENISCUS CLAMP	322
MERCEDES CANNULAS	414
MESH BASKET	433
MESH CASSETTES, 3 PIECES, 7 PIECES, 18 PIECES, 18PIECES & 20 PIECES	433
MESH TRAYS 68 PCS	433
MESH TRAYS 87 PCS	432

DESCRIPTION	PAGE#
MESH TRAYS 16 PCS	432
MESH TRAYS 25 PCS	432
MESH TRAYS	432
METZENBAUM NEEDLE HOLDERS	188
METZENBAUM OPERATING SCISSORS T/C INSERT	37
METZENBAUM OPERATING, DISSECTING SCISSORS	37
METZENBAUM-FIND OPERATING SCISSORS T/C INSERT	37
METZENBAUM-FIND SCISSORS	38
METZENBAUM-NELSON OPERATING SCISSORS T/C INSERT	37
METZENBAUM-NELSON SCISSORS	38
MEYERSONG FINGER RETRACTOR	138
METZERS RETRACTOR	199,199,200
MICHEL CLIPS	76
MICHEL FORCEPS	76
MICHEL MOVABLE MIRROR	339
MICHEL REVERSION NEEDLES	122
MICHEL TISSUE FORCEPS	76
MICHELE TREPINE	239
MICRO NEEDLE HOLDER	289
MICRO ADSON TISSUE & DRESSING FORCEPS T/C	77
MICRO ADSON TISSUE FORCEPS T/C	77
MICRO ALLIGATOR	334
MICRO ALLIGATOR SCISSORS	334
MICRO CUP FORCEPS	249
MICRO ELECTOR KERRISON LAMINECTOMY RONGEURS	251,253
MICRO FAT INJECTION CANNULAS SET	427
MICRO INCISION FORCEPS	289
MICRO INCISION SCISSORS	289
MICRO INSTRUMENTS FOR LARYNGEAL BRONCHO OESOPHAGOSCOPY	334,335,338
MICRO NEEDLE HOLDERS	119,119,289
MICRO NEEDLE TISSUE FORCEPS T/C	76
MICRO RASP	183
MICRO RYDER NEEDLE HOLDERS	187
MICRO RYDER NEEDLE HOLDERS T/C	111
MICRO SCISSORS	46,49,56,288
MICRO TYING FORCEPS	67
MICRO-ADSON TISSUE & DRESSING FORCEPS	76
MICRO-ADSON-BERMER TISSUE & DRESSING FORCEPS	76
MICROVASCULAR NEEDLE HOLDERS	186
MICROVASCULAR NEEDLE HOLDERS T/C	111
MIDDLEBORFF RETRACTOR	134
MIDDLETON-JANSEN SEPTUM FORCEPS	333
MIDFACE FACIAL DISSECTOR	163
MIRLUCZ HAEMOSTATIC TISSUE FORCEPS	84,86
MIRLUCZ RETRACTOR	145,146
MILLER ALVEOLARY FILE	183
MILLER RASP	184
MILLER RETRACTOR	128
MILLER-COLUMBY BONE FILE	183
MILLIGAN DURA DISSECTOR	242
MILLIGAN RETRACTOR	189
MILIM BLADDER NECK SPREADER	362
MILIM BLADDER RETRACTOR	368
MILIM LIGATURE CARRYING FORCEPS ANGULAR	359
MILIM PROSTECTOMY FORCEPS	369
MILIM SECTION TUBE	367
MILIM YULSULUM FORCEPS	368
MINI - NOVAK ASPIRATING CURETTE	387
MINI - TISCHLER BIOPSY AND SPECIMEN FORCEPS	389
MINI DRILL SLEEVE	238
MINI LEXER CHISEL	188
MINI LEXER OSTEOTOME	188
MINI NON ROTATING	341
MINI OPHTHALMO SCOPRE	79
MINI ROTATING	341
MINI-HOHMANN BONE ELEVATOR	287
MINI-LAMBOTTE OSTEOTOME	187
MINI-ROUX RETRACTOR	148
MIXER FORCEPS, LEE MODIF	88
MIXER GALL STONE FORCEPS	88
MIXER HAEMOSTATIC GALL DUCT FORCEPS	87
MIXER OPHALMOUSSEY HAEMOSTATIC FORCEPS	88
MOD. BORN SCISSORS	45
MOD. MARTIN DRESSING FORCEPS	61
MOD. MICHEL FORCEPS	76
MOD. USA. DRESSING FORCEPS	61
MOD. USA. TISSUE FORCEPS	61
MOD. WEN NASAL SPECULUM	385
MODEL USA CART SPREADER PLASTER	54
MODELL PROCCLO ROUND SERRATED	33
MODELL PROCCLO TRIANGULAR SERRATED END	33
MODIFIED-USA PLASTER SCISSORS	53
MOELTGEN FLEXOMETER	
MOGEN CIRCUMCISION CLAMP	384
MOLLISON RETRACTOR	189
MOLT MOUTHGAG	326
MORSE DRILL AND BIT SET COMPLETE	328
MORSEFIELD FORCEPS	385
MORSON PROCTOSCOPE INTESTINAL RECTAL SPECULUM	392
MORRIS RETRACTOR	148
MORSE STERNAL RETRACTOR	278
MORSE-FARMLOD STERNAL RETRACTOR	288
MORTISING CHISEL	339
MORQUITO HAEMOSTATIC FORCEPS	78
MOUTH GAGS	326,327,328
MOUTH MIRRORS HEAD	96
MOYNIHAN GALL DUCT CLATOR	96
MOYNIHAN HAEMOSTATIC FORCEPS	83

DESCRIPTION	PAGE#
MULTI PURPOSE VASCULAR CLAMPS	372,373,374,376
MURPHY RETRACTORS	121
MUSEUX TENACULUM FORCEPS	388
MUSEUX TONSIL HOLDING FORCEPS	329
MYOMA INSTRUMENTS, FISTULA HOOKS	394
MYRTLE LEAF PROBE	33
N	
NABATOFF CABLE	283
NABATOFF HANDLE	283
NABATOFF METAL CASE	283
NABATOFF METAL CLIVE	283
NABATOFF METAL PROBE	283
NABATOFF PROBE TIP IN PLASTIC	283
NABATOFF VARICOSE VEIN STRAPPER	355
NAGELE OBSTETRICAL FORCEPS	487
NAGELE OBSTETRICAL	484
NAGAHARA CROPPER	280
NAGASA AURICULAR SEPTUM ELEVATOR	185
NAIL EXTRACTING FORCEPS	399
NAIL EXTRACTOR	
NAIL NIPPERS	47
NAIL RASP	183
NAIL SCISSORS	47
NAIL SPLITTING FORCEPS	399
NASAL CUTTING FORCEPS	329
NASAL KNIVES	399
NASAL POLYPUS & NASAL DRESSING FORCEPS	319
NASAL POLYPUS AND SEPTUM FORCEPS	317
NASAL POLYPUS SHARS	381
NASAL SAWS	313,314
NASAL SPECULA	382,383,384,384,388
NAUGHTON MORGAN NEEDLE HOLDERS	183
NECK CANNULAS	413
NEEDLE HOLDER	387
NEEDLE CASE	427,429
NEEDLE HOLDERS (SCHWED. MODEL)	184
NEEDLE HOLDERS	101,102,104-121
NEEDLE NOSE FLIERS	398,399
NEEDLE-NOSE LOCKING FLIERS	311
NEFF MENISCOTOMY KNIFE	288
NEGUS HAEMOSTATIC FORCEPS	83
NEGUS MOUTH GAG HANDLE	327
NEGUS MOUTH GAG COMPLETE SET	327
NEVERT NEEDLE HOLDERS	185
NEVERT NEEDLE HOLDERS T/C	117
NEVERT-ANDERSON OSTEOTOME	189
NELATON DIRECTORS	21
NELATON PROBES & DIRECTORS	21
NELSON TISSUE FORCEPS	64
NELSON THORAC THORAX	14
NEONATAL VASCULAR CLAMPS	374
NERVE HOOKS - DURA HOOKS	243
NEUFELD HAMMER	181
NEURO-DUPPLER HAMMER	82
NEURO-MICRO DISSECTORS	343,388
NEUTRAL & LOAD DRILL GUIDE	331
NEW INSTRUMENTS DISSECTING SET	71
NEW ORLEANS NEEDLE HOLDERS	183
NEW ORLEANS NEEDLE HOLDERS T/C	111
NEW PORT RETRACTORS	371
NICHOLS WEIGHTED SPECULUM	378
NICHOLS-VAGINALWEIGHTED SPECULUM	378
NO SCALPEL WASECTOMY HAEMOSTAT FORCEPS	387
NO SCALPEL WASECTOMY RINGED FORCEPS CLAMPS	387
NOSE DRUM	389
NON-PERFORATING TOWEL FORCEPS	82
NOYOK & MORROW RETRACTOR	188
NORTHENT STITCHES SCISSORS	40
NOSE FLIERS	319
NOSE SPECULUM	384
NOTO SPONGE & DRESSING FORCEPS	189
NOYER WIGAN SPECULUMS	378
NOYAK ASPIRATING CURETTE	387
NOYAK SUCTION	388
NOYES MICRO SCISSORS	58,287
NOYES NASAL DRESSING FORCEPS	319
NOYES SCISSORS	89
NUSSBAUM INTESTINAL FORCEPS CLAMPS	345
NUSSBAUM STOMACH INTRERINAL TWIN CLAMP FORCEPS	345
NYLON CAP	182
NYLON CAPS LEFT & RIGHT	183
NYLON HEAD Mallet	181
O	
O'BRIEN NEEDLE HOLDERS T/C	119
O'BRIEN VASCULAR SCISSORS	42
O'SHAUGHNESSY HAEMOSTATIC FORCEPS	82
O'SULLIVAN - O'CONNOR VAGINAL RETRACTOR	179
O'SULLIVAN/O'CONNOR RETRACTOR	189
OBSTETRICAL FORCEPS	487,488
OBSTETRICAL	484
OBREGESER - FREEH	382
OBREGESER ALVEOLAR (WEDDUM TOOTH) RETRACTOR	173
OBREGESER BLADE OSTEOTOME	189
OBREGESER DIAMOND RETRACTOR	325
OBREGESER CHEEK RETRACTOR	324
OBREGESER CHIN RETRACTOR	174,328

DESCRIPTION	PAGE#
OSWEGESER ELEVATOR	106,262
OSWEGESER LIAC CRIST RETRACTOR	173
OSWEGESER MANDIBULAR CHANNEL RETRACTOR	174
OSWEGESER NASAL SPINE RETRACTOR	173,225
OSWEGESER NEEDLE	388
OSWEGESER OSTEOTOME	188
OSWEGESER RAMMUS RETRACTOR	328
OSWEGESER RIB RASPATORY	165
OSWEGESER SOFT TISSUE RETRACTOR	325
OSWEGESER FREEER ELEVATOR	188
OCHSNER DRESSING FORCEPS	65
OCHSNER FORCEPS	75
OCHSNER TROCAR THORAX	15
OCHSNER VASCULAR FORCEPS	388
OLDBERG INTERVERTEBRAL DISC RONGEURS	248
OLIVECRONA BRAIN SPATULA	341
OLIVECRONA DURA DISSECTOR	342
OLIVECRONA TODDING (DOCVILLE) CLIP FORCEPS	248
OLIVECRONA TRUSEMIANAL KNIFE	31
OLIVECRONA VASCULAR SCISSORS	44
OLIVECRONA WIRE SAW	238
OLIVER RETRACTOR	138
OLSEN-REIGAR NEEDLE HOLDERS	104
OLSEN-REIGAR NEEDLE HOLDERS T/C	112
OMBREDANNE MALLETS	182
OPERATING & DISSECTING SCISSORS	25, 27, 28, 29
OPERATING SCISSORS (FLAT PATTERN)	33
OPERATING SCISSORS	33, 34, 41
OPERATING SCISSORS T/C	99-99
OPERATING SCISSORS, S/S CVD, T/C INSERT	58
OPERATING SCISSORS, S/S STR, T/C INSERT	58
OPERATING SCISSORS, S/S STANDARD CVD, T/C INSERT	58
OPERATING SCISSORS, S/S STANDARD STR, T/C INSERT	58
OPERATING SCISSORS, S/S CVD, T/C INSERT	58
OPERATING SCISSORS, S/S STR, T/C INSERT	58
OPHTHALMOSCOPE	88
OPHTHALMOSCOPE HEAD	87, 88
OPTIC RETRACTOR FOR VERTICAL OSTECTOMIES	175
ORBITAL RIM DISSECTOR	184
ORINGER LIP AND CHEEK RETRACTOR	324
ORTHO MALLETS	182
ORTHOPAEDICS, TENDON STRIPPERS	288
ORTHOPEDIC MALLET	182
OSTEOTOME BLADES, INTERCHANGEABLE	184
OSTEOTOME ELEVATOR	282
OSTEOTOMES	184, 187
OTOSCOPE + OPHTHALMOSCOPE SET	88
OTOSCOPE HEAD	88, 88
P	
PACKER MOSQUITO FORCEPS	81
PAININGS BLADDER RETRACTOR	368
PAPER DRESSING FORCEPS	87
PARALLEL TARGET DEVICE	238
PARAMETRIUM FORCEPS, HYSTERECTOMY FORCEPS	388
PARAMETRIUM HAEMOSTATIC FORCEPS	88
PARAMETRIUM HYSTERECTOMY FORCEPS	388
PARHAM MARTIN BANDS	321
PARHAM-MARTIN BONE CLAMP	321
PARKER RETRACTOR	141
PARKER-LAMENBECK RETRACTOR	141
PARKER-MOTT RETRACTOR	141
PARTSCH CRIBEL	184
PARTSCH GOUGE	182
PARTSCH MALLETS	182
PASSOW BONE TAMPER	184
PATELLA BONE SAW	183
PATELLA MALLEOLAR FORCEPS	237
PAUL HOOKLET RETRACTORS	138
PAIR CRUSHING INTESTINAL CLAMP	348
PAIR REVERSON NEEDLES	132
PAIR-BABY CRUSHING INTESTINAL CLAMP	348
PEAN HAEMOSTATIC FORCEPS SLENDER TYPE	83
PEAPOG INTERVERTEBRAL DISC RONGEURS	254
PECK RAPE RETRACTOR	138
PEDERSON VAGINAL SPECULUM	378
PEDERSON VAGINAL SPECULUM LEAF / LIETZ	378
PEDERSON VIRGIN SPECULUMS	378
PEDIATRIC VASCULAR CLAMPS	278
PEERS-BERTMAN TOWEL FORCEPS	83
PEET SPLINTER FORCEPS	78
PELHAMM SPONGE FORCEPS	88, 89
PELTONEN COTTON APPLICATOR	32
PELVIC REDUCTION FORCEPS ASYMMETRIC	327
PELVIC REDUCTION FORCEPS	327
POLYMER, OBSTETRICAL FORCEPS	488
PENFIELD DURA DISSECTOR	245
PENFIELD ELEVATORS	288
PENN BREAST DISSECTOR	162
PENNINGTON (SEIZING HAEMOSTATIC FORCEPS)	85
PENNINGTON SEPTUM ELEVATORS RASPATORY	311
PENNINGTONS PERIOSTEAL ELEVATOR	283
PERCUSSION HAMMERS	82
PERCY AMPUTATION SHIELD	182
PERFORATED BASKETS	433
PERFORATED TRAY	428
PERIOSTEAL ELEVATORS	184, 186-204, 287
PERIOSTEAL ELEVATORS, MENISCIOTOMY KNIVES	385

DESCRIPTION	PAGE#
PERIOSTEAL ELEVATORS, SEPTUM ELEVATORS	312
PERIOSTEAL ELEVATORS, TAMPERS	184
PERIOSTEAL RASPATORIES	282
PERIOSTEAL SPREADER	184
PERIPHERAL VASCULAR CLAMPS	288, 270
PERRINS RETRACTOR	154
PERRINS	288
PETALAZZA OVUM CURETTE	485
PETRI PTERYGOID RETRACTOR WITH FIBER OPTIC	177
PHANUP HAEMOSTATIC TISSUE FORCEPS	88
PHENOLIC HANDLE MALLET	182
PHICE ANTRUM TROCAR	15
PILE FORCEPS	382
PIW CUTTER MEDIUM	228
PIW CUTTER SMALL	228
PIW PULLER W/ GROOVE T/C	328
PIARD ALUMINIUM STETHOSCOPE	81
PIARD WOODEN STETHOSCOPE	81
PIPER OBSTETRICAL FORCEPS	487
PIPER FORCEPS	88
PLASTER SAW ELECTROMIC POWER	228
PLASTER SCISSORS	81-83
PLASTER SHEARS	54
PLASTIC EAR CANNULAS	88
PLATE BENDER	232
PLATE BENDING PLIER	211
PLESTER BAUMENPLATT	78
PLESTER RETRACTOR	154
PLESTER SUCTION TUBES 17 CM	78
POLITZER EAR SPECULUM	285
POLYDUS GRASPING FORCEPS, ANATOMOSIS	245, 247, 248, 282
POLY SUCTION CANNULA	74
POTTS COAGULATION CLAMPS	287
POTTS LIGATURE FORCEPS	288
POTTS MULTI PURPOSE VASCULAR CLAMPS	272
POTTS MULTI PURPOSE VASCULAR CLAMPS	272
POTTS-SMITH DRESSING FORCEPS	81
POTTS-SMITH DRESSING FORCEPS T/C	78
POTTS-SMITH T/C DRESSING FORCEPS	78
POTTS-SMITH TISSUE FORCEPS	82
POTTS-SMITH VASCULAR SCISSORS	81
POZZI TENACULUM FORCEPS	388
PRATT ANTRUM CURETTE	278
PRATT HAEMOSTATIC FORCEPS	85
PRATT RECTAL SPECULUM	288
PRATT TENACULUM FORCEPS	388
PRATT UTERINE DILATORS & SET	388
PRATT UTERINE DILATORS, DOUBLE ENDED	388
PRESBYTERIAN TUBING CLAMP	94
PRESTON LOGAMENTUM FLAVUM FORCEPS	222
PRINCE SCISSORS	85
PROBE MYRTLE-SHAPED	73
PROBE WITH EYE	18, 21
PROBE, DOUBLE ENDED	73
PROBES AND DIRECTORS	71-73
PROFESSIONAL OTOSCOPE & OPHTHALMOLOGY SET	87
PROSTATIC RETRACTOR	388
PUNCH BRONCHO DESOPHOBOSCOPY FORCEPS	328
PUNCHES SPHENOID BONE	321
PUTTI RASP	182, 183
PUTTI BONE FILE	182
PUTTI BONE RASP	182
Q	
QUERWYN ELEVATOR	281
QUIRE EAR POLYPUS FORCEPS	178
R	
RABNER HAMMER	82
RAGNELL GAVE RETRACTOR	132
RALK DRAIL	228
RAMATHRODI TUBAL HOOK	372
RAMATHRODI UTERINE MANIPULATOR	372
RANSAY DISSECTING FORCEPS	84
RANSAY TISSUE FORCEPS	84
RANUS RETRACTOR	174
RANDALL KIDNEY STONE CLAMPS FORCEPS	388
RANDALL KIDNEY STONE FORCEPS	388
RANDALL SUCTION BIOPSY CURETTES	388
RANET APPLYS & REMOVING FORCEPS	248
RASPATORIES	188
RASPATORIES	188
RASPS WITH TUNGSTEN CARBIDE	213
RASPS, FILES	184
RAY BONE CURETTE	188
RAZOR BLADE BREAKER & HOLDER, STRAIGHT	28
RAZOR BLADE HOLDER & BREAKERS	28
RAZOR HOLLOW	82
RECAMER UTERINE CURETTE	481, 482
RECTAL BIOPSY FORCEPS	387
RECTUM VASECTOMY SET	388
RECTUM VASECTOMY SET OF 2 PCS	388
RECTUM VASECTOMY SET OF 3 PCS	388
RECTUM VASECTOMY SET OF 4 PCS	388
REDUCTION FORCEPS	327
REDUBERT SPICULOTIS RETRACTOR	322
REL BONE HOLDING FORCEPS	227
RELL BONE REDUCTION FORCEPS	328

DESCRIPTION	PAGE#
ROEHR BAR SYRINGE	298
ROEHR BAR SYRINGE RHEAD	298
ROPOSITION FORCEPS	327
ROPROCUSSION FREE Mallet	193
ROSSANO DRESSING FORCEPS T.C	78
ROSSANO INTESTINAL POLYOUS GRASPING FORCEPS	345
ROSECTION KNIFE	38
RETRACTOR, INSULATED BLADE	168
RETRACTORS & DRESSING FORCEPS	282
RETRACTORS	133-181, 174-177, 207, 225, 242, 332, 365
RETRACTORS INSTRUMENTS	173
RETRACTORS, VERN HOOK	147
ROUTHER LUAC CREST RETRACTOR	178
RYVERDIN NEEDLER	122, 123, 128, 129
RYVERDIN RETRACTOR	158
REYNOLDS OPERATING SCISSORS T/C INSERT	58
REYNOLDS TRANSAXILLARY BREAST DISSECTOR, PENETRATED,	162
RHEINSTADT FLUSHING CURETTES	288
RHINOPLASTY INSTRUMENTS	178-181
RHINOPLASTY RETRACTORS	173
RHINOPLASTY SET	178-181
RB CONTRACTORS	277
RB RETRACTORS	273-282
RB SHEAR	282
RB SHEARS, STERNUM CHISEL	283, 284
REBORN RETRACTOR	188
RICHARDSON EASTMAN RETRACTOR	138
RICHARDSON RETRACTOR	148, 149, 178
RICHARDSONKELLY RETRACTOR	147
RICHARDSON-EASTMAN RETRACTOR	148
RICHNAU HON MORSE EAR SPECULUM	288
RICHTER OPERATING, DISSECTING SCISSORS	38
RICHTER-HEATH FORCEPS	78
RICHERT SELF RETAINING BRAIN RETRACTOR	238
RIDGELY RETRACTOR	154
RIND CUTTER	288
RINGRESSOR	315, 316
RISKIN BONE RONGEUR	214
RITTER-HALLE FORNITAL SINUS DRUGGER	322
ROBERTS HAEMOSTATIC FORCEPS	88
ROBINSON'S KNIFE	288
ROCHARD RETRACTOR	168
ROCHESTER NEEDLE HOLDERS T/C	114
ROCHESTER-CARMALT HAEMOSTATIC FORCEPS	82-84
ROCHESTER-DCHREER HAEMOSTATIC FORCEPS	84
ROCHESTER-PEAR HAEMOSTATIC FORCEPS CURVED	84
ROCHESTER-PEAR HAEMOSTATIC FORCEPS STRAIGHT	84
ROD BENDER	232
ROEDER TOWEL FORCEPS	92
ROGERS PARAMETRIUM HYSTERECTOMY FORCEPS	388
ROGGE STERILIZING FORCEPS	424
ROLLET (BLAIR) HOOKLET RETRACTORS	128
ROLLET HOOK	127
ROLLET HOOKLET RETRACTORS	128
ROOSEVELT STOMACH INTESTINAL TRIN CLAMP FORCEPS	348
ROSE RETRACTOR	138
ROSEN BAR SPECULUM	298
ROSEN PHCO SPLITTER	292
ROSEN SUCTION TUBE	28
ROSENBLAND MOUTH BAG	326, 328
ROSS RETRACTOR	147
ROTTGEN-BUSKIN BONE RONGEUR	215
ROUYEDA CATHETERS	362
ROUND BEDSPAN	428
ROUND HORNLED SCALPEL HANDLE	28
ROUND SCALPEL HANDLE	28
ROUX RETRACTOR	148
ROUX-MAGNUS RETRACTOR	148
ROUX OSTEOTOME	188
ROUX SEPTAL MORSELLER FORCEPS	178
ROUX SEPTAL MORSELLER FORCEPS T.C.	178
ROUX SEPTUM FORCEPS	322
ROUX WIRE TWISTER NEEDLE HOLDERS T/C	117
ROUXY BONE CUTTING RONGEUR FORCEPS	217
RUSHIN RONGEUR	214
RUSHIN-LISTON BONE CUTTING RONGEUR FORCEPS	218
RUSHIN-MANI BONE RONGEUR	218
RUSSIAN-MODELL TISSUE FORCEPS	62
RYDEL BEPPER TURNING FORK	288
RYDER FRENCH EYE STANDARD MICRO NEEDLE HOLDERS T/C	113
RYDER NEEDLE HOLDERS	107
RYDER NEEDLE HOLDERS T/C	113

S

SACHS DURA DISSECTOR	244
SACHS NERVE ELEVATOR	198
SAENDER ABDOMIN FORCEPS	408
SAFE CANNULA SET	422
SAFETY SUPER CUT SCISSORS	88
SALER SCISSORS	44
SALDANHA SOLZ ABDOMINAL RETRACTOR	174
SALPHOGRAM	362
SAMB FORCEPS	67
SARROT HAEMOSTATIC FORCEPS	81
SARROT NEEDLE HOLDERS	102, 103
SARROT NEEDLE HOLDERS T/C	113
SATINSKY TANGENTIAL OCCLUSION FORCEPS	271
SAUERLEE AMPUTATION & RESECTION	32

DESCRIPTION	PAGE#
SAUERLEE SAW	162
SAUERBRUCH BONE RONGEUR	215
SAUERBRUCH RETRACTOR	142
SAUERBRUCH RID SHEARS	234
SAUERBRUCH-FREY RB SHEARS	282
SAW BLADE ONLY	200
SAWYER RETRACTORS	188
SAYRE PERIOSTEAL ELEVATOR	204
SCALER BOX	427
SCALER TRAY	427
SCALP ELEVATOR	194
SCALPEL 83P HANDLE	28
SCALPEL 83RD HANDLE	25
SCALPEL BLADES	27
SCALPEL GRIP	28
SCALPEL HANDLE #4 WITH ADJUSTABLE	25
SCALPEL HANDLE #4 WITH SCALE	24
SCALPEL HANDLE #7	24
SCALPEL HANDLE 1 LONG ANGLED 84A	24
SCALPEL HANDLE 3L LONG	24
SCALPEL HANDLE 4L LONG BLADE	24
SCALPEL HANDLE 84A	24
SCALPEL HANDLE DOUBLE ENDED #3, #4	24
SCALPEL HANDLE #3	24
SCALPEL HANDLE #4	24
SCALPEL HANDLES	24-26
SCALPEL KNIFE	28-29
SCALPEL PLASTIC HANDLE # 1	26
SCALPEL PLASTIC HANDLE # 1	26
SCALPEL PLASTIC HANDLE #8 BLADE	26
SCALPEL PLASTIC HANDLE	26
SCHAEDEL TOWEL FORCEPS	92
SCHAEDE BONE CURETTE	192
SCHAEDE DRAIN GRASPING FORCEPS	341
SCHERSACK SPECULUM	276
SCHNITZER HAEMOSTATIC TISSUE FORCEPS	88
SCHNICK DERMATOMES	32
SCHLESINGER CERICAL RONGEUR	232
SCHLESINGER INTERVERTEBRAL DISC RONGEURS	388
SCHMIDEN NEEDLE	122
SCHMIDEN-DECK NEEDLE	122
SCHNEDDRE RETRACTOR	132
SCHROEDER UTERINE SPOON	492
SCHROEDER BONE CURETTE	198
SCHROEDER FLUSHING CURETTES	288
SCHROEDER TENACULUM FORCEPS	188
SCHROEDER VULVELLUM TENACULUM FORCEPS	188
SCHROEDER-IPRAUR TENACULUM FORCEPS	188
SCHWARDT RB SHEARS	284
SCHUBERT BIOPSY FORCEPS	324
SCHUHNECHT RETRACTOR	152
SCHULTZE SALPINGOGRAPH	322
SCHULZE-BERGMANN INTERSTITIAL RECTAL SPECULUM	188
SCHULZACHER BIOPSY AND SPECIMEN FORCEPS	188
SCHULZACHER BIOPSY FORCEPS	324, 324
SCHULZACHER PLASTER SCISSORS	32
SCHULZACHER RB SHEARS	282
SCHULZACHER STERNUM SHEARS	282
SCHWARTZ CLIP APPLYING FORCEPS	240
SCHWARTZ VERHEL CLIP	240
SCHWARTZ NASAL SPECULUM	324
SCHWEMMER CHEEK RETRACTOR	176
SCISSORS	14, 288
SCLERAL PLUG FORCEPS	288
SCOVILLE BONE CURETTE	192
SCOVILLE NERVE RETRACTOR	208
SCOVILLE NERVE ROOT RETRACTOR	242
SCOVILLE-RICHTER RETRACTOR	158
SCREW DEPTH GAUGES	234
SCREW DRIVERS	238
SCUDDER INTESTINAL FORCEPS-CLAMPS	145
SCULPO BREAST RETRACTORS	198
SEBILAU PERIOSTEAL ELEVATOR	194
SEDLLOT ELEVATOR	200
SEIGOND BYOMA KNIFE	388
SEIGOND BYOMATOME	31
SEIGOND-LANDAU HAEMOSTATIC FORCEPS	88
SEIFFERT PROBES	23
SEITZ-GUM RETRACTOR	152
SELF RETAINING BRAIN RETRACTOR	238
SELF-RETAINING RETRACTORS	238
SELLHEM ORTHETICAL LEVER	498
SELLERS RB CONTRACTOR	277
SELVERSTONE INTERVERTEBRAL DISC RONGEURS	248
SENB BONE CUTTING RONGEUR FORCEPS	217
SENB BONE HOLDING FORCEPS	222, 225
SENB BONE RONGEUR	215
SENB PERIOSTEAL ELEVATOR	202
SENB RB SHEARS	282
SEMKEN DRESSING FORCEPS	91
SEMKEN TISSUE FORCEPS	78
SEMM ABDOMINAL RETRACTORS	181
SEMM VAGINAL SPECULUM	328
SENN RETRACTOR	131
SENN-GREEN RETRACTOR	132
SENNING NEEDLE HOLDERS	104
SENNING NEEDLE HOLDERS T/C (SCHWED MODEL)	111
SENN-MUELLER RETRACTOR	131

DESCRIPTION	PAGE#	DESCRIPTION	PAGE#
SEPTUM ELEVATORS - RASPATORIES	311,324,325	STANDARD DRESSING FORCEPS	67
SEPTUM FORCEPS	325	STANDARD DRESSING FORCEPS NARROW POINT	67
SEPTUM INSTRUMENTS	322	STANDARD DRESSING FORCEPS SERRATED	67
SEPTUM NEEDLE SECTION & BRIGATION CANNULA	79	STANDARD DRESSING FORCEPS T.C	78
SEQUESTRUM (MICROSE) BONE HOLDING FORCEPS	323	STANDARD NON ROTATING	341
SERRA GIGLI	182	STANDARD OPERATING SUPER CUT SCISSORS	55
SET SUGGESTIONS LIP/SECTION CANNULAE	413	STANDARD OPHTHALMOSCOPE	18
SEUDIN PLASTER SCISSORS	53	STANDARD OPHTHALMOSCOPE SET	69
SEYFFERT WYON SPECULUMS	370	STANDARD OTOSCOPE + OPHTHALMOSCOPE SET	69
SHARMAN ENDOMETRIAL MOPSY CURETTES	388	STANDARD OTOSCOPE SET	69
SHAVING MUG	430	STANDARD ROTATING	341
SHELA WITH FIBER OPTIC	175	STANDARD TISSUE FORCEPS	67
SHEENAN OSTIOTOME	180	STAUDE - MOORE TENACULUM FORCEPS	388
SHORT REVEREND NEEDLES	122	ST-CLAIR THOMSON NASAL SPECULUM	383
SHORTBENT STITCH SCISSORS	43	STELLBRINK BONE RONGEUR	313
SHOULDER PENETRATING GAUGE	187	STERILE SCALPEL BLADE SIZE # 10	27
SHOULDER PERCUSSION AWL	323	STERILE SCALPEL BLADE SIZE # 10A	27
SIDE CUTTER	230	STERILE SCALPEL BLADE SIZE # 11	27
SIDE PIN CUTTER	319	STERILE SCALPEL BLADE SIZE # 11P	27
SIDE WALL RETRACTORS	371	STERILE SCALPEL BLADE SIZE # 12	27
SIEGEL ROUND	25	STERILE SCALPEL BLADE SIZE # 13	27
SIEGEL ROUND SCALPEL HANDLE (S) WITH ADJUSTABLE	25	STERILE SCALPEL BLADE SIZE # 15	27
SIEGEL MAGNIFIER EAR SPECULUM COMPLETE SET	397	STERILE SCALPEL BLADE SIZE # 15A	27
SIEGEL MAGNIFIER OTOSCOPE	397	STERILE SCALPEL BLADE SIZE # 17	27
SIGMOID NYTCH RETRACTOR WITH FIBER OPTIC	177	STERILE SCALPEL BLADE SIZE # 18	27
SILVER DERMATOSES	32	STERILE SCALPEL BLADE SIZE # 20	27
SILVER RHINOPLASTIC CHESEL	188	STERILE SCALPEL BLADE SIZE # 21	27
SILVERSTEIN BREAST DISSECTOR	183	STERILE SCALPEL BLADE SIZE # 22	27
SIMON BONE CURETTE	186	STERILE SCALPEL BLADE SIZE # 23	27
SIMON DISSECTING KNIVES	30	STERILE SCALPEL BLADE SIZE # 24	27
SIMON FISTULA HOOK	398	STERILE SCALPEL BLADE SIZE # 25	27
SIMON VAGINAL RETRACTOR	375	STERILE SCALPEL BLADE SIZE # 26	27
SIMPSON - BRADY OBSTETRICAL FORCEPS	497	STERILE SCALPEL BLADE SIZE # 40	27
SIMPSON - LUKART OBSTETRICAL FORCEPS	497	STERILE SCALPEL BLADE SIZE # 6	27
SIMPSON OBSTETRICAL FORCEPS	497	STERILE SCALPEL BLADE SIZE # 6B	27
SIMPSON UTERINE SOUND	384	STERILE SCALPEL BLADE SIZE # 7B	27
SIMS DISSECTING & GYNEDOLOGICAL SCISSORS	60	STERILE SCALPEL BLADE SIZE # C11	27
SIMS HANDLE	399	STERILIZING BOXES (WITH SILICON PADS)	399
SIMS RECTAL SPECULUM	350	STERILIZING DRUMS	434
SIMS SPECULUM & RETRACTOR	373	STERILIZING FORCEPS	434
SIMS UTERINE CURETTES	489,492	STERNBERG LIP AND CHEEK RETRACTOR	324
SIMS UTERINE SOUND	384	STERNBERG RETRACTOR	133
SIMS-HAER SPONGE & DRESSING FORCEPS	99	STERNUM NEEDLE HOLDERS T.C	118
SIMS-SPECIAL UTERINE SOUND	384	STETHOSCOPES	67
SINGLEY-TUTTLE FORCEPS	65	STEVENS OPERATING SCISSORS T.C INSERT	59
SINUSKEY HOOK	394	STEVENS SCISSORS	47
SINUSKEY ILLIENS MANIPULATING HOOK	393	STEVENS TENOTOMY SUPER CUT SCISSORS	55
SINUSCOPY TROCAR	34	STEVENS TISSUE FORCEPS	73
SKONE TENACULUM FORCEPS	388	STEGELITZ FORCEPS WITH MEGALOPYING MIRRORS	73
SKIN POMO PLATE	32	STEDLITZ SPLINTER FORCEPS	78
SLOTTED HAMMER	230	STELLE	188,188
SLUDER-SALLENGER TONSIL GUILLOTINES & PUNCH FORCEPS	310	STELLE BONE RONGEUR	314
SLUDER-SALLENGER TONSIL GUILLOTINES & PUNCH FORCEPS HANDLE	310	STELLE CHESEL	188,188
SMELLIE OBSTETRICAL FORCEPS	494	STELLE GAUGE	188,188
SMELLIE RETRACTORS	395	STELLE HAEMOSTATIC FORCEPS	67
SMELLIE TENOTOMY KNIFE	395	STELLE OSTIOTOME	188,188
SMITH (MOD. USA) PLASTER SCISSORS	52	STELLE PATTERN DRILL SET	328
SMITH PETERSON	185	STELLE PLASTER SHEARS	34,328
SMITH PETERSON OSTIOTOME	185	STELLE-SARRAYA TISSUE FORCEPS	65
SMITH-SLUE INTERSTITIAL RECTAL SPECULUM	350	STELLE-WHEELLEY BONE CUTTING FORCEPS	318
SMITH-PETERSEN	188	STELLE-LEUR RONGEUR	315
SMITH-PETERSEN GAUGE	188	STELLE-LUSTON BONE CUTTING RONGEUR FORCEPS	317,318
SMITH-PETERSEN OSTIOTOME	188	STELLE-LUER SCALIN BUCK BILL RONGEUR	318
SMITH-PETERSON LAMINECTOMY RONGEUR	315	STELLE-LUER RONGEUR FORCEPS	314
SMITHWICK DURA DISSECTOR	344	STELLE-RUSKIN BONE RONGEUR	314
SMITHWICK CLIP APPLYING FORCEPS	340	STITCH SCISSORS	43
SMITHWICK NERVE DURA HOOK	342	STOCKMANN PENILE CLAMP	364
SOFIELD RETRACTOR	139	STONE TISSUE FORCEPS	62
SOLID COPPER HEAD MALLET	191	STONE-WATT CLOSING FORCEPS	342
SOLZ AREOLA MARKER	182	STONE-WATT INTERSTITIAL ANASTOMOSIS CLAMP	348
SOLZ ATRAUMATIC BREAST DISSECTOR	182	STRABISMUS HOOK	382
SOLZ BREAST HOOK DISSECTOR	182	STRASDELL-ST-LAS RETRACTOR	132
SOMER KIDNEY ELEVATING STONE CLAMPS FORCEPS	357	STRASSMANN HONEY ELEVATING STONE CLAMPS FORCEPS	387
SPARE BLADE	32	STRAUPE NEEDLE HOLDERS	102,389
SPATULA	24	STRAUPE NEEDLE HOLDERS T.C	114
SPATULA BREAST RETRACTOR DISSECTOR	183	STRAUSS PENILE CLAMP	363
SPECIMEN AND ASPIRATING CURETTE	397	STRUMPFEL EAR FORCEPS	333
SPECULUMS & CALIPERS	384	SUBACROMION SPREADER	324
SPENCER CORYMBARY NEEDLE HOLDERS T.C	119	SUCTION AND BRISATION CANNULAE	19
SPENCER STITCH SCISSORS	43	SUCTION CANNULA FOR TONSILLECTOMY ORAL	18
SPENCER-WELLS HAEMOSTATIC FORCEPS SLENDER TYPE	83	SUCTION ELEVATOR	164
SPIRAL DISTRACTOR	338	SUCTION TUBE, GADE NEEDLE	29
SPIRAL RASPATORY	304	SUCTION TUBES	16-18
SPLINTER FORCEPS	74,75,76	SULLIVAN SCISSORS	43
SPLIT LAMP	420	SUPER CUT SCISSORS	55
SPRATT BONE CURETTE / HOLLOW HANDLE	195	SUPRA CUT DISTRACTION SCREW	337
SPREADER PLASTER	54	SUPRA CUT DISTRACTION SCREW GRABER	337
SPURT LAMP	420	SURGDONS NEEDLES	125,126
SPURLING - HARRISON LAMINECTOMY RONGEURS	391	SUTURE RETRIEVAL HOOK	398
SPURLING INTERVERTEBRAL DISC RONGEURS	347,348,352	SUTURE TYING FORCEPS	385,387
SPURLING LAMINECTOMY RONGEURS	382,393	SWEDISH PATTERN DRESSING FORCEPS	68
SPUTUM MUG	430	SYFERT RONGEUR	316
S-SHAPED BLUNT CANNULA	78	SYSTRUNK SCISSORS	48
S-SHAPED RETRACTOR	144		
ST. CLAIR-THOMSON ADENOID CURETTE	315		
ST. THOMAS KNIFE	299		
STACKE PROBE	81		
STAGBEE/CLE BONE REDUCTION FORCEPS	322		
		STANDARD DRESSING FORCEPS	67
		STANDARD DRESSING FORCEPS NARROW POINT	67
		STANDARD DRESSING FORCEPS SERRATED	67
		STANDARD DRESSING FORCEPS T.C	78
		STANDARD NON ROTATING	341
		STANDARD OPERATING SUPER CUT SCISSORS	55
		STANDARD OPHTHALMOSCOPE	18
		STANDARD OPHTHALMOSCOPE SET	69
		STANDARD OTOSCOPE + OPHTHALMOSCOPE SET	69
		STANDARD OTOSCOPE SET	69
		STANDARD ROTATING	341
		STANDARD TISSUE FORCEPS	67
		STAUDE - MOORE TENACULUM FORCEPS	388
		ST-CLAIR THOMSON NASAL SPECULUM	383
		STELLBRINK BONE RONGEUR	313
		STERILE SCALPEL BLADE SIZE # 10	27
		STERILE SCALPEL BLADE SIZE # 10A	27
		STERILE SCALPEL BLADE SIZE # 11	27
		STERILE SCALPEL BLADE SIZE # 11P	27
		STERILE SCALPEL BLADE SIZE # 12	27
		STERILE SCALPEL BLADE SIZE # 13	27
		STERILE SCALPEL BLADE SIZE # 15	27
		STERILE SCALPEL BLADE SIZE # 15A	27
		STERILE SCALPEL BLADE SIZE # 17	27
		STERILE SCALPEL BLADE SIZE # 18	27
		STERILE SCALPEL BLADE SIZE # 20	27
		STERILE SCALPEL BLADE SIZE # 21	27
		STERILE SCALPEL BLADE SIZE # 22	27
		STERILE SCALPEL BLADE SIZE # 23	27
		STERILE SCALPEL BLADE SIZE # 24	27
		STERILE SCALPEL BLADE SIZE # 25	27
		STERILE SCALPEL BLADE SIZE # 26	27
		STERILE SCALPEL BLADE SIZE # 40	27
		STERILE SCALPEL BLADE SIZE # 6	27
		STERILE SCALPEL BLADE SIZE # 6B	27
		STERILE SCALPEL BLADE SIZE # 7B	27
		STERILE SCALPEL BLADE SIZE # C11	27
		STERILIZING BOXES (WITH SILICON PADS)	399
		STERILIZING DRUMS	434
		STERILIZING FORCEPS	434
		STERNBERG LIP AND CHEEK RETRACTOR	324
		STERNBERG RETRACTOR	133
		STERNUM NEEDLE HOLDERS T.C	118
		STETHOSCOPES	67
		STEVENS OPERATING SCISSORS T.C INSERT	59
		STEVENS SCISSORS	47
		STEVENS TENOTOMY SUPER CUT SCISSORS	55
		STEVENS TISSUE FORCEPS	73
		STEGELITZ FORCEPS WITH MEGALOPYING MIRRORS	73
		STEDLITZ SPLINTER FORCEPS	78
		STELLE	188,188
		STELLE BONE RONGEUR	314
		STELLE CHESEL	188,188
		STELLE GAUGE	188,188
		STELLE HAEMOSTATIC FORCEPS	67
		STELLE OSTIOTOME	188,188
		STELLE PATTERN DRILL SET	328
		STELLE PLASTER SHEARS	34,328
		STELLE-SARRAYA TISSUE FORCEPS	65
		STELLE-WHEELLEY BONE CUTTING FORCEPS	318
		STELLE-LEUR RONGEUR	315
		STELLE-LUSTON BONE CUTTING RONGEUR FORCEPS	317,318
		STELLE-LUER SCALIN BUCK BILL RONGEUR	318
		STELLE-LUER RONGEUR FORCEPS	314
		STELLE-RUSKIN BONE RONGEUR	314
		STITCH SCISSORS	43
		STOCKMANN PENILE CLAMP	364
		STONE TISSUE FORCEPS	62
		STONE-WATT CLOSING FORCEPS	342
		STONE-WATT INTERSTITIAL ANASTOMOSIS CLAMP	348
		STRABISMUS HOOK	382
		STRASDELL-ST-LAS RETRACTOR	132
		STRASSMANN HONEY ELEVATING STONE CLAMPS FORCEPS	387
		STRAUPE NEEDLE HOLDERS	102,389
		STRAUPE NEEDLE HOLDERS T.C	114
		STRAUSS PENILE CLAMP	363
		STRUMPFEL EAR FORCEPS	333
		SUBACROMION SPREADER	324
		SUCTION AND BRISATION CANNULAE	19
		SUCTION CANNULA FOR TONSILLECTOMY ORAL	18
		SUCTION ELEVATOR	164
		SUCTION TUBE, GADE NEEDLE	29
		SUCTION TUBES	16-18
		SULLIVAN SCISSORS	43
		SUPER CUT SCISSORS	55
		SUPRA CUT DISTRACTION SCREW	337
		SUPRA CUT DISTRACTION SCREW GRABER	337
		SURGDONS NEEDLES	125,126
		SUTURE RETRIEVAL HOOK	398
		SUTURE TYING FORCEPS	385,387
		SWEDISH PATTERN DRESSING FORCEPS	68
		SYFERT RONGEUR	316
		SYSTRUNK SCISSORS	48
		T.C OEHLER TISSUE FORCEPS	78
		TAHARASH NASAL CUTTING FORCEPS T.C	18
		TANGENTIAL OCCLUSION FORCEPS	371

DESCRIPTION	PAGE#
TAP SLEEVE	231
TANNER OBSTETRICAL FORCEPS	488
TAY-GORSON BONE CURETTE	187
TAYLOR HAMMER	82
TAYLOR RETRACTOR	388
TAYLOR SPINAL RETRACTORS	138
TEALE HERNIA DIRECTOR	387
TEALE TENACULUM FORCEPS	385
TEBBETTS BREAST AUGMENTATION FIBER OPTIC	169
TEBBETTS BREAST AUGMENTATION FIBER OPTIC RETRACTOR	168
TEBBETTS FIBER OPTIC RETRACTOR	168,169
TEBBETTS RETRACTOR	168
TECHNICAL FORCEPS	211
TEMPORAL T DISSECTOR	183
TENACULUM EMMETT	385
TENACULUM FORCEPS	388,389
TENDON HOOKS RETRACTOR	138
TENDON SIZING FORCEPS	89
TENDON STRIPPERS, BONE LEVERS	288
TENDON STRIPPERS, TECHNICAL FORCEPS	218
TENDON TUNNELING FORCEPS	389
TENNYT TYING FORCEPS	388
TENDONORY, CAPSULOTOMY WANNAS SCISSORS	389
TRAGER RIB GRAFT RETRACTOR ADULT	178
T-HANDLE AD COUPLING	228
T-HANDLE FOR AD COUPLING	228
THEBERG SCROTOMES	32
THIGH - LOWER LEG CANNULAS	413
THIN FOOTPLATE KRISKON LAMINECTOMY PUNCH	381
THOLE PELVIMETER, OBSTETRICAL FORCEPS	486
THOMAS-ALLIS INTESTINAL AND TISSUE GRASPING FORCEPS	338
THOMAS-GAYLOR BIOPSY FORCEPS	384
THOMSON WALKER BLADDER RETRACTOR	388
THOMSON WALKER NEEDLE HOLDERS	183
THOMSON WALKER PERILE CLAMP	82
THOMSON-WALKER NEEDLE HOLDERS T.C	118
THOMSON-WALKER'S PERILE CLAMPS	82
THORACIC & ILM & RIB RETRACTORS	387
THORACIC RIB RETRACTORS	387
THORPE TISSUE & DRESSING FORCEPS	78
THURCHUM (GOLDMITH) NASAL SPECULUM	380,383
TOEK-HALLE NASAL SPECULUM	384
TILLET NASAL POLYPUS AND SEPTUM FORCEPS	217
TISCHLER - MORGAN BIOPSY AND SPECIMEN FORCEPS	388
TISCHLER BABY BIOPSY FORCEPS	388
TISCHLER BIOPSY FORCEPS	387
TISSUE & DRESSING FORCEPS	81-73
TISSUE & DRESSING FORCEPS T.C	77
TISSUE FORCEPS	83,88,71
TOSOLD TONGUE DEPRESSOR	324
TOENNIS DURA DISSECTOR	344
TOENNIS HOOK & SKIN HOOK	127
TOENNIS NEEDLE HOLDERS	188
TOENNIS NEEDLE HOLDERS T.C	113
TOENNIS NERVE DURA HOOK	342
TOKIHO TOWEL FORCEPS	83
TOLEDO CANNULAS	414
TONGUE SPATULA	129
TONOMETER SET	
TONGUE INSTRUMENTS	80,318,328
TONGUE KNIFE	388
TONGUE KNIVES	388
TONGUE NEEDLE SUCTION & IRRIGATION CANNULA	79
TONGUE, NASAL SCISSORS	44
TONGUE FORCEPS	83
TOWNLEY CALIPER	13
TOYBIER EAR SPECULUM	378
TRACHEA DILATORS, TRACHEA TUBES	321
TRACHEAL RETRACTOR	128
TRACHEOTOMY BRONCHO-OESOPHAGOSCOPY FORCEPS SET	332
TRACHEOTOMY SET	332
TRANSORAL DISSECTOR	183
TRAUBE HAMMER	82
TRAYERS RETRACTOR	172
TRELAT ELEVATOR	381
TRELAT VAGINAL SPECULUM	388
TRETHOWAN'S BONE ELEVATOR	384
TREVES TISSUE FORCEPS	82
TREDEMANL KMPF	31
TROCAR	18
TROCAR BREAST TUBE	183
TROCARS	18,18
TROELTSCH DRESSING FORCEPS	318
TROELTSCH FORCEPS	88
TROEMNER HAMMER	82
TROEMNER SIMPLEX HAMMER	82
TROELTSCH EUSTACHIAN CATHETERS	88
TROUSSEAU TRACHEA DILATOR 2 PRONG	321
TROUTMAN MICRO SCISSORS	48
TROUTMAN NEEDLE HOLDERS	188
TROUTMAN-CASTROVIEJO SCISSORS	389
TROUTMAN-CHRIS BLADE BREAKER & HOLDER ANGLED, WITH PUSH-PULL LOCK	38
TROUTMAN-CHRIS BLADE BREAKER & HOLDER WITH PUSH-PULL LOCK	38
TUBES RETRAL VALVE AORTIC DILATOR	378
TUNING CLAMP	84
TUNING CLAMP WITH PROTECTOR	84
TUPPIER / HABERER RETRACTOR	188

DESCRIPTION	PAGE#
TUPPIER HAEMOSTATIC FORCEPS	95
TUPPIER RETRACTOR	144,148
TUPPIER RIB RETRACTORS	388,387
TUPPIER TISSUE FORCEPS	338
TURAKIN EAR SPECULUM	388
TURING FORKS	388,389
TURING FORKS NEURAL WITH HAMMER	388
TURING FORKS SET	388
TURPERS HAND RETRACTOR SET	173
TURNBULL NIPPERS	87
TURNER-DOPPER RETRACTORS	148
TYING TONGUE SNARE	387
U	
U.S. ARMY PATTERN	188
UCKERBAHN TRACHEA TUBES	321
UCKERBAHN TROCAR	18
UFFENORDE BONE CURETTE LEFT	185
UFFENORDE BONE CURETTE RIGHT	185
ULRICH BONE HOLDING FORCEPS	224
ULRICH BONE HOLDING SELF RETAINING FORCEPS	224
ULRICH SPONGE FORCEPS	88
UNI - BURKE BIOPSY AND SPECIMEN FORCEPS	382
UNI - REYNOLDS BIOPSY AND SPECIMEN FORCEPS	382
UNI - ORAL BIOPSY AND SPECIMEN FORCEPS	382
UNI - RANDALL ASPIRATING CURETTE	387
UNI - RANDALL ASPIRATING CURETTE	387
UNI - TISCHLER BIOPSY AND SPECIMEN FORCEPS	382
UNI - TOWNSEND BIOPSY AND SPECIMEN FORCEPS	382
UNIVERSAL ABDOMINAL TROCAR SET	18
UNIVERSAL BONE HONGEUR	213
UNIVERSAL FAT INJECTION SYRINGE	423
UNIVERSAL HAMMER	182
UNIVERSAL OTOSCOPE & OPHTHALMOLOGY SET	88
UNIVERSAL PARAMEDIC SHEAR	88
UNIVERSAL RIB BENDER	332
UNIVERSAL SCISSORS	88
UNIVERSAL WIRE CUTTING SCISSORS	48
URETHRAL CATHETERS	382,383
URINAL - FEMALE	438
URINAL - MALE	438
URO-TANGENTIAL GALL STONE FORCEPS	388
USA MODELL SPECIMEN FORCEPS	388
US-ARMY RETRACTOR	138
UTERINE CURETTES	488-482
UTERINE DILATORS	388
UTERINE SCOPES, SUCTION CURETTES & UTERINE DEPRESSOR	388
UTERINE EXPLORER	388,387,384
UTERINE SPONGES	483
UTERUS HOLDING FORCEPS	387
UTILITY STERILIZING FORCEPS	434
UTILITY TECHNICAL FORCEPS PLIERS	318
UTRATA CAPSULOTOMERS FORCEPS	288-287
V	
VACHER NASAL SPECULUM	388
VAGINAL DRESSING FORCEPS	383
VAGINAL SPECULA	383-378
VAGINAL SPECULA, VAGINAL RETRACTORS	374
VALLER UTERINE SOUND	384
VAN BUREN SEQUESTERUM FORCEPS	333
VAN BUREN URETHRAL SOUND	382
VAN DOREN BIOPSY FORCEPS	384
VANNAS SCISSORS	388,389
VANROOSE VAIN PROSE SET	283
VASCULAR FORCEPS	388,388
VASCULAR SCISSORS	48,42
VERBRIDGE SELF-CENTERING BONE HOLDING FORCEPS	224
VERBRIDGE BONE HOLDING FORCEPS	328,328
VERNER CALIPER	13
VERNON-DWIG INTESTINAL RECTAL SPECULUM	381
VERONIKS VAGINAL RETRACTORS	378
VESTIBULUM RETRACTOR	324
VICKERS MALLETS	183
VIENNA SPECULUM	384
VIGNON DISSECTING KNIVES	31
VITAL HEAVY DUTY PLIERS T.C	318
VITAL WIRE CUTTER	378
VITAL WIRE EXTRACTION PLIERS T.C	318
VITRECTOMY SCISSORS	389
VITREORETINAL FORCEPS	389
VOLKMAN RETRACTOR	131
VOLKMAN BONE CURETTE	185
VOLKMAN CURETTE	185
VOLKMAN RETRACTORS	131,134
VOLTOLIN NASAL SPECULUM	388
VON GRAEFE KMPF	383
VON GRAEFE STRABISMUS & SKIN HOOKS	138
W	
WACHENFELD TISSUE FORCEPS	75,76
WAGNER EAR LOOPS - HOOKS	388
WAGNER HOOKLET & SKIN HOOKS	128
WALB DISSECTING KNIVES	31
WALDMANN PLASTER SCISSORS	82
WALDMANN SCISSORS	82
WALLICH OVUM CURETTE	488
WALTER ALAR AND NASAL RETRACTOR	171
WALTER GONGE	188

DESCRIPTION	PAGE#
WALTON-LISTON BONE CUTTING RONGEUR FORCEPS	218
WANGENSTEIN DRESSING FORCEPS	82
WANGENSTEIN DRESSING FORCEPS T.C.	78
WANGENSTEIN NEEDLE HOLDERS	106
WANGENSTEIN NEEDLE HOLDERS T.C.	112
WARTENBERG PINWHEEL	82
WASH RASH	428
WASSMUND RETRACTOR	135
WATSON DERMATOMES	32
WATSON-CHEYNE ELEVATORS	308
WATSON-CHEYNE RASPATORY	312
WATSON-WILLIAMS NASAL CUTTING FORCEPS	319
WAUGH DRESSING FORCEPS	83
WAUGH TISSUE FORCEPS	83
WEBER ADHESIONMETER	81
WEBSTER NEEDLE HOLDER	101
WEBSTER NEEDLE HOLDERS T.C.	117
WECHER SCISSORS	45,208
WEL NASAL CUTTING FORCEPS	319
WEL-BLANDESLEY NASAL CUTTING FORCEPS	308
WEINBERG WAGOTOMY RETRACTOR (JOE'S HOC)	147
WEINBARTH EAR FORCEPS	333
WEISSBARTH SPECULUM & RETRACTOR	377
WEITLANER RETRACTOR	104,108
WELL BLANDESLEY LAMINECTOMY RONGEURS	248
WELLSCHLUFF NASAL SAW	182
WERTHEIM HAEMOSTATIC FORCEPS	80
WERTHEIM HAEMOSTATIC TISSUE FORCEPS	81
WERTHEIM HYSTERECTOMY FORCEPS	89
WERTHEIM NEEDLE HOLDERS	104
WERTHEIM NEEDLE HOLDERS T.C.	112
WERTHEIM PARAMETRIUM CLAMPS	81
WERTHEIM RETRACTOR	378
WERTHEIM-CULLEN HAEMOSTATIC FORCEPS	80
WESTCOTT MICRO SCISSORS	48
WESTCOTT SCISSORS	388
WESTERMARK HAEMOSTATIC FORCEPS	89
WESTBACOTT NASAL POLYPUS AND SEPTUM FORCEPS	317
WHITE TONGUE BINDING FORCEPS	338
WHITEHEAD MOUTH GAG	338
WHITTAKER TENACULUM 3 PRONG	386
WIDE MOUTH EJECTOR KERRISON LAMINECTOMY RONGEURS	221,223
WIEDER BREAST AND FACIAL RETRACTOR / TONGUE DEPRESSOR, SERRATED	166
WIEDER BREAST AND FACIAL RETRACTOR / TONGUE DEPRESSOR, SERRATED	166
WIEDER TONGUE DEPRESSOR	318
WIENER HOOK & SAWN HOOK	137
WIENER NASAL SAW	314
WILDE FORCEPS	68
WILDE INTERVERTEBRAL DISC RONGEURS	248
WILDE NASAL DRESSING FORCEPS	218
WILDER LACRIMAL DILATOR	33
WILLET-MARTIN HAEMOSTATIC FORCEPS	88
WILLIAM LACRIMAL PROBE DOUBLE ENDED, STERLING SILVER	33
WILLIAM PROBE	33
WILLIAMS GRASP FORCEPS	338
WILLIAMS STYLE MICRO DISC INTERVERTEBRAL DISC RONGEURS	248
WILLIGER CURLETTE	188,198
WILLIGER ELEVATOR	201
WILLIGER HAMMER	181
WILLIGER MALLETS	182
WINKELBACH CIRCUMCISION CLAMPS	384
WINTER ABORTION FORCEPS	386
WINTER TENACULUM FORCEPS	385
WINTERTON VAGINAL SPECULUM	388
WIRE BENDING FORCEPS	218
WIRE CUTTING INSTRUMENTS	218,228
WIRE CUTTING SCISSORS	46
WIRE CUTTING SCISSORS T/C INSERT	58
WIRE FORCEPS	238
WIRE GUIDE	336
WIRE INSTRUMENTS	332
WIRE RETAINING RETRACTOR	101
WIRE SPECULUMS	204
WIRE TIGHTENING NEEDLE HOLDERS T.C.	117
WIRE TWISTERS NEEDLE HOLDERS T.C.	118
WIRE VECTOR	282
WITH FIBER OPTIC ILLUMINATION	171
WITMER BOPSY AND SPECIMEN FORCEPS	388
WITMER BOPSY FORCEPS	388
WOLFF SPREADER PLASTER	54
WOODSON DURAL SEPARATOR/PACKER	388
WOODSON ELEVATOR/SPATULA	388
WRENCH KIRSCHNER EXTENSION BOWS	333
WRIGLEY OBSTETRICAL FORCEPS	487
WULLSTEIN RETRACTOR	103
WULLSTEIN SUCTION TUBE COMPLETE	17
Y	
YANCOVSKIE RETRACTOR	177
YANKAUER NASAL SPECULUM	386
YANKAUER SUCTION TUBE	17
YASARGIL FORCEPS	68,69
YASARGIL NERVE DURA HOOK RETRACTOR	243
YASARGIL NEURO-MICRO DISSECTOR	246
YASARGIL SCISSORS	68
YECMAN BOPSY FORCEPS	335
YECMAN INTESTINAL POLYOUS GRASPING FORCEPS	347

DESCRIPTION	PAGE#
YECMAN POLYOUS GRASPING FORCEPS	383
YOUNG LOBB HOLDING FORCEPS	389
YOUNG NEEDLE	123
YOUNG PROSTATIC RETRACTOR	389
Z	
ZAMPAL-JARSEN BONE RONGEUR	212
ZIEGLER CLIP FORCEPS	74
ZIEGLER PROTECTION CAP	81
ZIEGLER MEASURE CLAMP	385
ZIMMERMAN MYOTOME, CHISEL TIP	484
ZIMMERMAN MYOTOME, SPOON TIP	484
ZOLLNER EAR SPECULUM	386
ZOLLNER SUCTION TUBE	23
ZWEIFEL DOUBLE ENDED	389
ZWEIFEL NEEDLE HOLDERS T/C	121
ZYGMATIC ARCH ELEVATOR	164



Manufacturers & Exporter of Surgical Instruments
Roras Road, Muzafar Pur, 51310,
Sialkot Pakistan

Tel: +92 52 3254190, Fax: +92 52 3257067
E.mail: info@mithubro.com
URL: www.mithubro.com