

Dental Instruments Catalogue



MITHU BROTHERS



Dear Valued Buyers

We feel immense pleasure to present our latest catalogue in which we have featured a most comprehensive range of all types of quality Surgical & Dental instruments required for day to day use for Hospital. We will be pleased to quote you a competitive Price and Delivery time.

All instruments are manufactured according to the recognized standard patterns currently in use in Hospital throughout the world and are being produced under restrict control of experts to avoid any flaw and to refrain any complaint at any stage.

A group of very vast experienced persons in manufacturing handling our quality Control System.

Any instruments proven defective in workmanship or material will be replaced with out charges.

We express our thanks to all our customers for the confidence they have placed us in the past. We further assure them that we will continue our best efforts to gain their confidence in the future.

We are always at your service.

Chief Executive

MITHU BROTHERS

EXTRACTING FORCEPS

Handle Selection For Extracting Forceps

Dear Valued Buyers if any Universal Fig. No. of Extracting Forceps not Found in our Catalogue you Can Refer the Fig. No. From These Diagram.

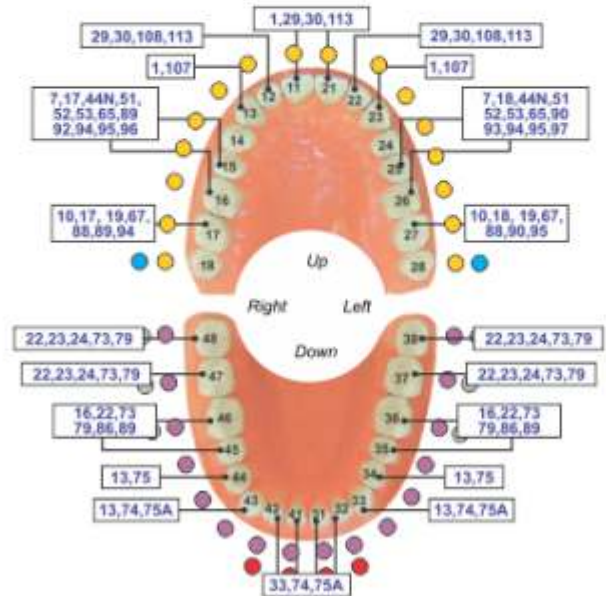
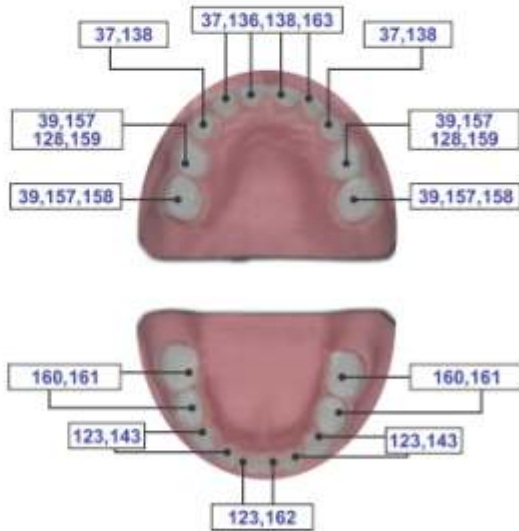

Dear Valued Buyers these are our Handle Styles



English Pattern



English Pattern



English Pattern, Anatomical Handle



American Pattern



Deep Grip Forceps With Hole Pattern



Hole Pattern



A



B



C



D



E



F



EXTRACTING FORCEPS (English Pattern)

- Щипцы экстракционные (английская форма)
- Daviers (Forme Anglaise)
- Zahnzangen (Englische Form)

- Щипці екстракційні (англійська форма)
- Forceps de Extracción (Forme Inglesa)
- استخراج المنطق (نمط اللغة الإنجليزية)



DE-001
Fig. 1
Upper Centrals
and Canines



DE-002
Fig. 2
Upper Laterals
and Canines



DE-003
Fig. 4
Lower Incisors
and Canines



DE-004
Fig. 7
Upper Premolars



DE-005
Fig. 8
Lower Premolars



DE-006
Fig. 13
Lower Premolars



DE-007
Fig. 17
Upper Molars,
Right



DE-008
Fig. 18
Upper Molars,
Left



DE-009
Fig. 21
Lower Molar



DE-010
Fig. 22
Lower Molar



EXTRACTING FORCEPS (English Pattern)

- Щипцы экстракционные (английская форма)
- Dáviers (Forme Anglaise)
- Zahnzangen (Englische Form)
- Щипці екстракційні (англійська форма)
- Forceps de Extracción (Forme Inglesa)
- استخراج المنقذ (نمط اللغة الإنجليزية)



DE-011
18A
upper molars



DE-012
19
upper third molars



DE-013
20
lower third molar



DE-014
24
lower molar, right



DE-015
29
upper roots



DE-016
30
Upper Roots



DE-017
33
lower roots



DE-018
33A
Lower Roots



DE-019
33M
Lower roots
with long beak



DE-020
46L



DE-021
51
Upper Roots



DE-022
51A
Upper Roots



- Щипцы экстракционные (английская форма)
- Щипці екстракційні (англійська форма)
- Daviers (Forme Anglaise)
- Forceps de Extracción (Forme Inglesa)
- Zahnzangen (Englische Form)
- استخراج المنقط (نمط اللغة الإنجليزية)

WISDOM EXTRACTING FORCEPS



DE-023
Routurier
(# 22 ½ L)
lower molars and
wisdoms, left



DE-024
Routurier
(# 22 ½ R)
lower molars and
wisdoms, right



DE-025
Routurier
(# 33 ½ L)
lower molar and
wisdom roots, left



DE-026
Routurier
(# 33 ½ R)
lower molar and
wisdom roots, right



DE-027
Fig. 186L
lower molars



DE-028
Fig. 186R
lower molars



DE-029
51AL



DE-030
67
Upper Thrid Molars



DE-031
67A
Upper Thrid Molars



DE-032
79
Lower Third Molars



EXTRACTING FORCEPS (English Pattern)

- Щипцы экстракционные (английская форма)
- Daviers (Forme Anglaise)
- Zahnzangen (Englische Form)
- Щипці екстракційні (англійська форма)
- Forceps de Extracción (Forme Inglesa)
- استخراج المنطق (نمط اللغة الإنجليزية)



DE-033
73
Lower Molars



DE-034
73 A
lower molars



DE-035
73 S



DE-036
74
Lower Roots



DE-037
74N
Lower Roots



DE-038
75
Lower Premolars



DE-039
86A
Lower Molars



DE-040
86B
lower molars



DE-041
86C
lower molars



DE-042
87
Lower Molars



DE-043
89
Upper Molars,
Right



DE-044
90
Upper Molars,
Left



EXTRACTING FORCEPS (English Pattern)

- Щипцы экстракционные (английская форма)
- Daviers (Forme Anglaise)
- Zahnzangen (Englische Form)

- Щипці екстракційні (англійська форма)
- Forceps de Extracción (Forme Inglesa)
- استخراج المنطق (نمط اللغة الإنجليزية)

A-TRAUMATIC EXTRACTION
Improved tapered beaks for complete root contact. Cross serrations.
Deep Gripe Extracting Forceps



- No Fracture
- No Tissue Damage
- Extraction With Easy



Thin Tip

DE-045
34

Upper incisors and
premolars
deep-gripping



Wide Tip

DE-046
34A

Upper centrals / cains
deep-gripping



Thin Tip

DE-047
Fig. 35

upper permolars
deep-gripping



Wide Tip

DE-048
35A

Upper incisors and
premolars
deep-gripping



Thin Tip

DE-049
36

Lower premolars
deep-gripping



Wide Tip

DE-050
36A

Lower premolars
deep-gripping



DE-051
336

lower permolars
deep-gripping



DE-052
F-7C

lower molar



DE-053
9

Apex Forceps Lower Universal
Deep Root Pick



DE-054
79N

Lower third molars
deep-gripping



DE-055
79

Lower Thrid Molars



EXTRACTING FORCEPS (English Pattern)

- Щипцы экстракционные (английская форма)
- Daviers (Forme Anglaise)
- Zahnzangen (Englische Form)
- Щипці екстракційні (англійська форма)
- Forceps de Extracción (Forme Inglesa)
- استخراج الملقط (نمط اللغة الإنجليزية)

DEEP GRIP FORCEPS



DE-056
146

Apex Forceps Lower Root
Deep Root Pick



DE-057
153

Apex Forceps Upper Root
Deep Root Pick



DE-058
149

Apex Forceps Upper Root
Deep Root Pick



DE-061
Fig. 44



DE-060
Fig. 44Z



DE-059
Fig. 45Z



DE-062
46XL
Apex Forceps Lower Root
Deep Root Pick



DE-063
67
Upper Third Molars



DE-064
67A
Upper Third Molars



DE-065
67N
Lower third molars
deep-gripping



DE-066
331
upper roots
deep-gripping



EXTRACTING FORCEPS (English Pattern)

- Щипцы экстракционные (английская форма)
- Daviers (Forme Anglaise)
- Zahnzangen (Englische Form)

- Щипці екстракційні (англійська форма)
- Forceps de Extracción (Forme Inglesa)
- استخراج المنطق (نمط اللغة الإنجليزية)



Fig. 1
upper
laterals
and canines



- DE-067** Set of 10 Pieces
 Fig. 1
 Fig. 7
 Fig. 13
 Fig. 17
 Fig. 18
 Fig. 22
 Fig. 51A
 Fig. 67
 Fig. 74N
 Fig. 79

Fig. 7
upper
premolars



Fig. 13
lower
premolars



Fig. 17
upper
molars,
right



Fig. 18
upper
molars,
left



Fig. 22
lower
roots



Fig. 51A
upper roots



Fig. 67
upper third
molars



Fig. 74N
lower
molar



Fig. 79
lower third
molars



EXTRACTING FORCEPS

- Щипцы экстракционные
- Daviers
- Zahnzangen
- Щипці екстракційні
- Forceps de Extracción
- استخراج الملقط

Pediatric Tooth Extracting Forceps Set



DE-069
English Pattern Klein #51S
Pedodontic Upper root



DE-068
English Pattern Klein #137
Pedodontic, Upper Incisors Spring handle



DE-072
English Pattern Klein #5
Pedodontic Lower Incisors.



DE-070
English Pattern Klein #139
Pedodontic Upper Premolars

Baby Tooth Extraction Forceps



Fig. # 01 to 07
Set of 7 Pieces



DE-073
English Pattern Klein #7
Pedodontic Lower Roots,



DE-071
English Pattern Klein #3
Pedodontic Upper Molars Universal

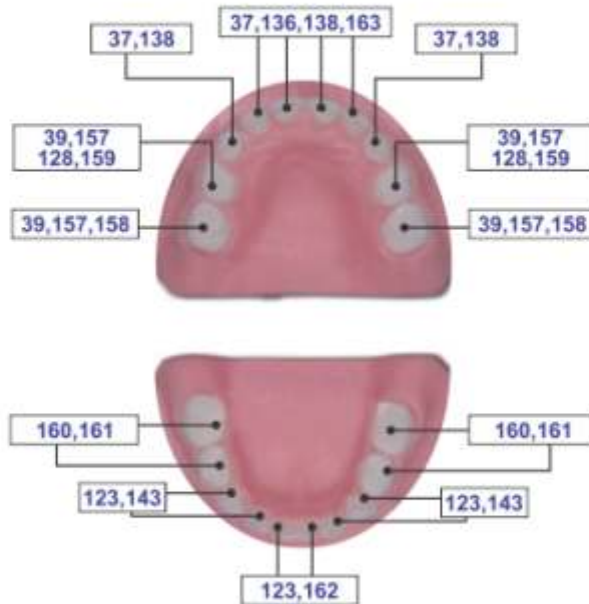

DE-074
English Pattern Klein #6
Pedodontic Lower Molars, Spring Handle



EXTRACTING FORCEPS (American Pattern)

- Щипцы экстракционные (американская форма)
- Daviers - forme américaine
- Fórceps de extracción - forma americana
- Щипці екстракційні (американська форма)
- Pinzeta per estrazione - forma americana
- استخراج المنطق (النمط الأمريكي)



DE-075
1STD
Winter
upper centrals and canines



DE-076
Fig. 1
upper incisors
and roots



DE-077
Cryer
Fig. 150



EXTRACTING FORCEPS (American Pattern)

- Щипцы экстракционные (американская форма)
- Щипці екстракційні (американська форма)
- Daviers - forme américaine
- Pinzere per estrazione - forma americana
- Férceps de extracción - forma americana
- استخراج الملقط (النمط الأمريكي)

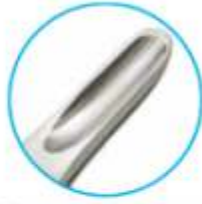

DE-078
Fig. 150A
Cryer
upper incisors, premolars, roots



DE-079
Fig. 62
incisors, premolars,
deciduous teeth



DE-080
10S
upper roots



DE-081
17
lower molars



DE-082
Harris
Fig. 18R

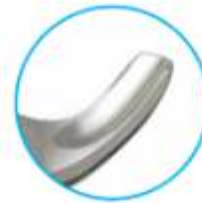

DE-083
Harris
Fig. 18L



EXTRACTING FORCEPS (American Pattern)

- Щипцы экстракционные (американская форма)
- Daviers - forme américaine
- Fórceps de extracción - forma americana
- Щипці екстракційні (американська форма)
- Pinzeta per estrazione - forma americana
- استخراج المنقط (النمط الأمريكي)



DE-084
Fig. 210
upper third molars



DE-085
Fig. 53R
upper molars, right



DE-086
Fig. 53L
upper molars, left



DE-087
NEVIUS
Fig. 88R

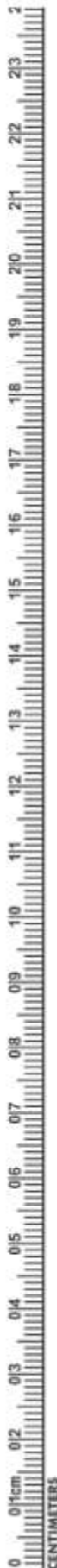

EXTRACTING FORCEPS (American Pattern)

- Щипцы экстракционные (американская форма)
- Daviers - forme américaine
- Férceps de extracción - forma americana
- Щипці екстракційні (американська форма)
- Pinzere per estrazione - forma americana
- استخراج الملقط (النمط الأمريكي)



DE-088
Fig. 24
upper molars



DE-089
210S
upper third molars



DE-090
210H
upper third molars



DE-091
286
Upper Roots,
Premolars, Incisors



DE-092
99C
Kells
upper incisors,
canines, premolars



DE-093
222
lower third molars



DE-094
286
Lower Molar



EXTRACTING FORCEPS (American Pattern)

- Щипцы экстракционные (американская форма)
- Daviers - forme américaine
- Férceps de extracción - forma americana
- Щипці екстракційні (американська форма)
- Pinzeta per estrazione - forma americana
- استخراج المنطق (النمط الأمريكي)



DE-095
Nevis
Fig. 88L
upper molars, left



DE-096
Fig. 65
upper incisors
and roots



DE-097
Parmly Fig. 32A
upper premolars
and roots



DE-098
Parmly Fig. 32
upper premolars
and molars



EXTRACTING FORCEPS (American Pattern)

- Щипцы экстракционные (американская форма)
- Daviers - forme américaine
- Fórceps de extracción - forma americana
- Щипці екстракційні (американська форма)
- Pinzere per estrazione - forma americana
- استخراج الملقط (النمط الأمريكي)

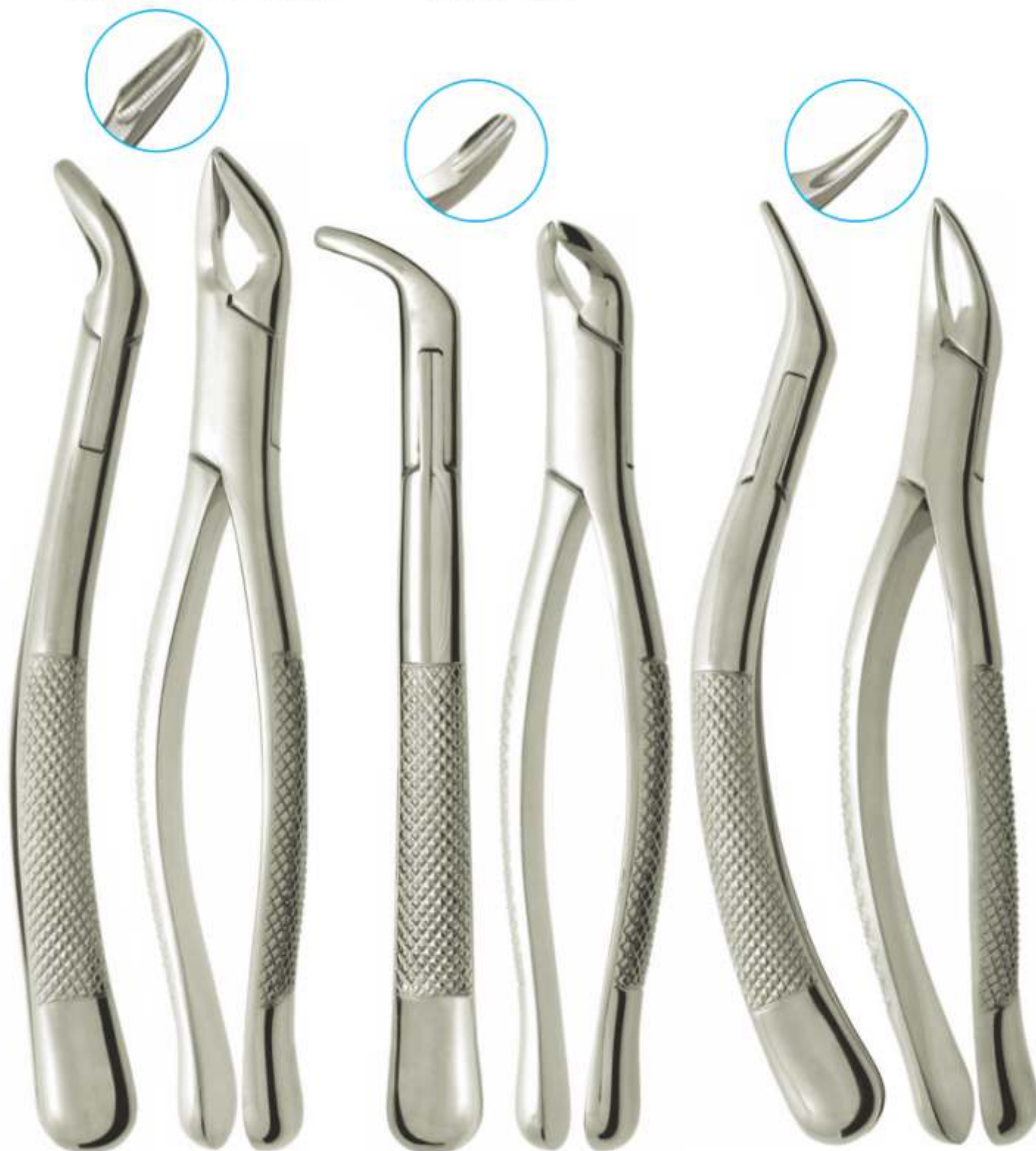

DE-099
COHEN
universal

DE-100
Fig. 203
lower incisors
and roots

DE-101
Tomes Fig. 69
upper and lower
roots

ROOT ELEVATOR

- Элеватор корневой экстракционный
- Элеватор корневий екстракційний
- Elevadores para raices
- المعاصر الجذر
- Elévateurs à racines

Apexo Root Elevators



Apexo



DE-150
Apexo
2.5x9mm
Straight



DE-151
Apexo
2.7x9mm
Straight



DE-152
Apexo
3.0x9mm
Straight



DE-153
Apexo
2.5x9mm
Curved



DE-154
Apexo
3.0x9mm
Curved



DE-155
Seldin
3.0x14mm
Straight

Luxator Root Elevators



Luxator



DE-156
Luxator
3mm
straight



DE-157
Luxator
3mm
curved



DE-158
Luxator
4mm
straight



DE-159
Luxator
4mm
curved



DE-160
Luxator
5mm
straight



DE-161
Luxator
5mm
curved

Bein Root Elevators



Bein



DE-162
Bein 2mm



DE-163
Bein 3mm



DE-164
Bein 4mm

Seldin Root Elevators



Seldin



DE-165
Flohr 1



DE-166
Seldin 34S



DE-167
Seldin 34



- Элеватор корневой экстракционный
- Elevator corneviu extracționii
- Elévateurs à racines
- Elevadores para raíces
- Wurzelheber
- المصاعد الجذر

Apexo Root Elevators



Apexo

DE-168
Apexo
2.5x9mm
Straight

DE-169
Apexo
2.7x9mm
Straight

DE-170
Apexo
3.0x9mm
Straight

DE-171
Apexo
2.5x9mm
Curved

DE-172
Apexo
3.0x9mm
Curved

DE-173
Seldin
3.0x14mm
Straight

Luxator Root Elevators



Luxator

DE-174
Luxator
3mm
straight

DE-175
Luxator
3mm
curved

DE-176
Luxator
4mm
straight

DE-177
Luxator
4mm
curved

DE-178
Luxator
5mm
straight

DE-179
Luxator
5mm
curved

Bein Root Elevators



Bein

DE-180
Bein 2mm

DE-181
Bein 3mm

DE-182
Bein 4mm

Seldin Root Elevators



Seldin

DE-183
Flohr 1
3.5 mm

DE-184
Seldin 34S
4 mm

DE-185
Seldin 34
5 mm

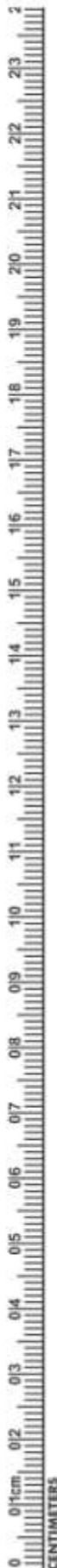

- Элеватор корневой экстракционный
- Elévateurs à racines
- Wurzelheber
- Elevator corneviu extracționii
- Elevadores para raíces
- المصاعد الجذر

Apexo Root Elevators



Apexo

DE-168
Apexo
2.5x9mm
Straight

DE-169
Apexo
2.7x9mm
Straight

DE-170
Apexo
3.0x9mm
Straight

DE-171
Apexo
2.5x9mm
Curved

DE-172
Apexo
3.0x9mm
Curved

DE-173
Seldin
3.0x14mm
Straight

Luxator Root Elevators



Luxator

DE-174
Luxator
3mm
straight

DE-175
Luxator
3mm
curved

DE-176
Luxator
4mm
straight

DE-177
Luxator
4mm
curved

DE-178
Luxator
5mm
straight

DE-179
Luxator
5mm
curved

Bein Root Elevators



Bein

DE-180
Bein 2mm

DE-181
Bein 3mm

DE-182
Bein 4mm

Seldin Root Elevators



Seldin

DE-183
Flohr 1
3.5 mm

DE-184
Seldin 34S
4 mm

DE-185
Seldin 34
5 mm

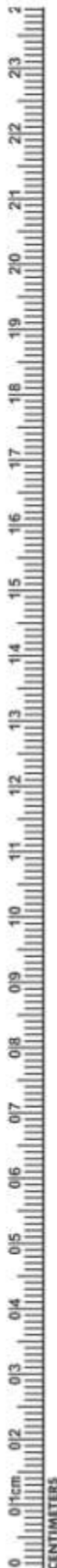

ROOT ELEVATOR

- Элеватор корневой экстракционный
- Elévateurs à racines
- Wurzelheber
- Слеватор корневий екстракційний
- Elevadores para raices
- المصاعد الجذر

Apical Root Elevators

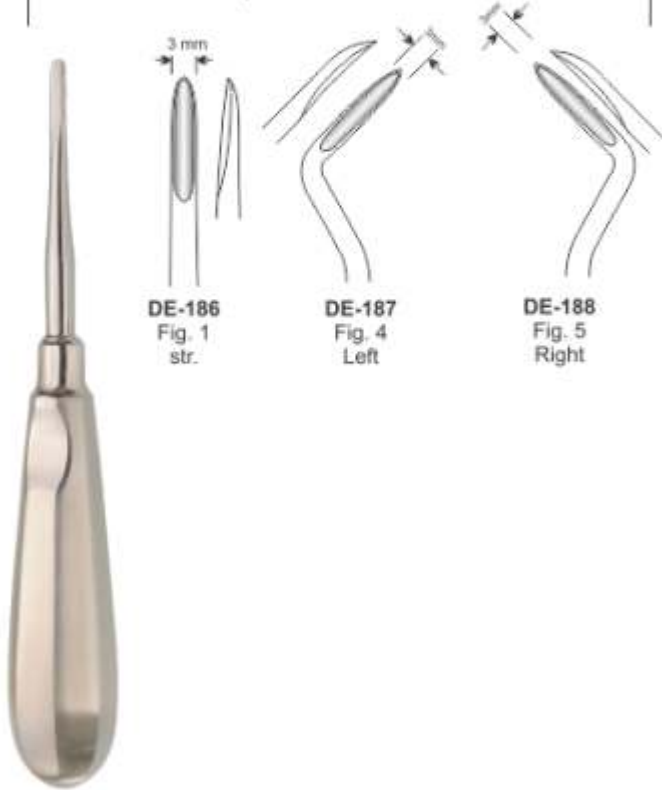

Apical Root Elevators

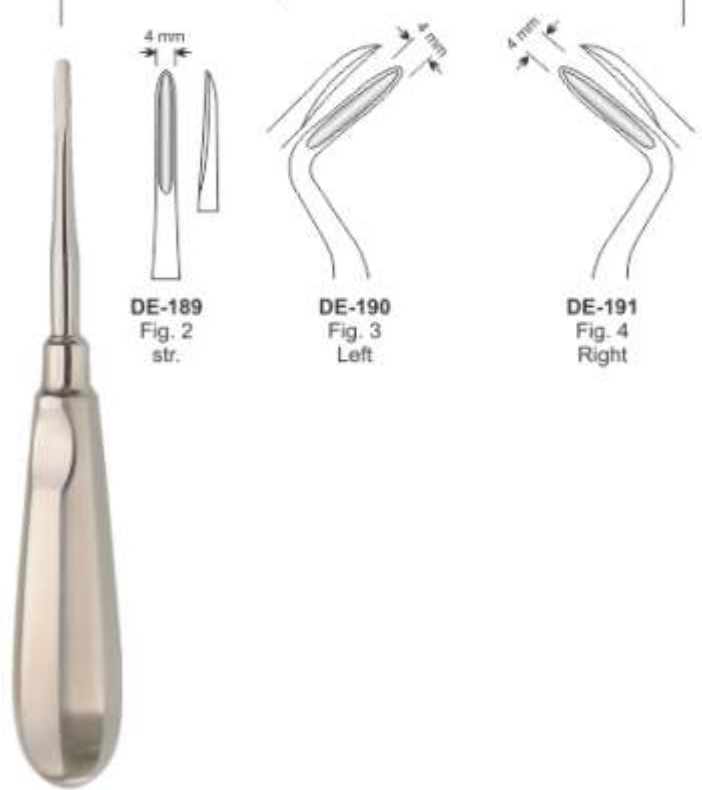

Coupland Root Elevators

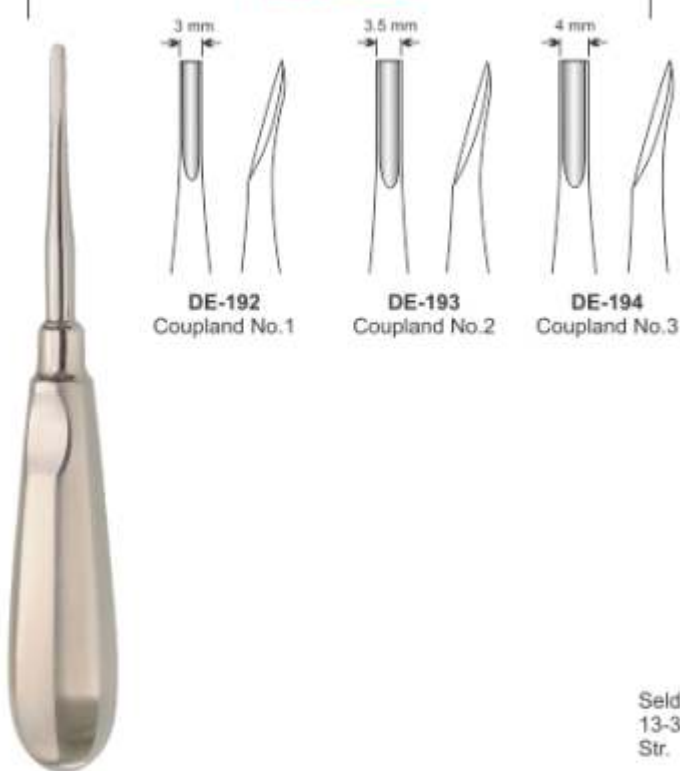

Seldin Root Elevators

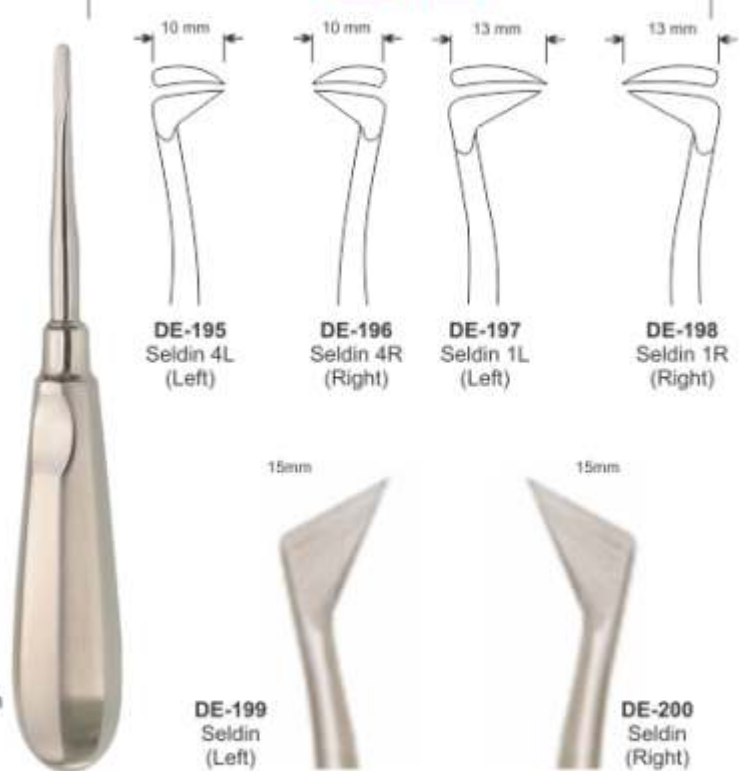

- Элеватор корневой экстракционный
- Elévateurs à racines
- Wurzelheber

- Elevator cornevil extraccionny
- Elevadores para raices
- المصاعد الجذر

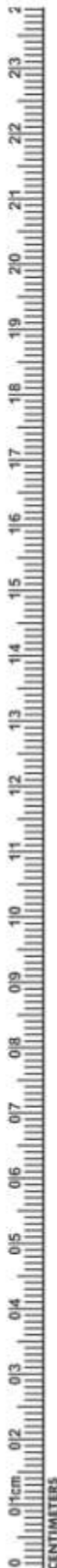

Apical Root Elevators

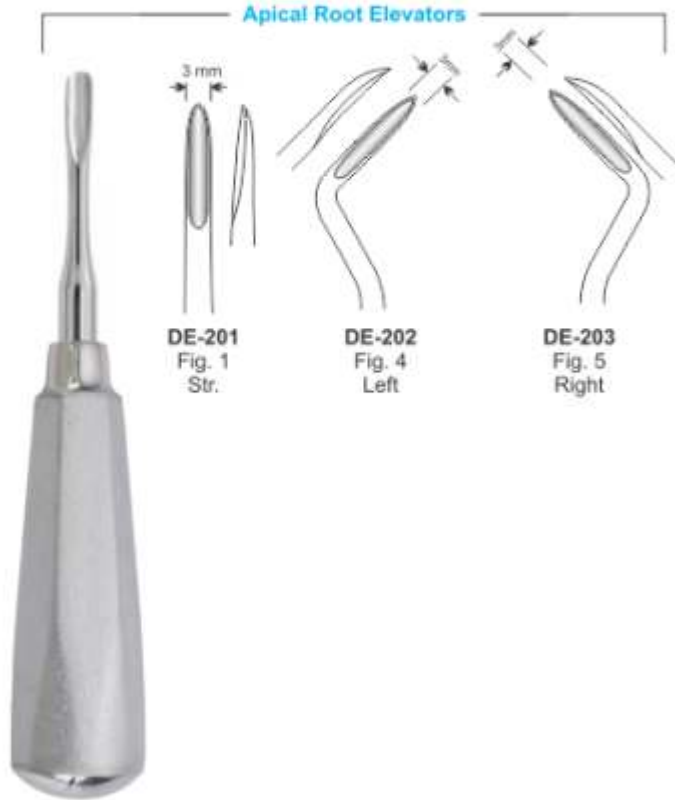

Apical Root Elevators

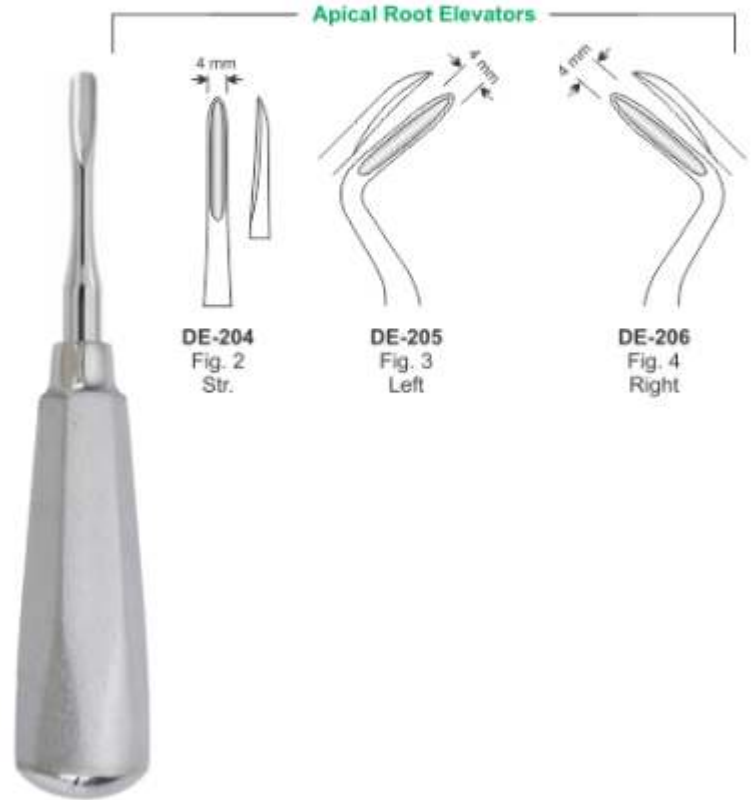

Coupland Root Elevators

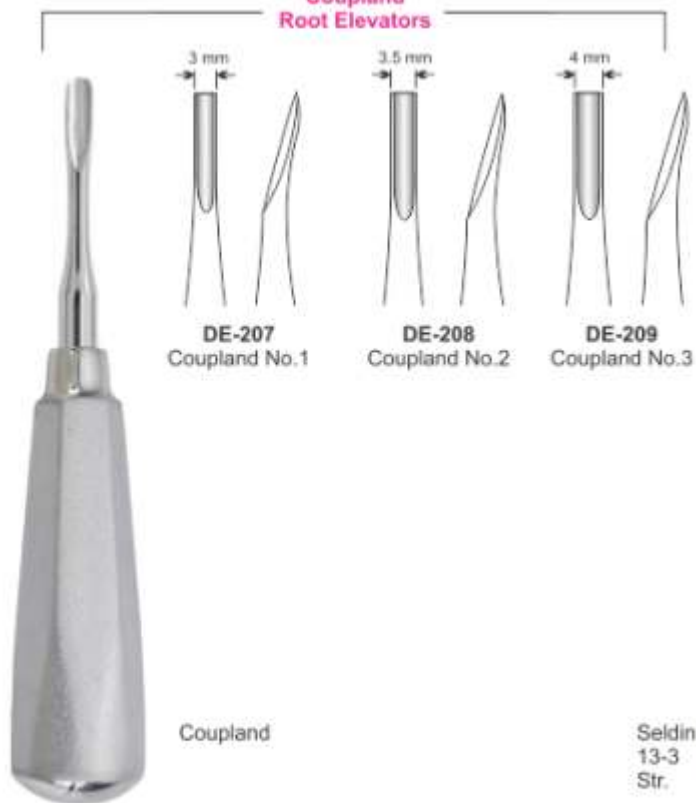

Seldin Root Elevators



ROOT ELEVATOR

- Элеватор корневой экстракционный
- Elévateurs à racines
- Wurzelheber
- Слеватор корневий екстракційний
- Elevadores para raices
- المصاعد الجذر

Apical Root Elevators

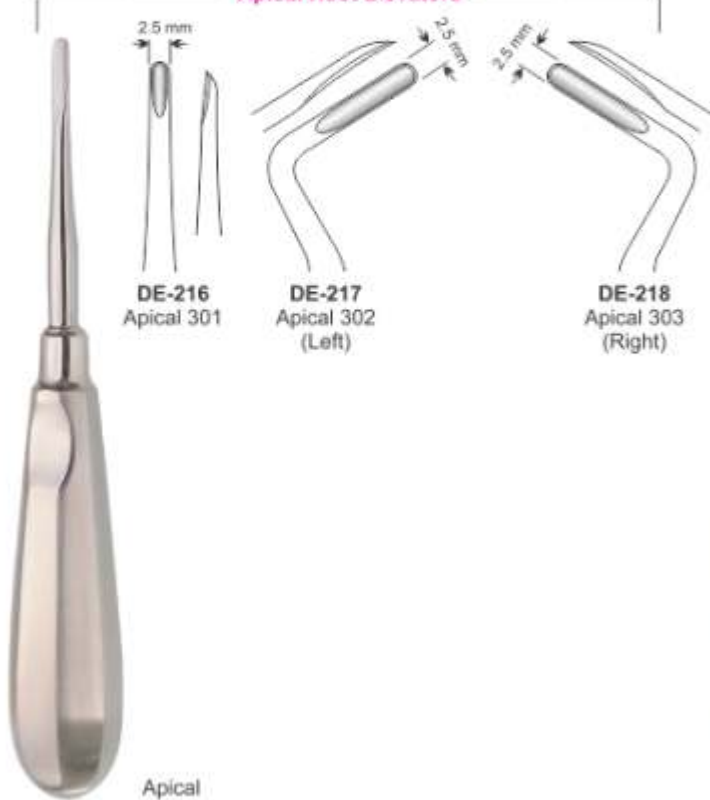

Apical Root Elevators



Apical Root Elevators



Laxutor Root Elevators

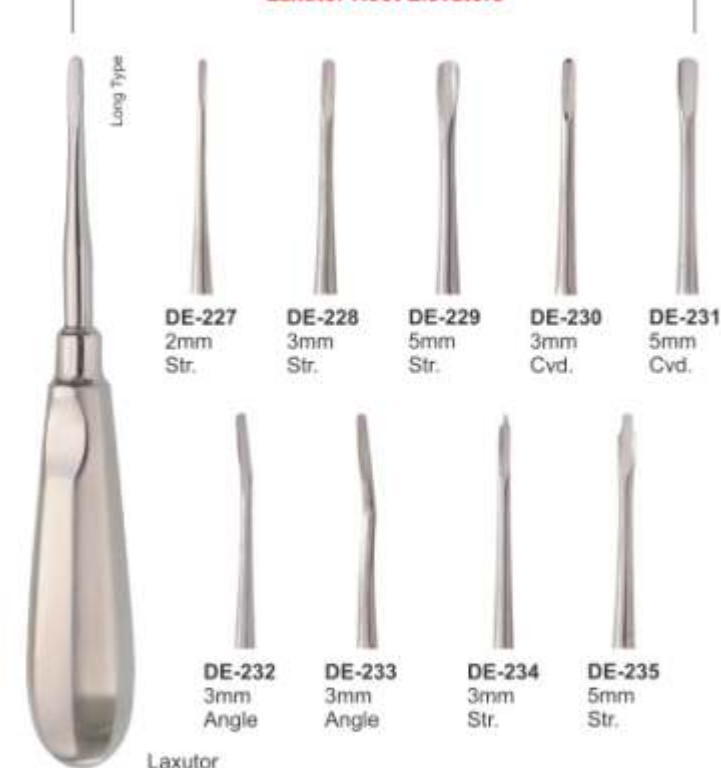

- Элеватор корневой экстракционный
- **Élévateurs à racines**
- Wurzelheber

- Elevator corneviu extracționiu
- **Elevadores para raices**
- المصاعد الجذر

Lindo Levian Root Elevators

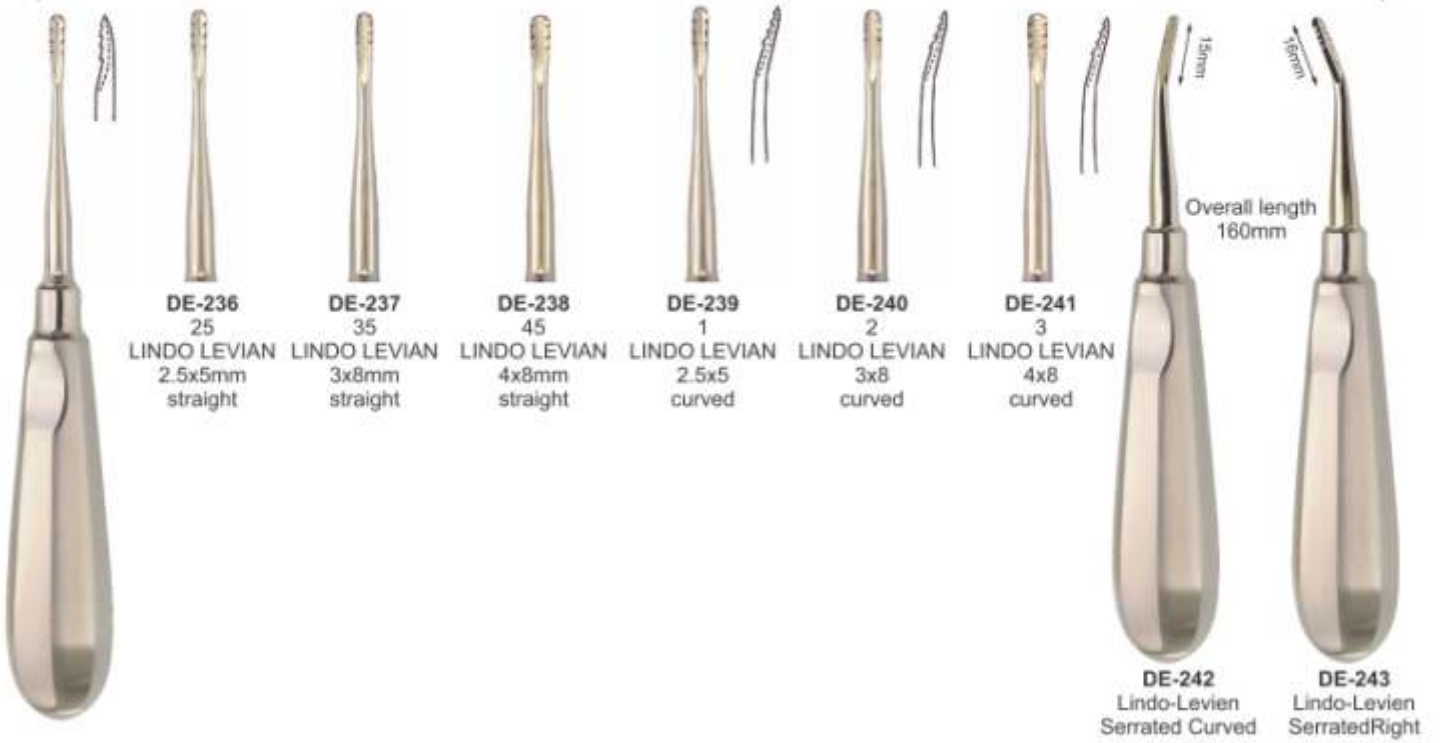

Flohr Root Elevators



Heidbrink Root Elevators

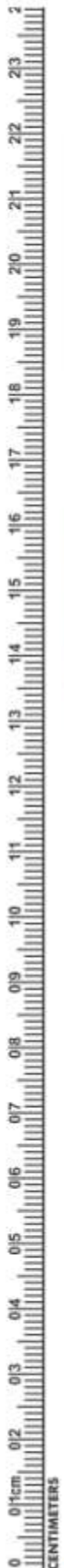
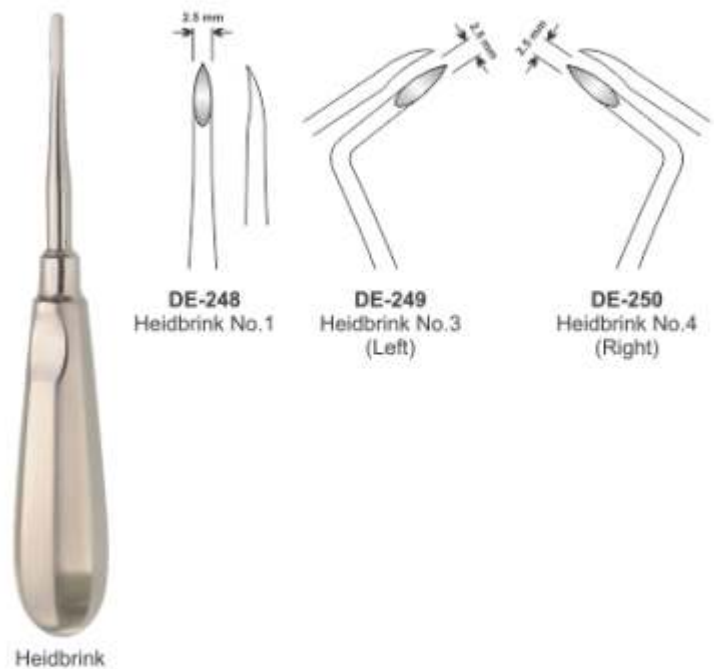

ROOT ELEVATOR

- Элеватор корневой экстракционный
- Elévateurs à racines
- Wurzelheber
- Слеватор корневий екстракційний
- Elevadores para raices
- المعاعد الجذر

Friedmann Roots Elevator



DE-251 Friedmann 4F Str.
DE-252 Friedmann 5F Left
DE-253 Friedmann 6F Right

Heidbrink Roots Elevator



DE-254 Heidbrink Straight
DE-255 Heidbrink Left
DE-256 Heidbrink Right

Wisdom Roots Elevator



DE-257 Wisdom for 18 and 38
DE-258 Wisdom for 28 and 48

Bayonet Roots Elevator Set



DE-259 Left
DE-260 Right
DE-261 bayonet
DE-262 Curved
DE-263 Straight

Luxator Roots Elevator



DE-264 Luxator Straight
DE-265 Luxator Curved



- Элеватор корневой экстракционный
- Elévateurs à racines
- Wurzelheber
- Elevator cornevee extraccionnyy
- Elevadores para raices
- المصاعد الجذر

Roots Elevator

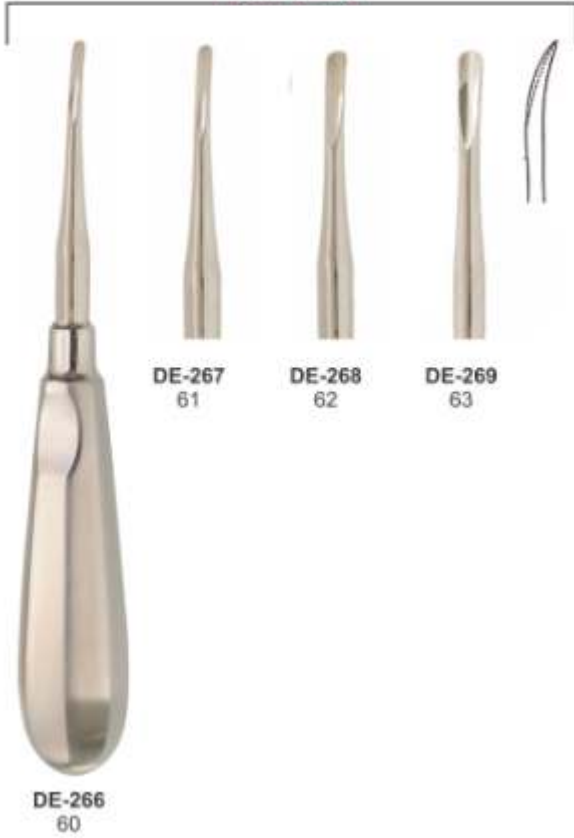

Luxier Roots Elevator

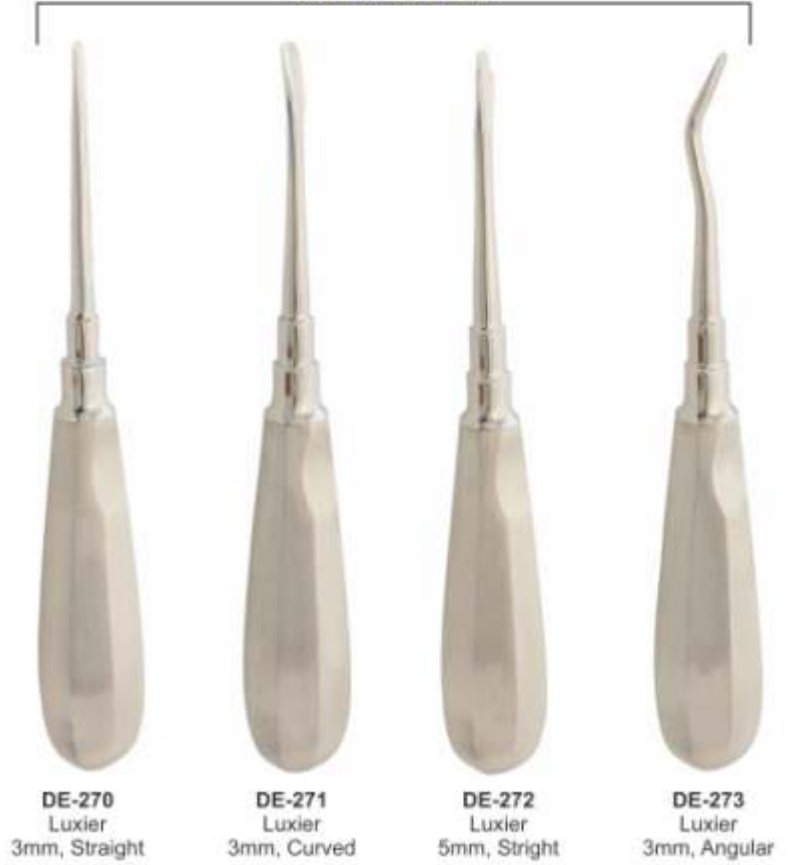

Luxier Roots Elevator

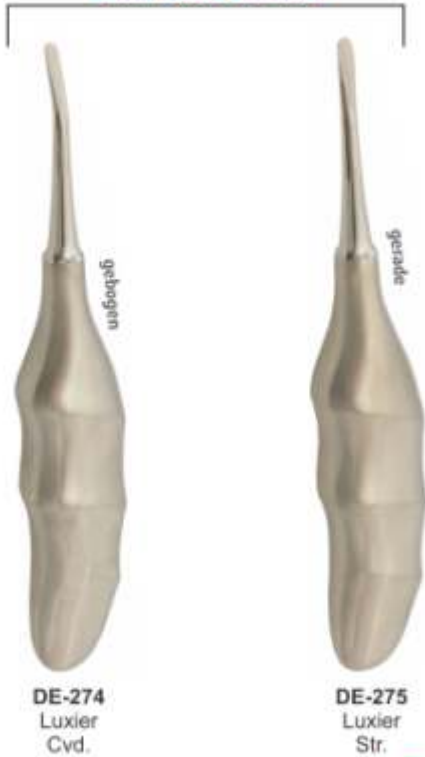

Claw-Lift Roots Elevator



ROOT ELEVATOR

- Элеватор корневой экстракционный
- Elevateurs à racines
- Wurzelheber
- Слеватор корневий екстракційний
- Elevadores para raices
- المصاعد الجذر

Hyllin Roots Elevator



Cryer Roots Elevator



Kopp Roots Elevator

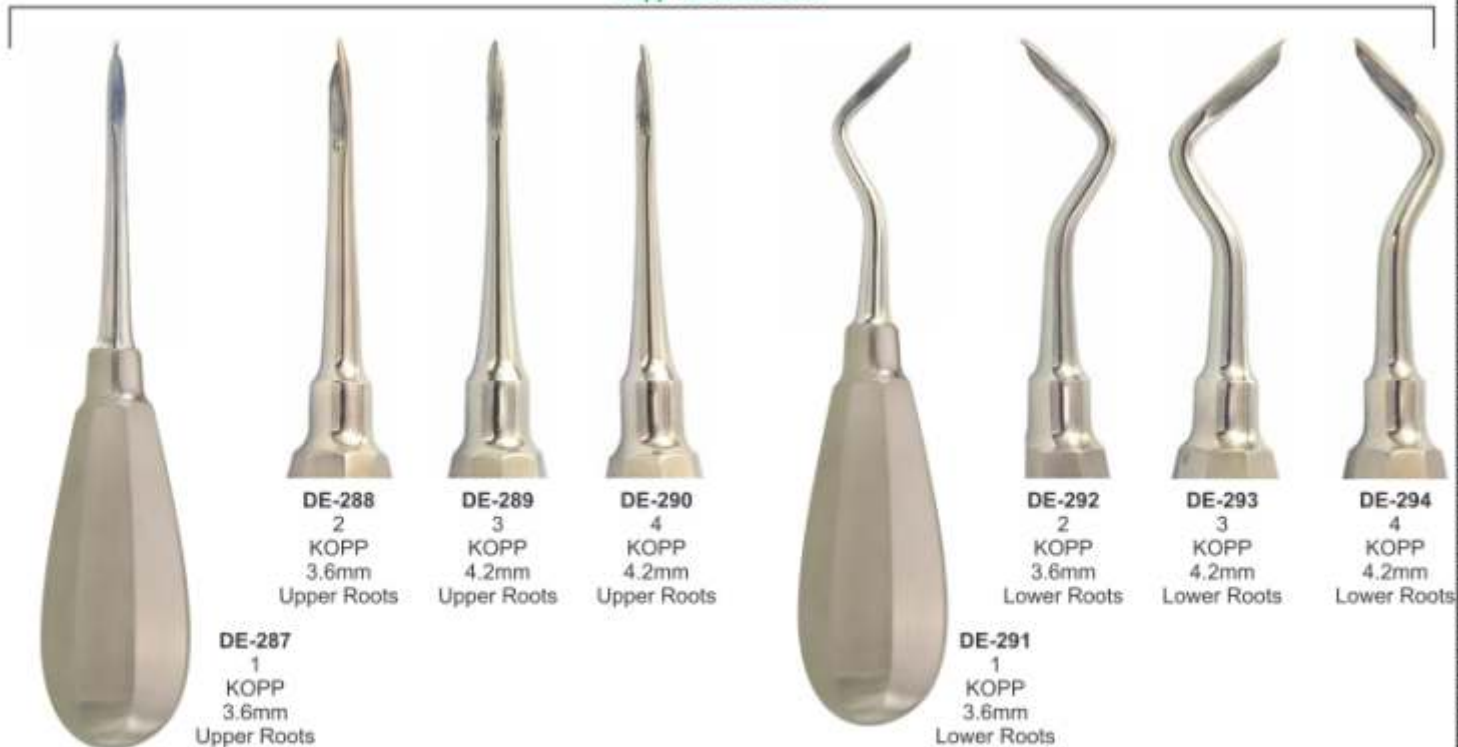

- Элеватор корневой экстракционный
- Élévateurs à racines
- Wurzelheber

- Elevadores para raíces
- المصاعد الجذر

Kopp Roots Elevator



DE-295
Kopp
Right

DE-296
Kopp
Left

Heber Roots Elevator



DE-297
Heber
Bayonet

DE-298
Heber
Bayonet

Bein Roots Elevator



DE-299
Bein,
3mm

DE-300
Bein,
4mm

Bein Roots Elevator



DE-301
Bein
2mm, curved
serrated

DE-302
2mm
straight
serrated

DE-303
3mm
straight

DE-304
4mm
Curved

DE-305
Bein
2mm, curved
serrated

DE-306
2mm
straight
serrated

DE-307
3mm
straight

DE-308
4mm
Curved

DE-309
Bein
2mm, curved
serrated

DE-310
2mm
straight
serrated

DE-311
3mm
straight

DE-312
4mm
Curved

10 01cm 0/2 0/3 0/4 0/5 0/6 0/7 0/8 0/9 0/10 0/11 0/12 0/13 0/14 0/15 0/16 0/17 0/18 0/19 0/20 0/21 0/22 0/23 2

ROOT ELEVATOR

- Элеватор корневой экстракционный
- Elévateurs à racines
- Wurzelheber
- Слеватор корневий екстракційний
- Elevadores para raices
- المصاعد الجذر

Seldin Roots Elevator



W. Barry Roots Elevator



Winter Roots Elevator



Pott Roots Elevator



- Элеватор корневой экстракционный
- Elévateurs à racines
- Wurzelheber

- Elevator cornevil extraccionny
- Elevadores para raices
- المصاعه الجذر

Heidbrink Roots Elevator



DE-338
Heidbrink
Straight

DE-339
Heidbrink
Left

DE-340
Heidbrink
Right

DE-341
Heidbrink
Straight

DE-342
Heidbrink
Left

DE-343
Heidbrink
Right

Syndesmotomes Roots Elevator



DE-344
Straight

DE-345
Left

DE-346
Right

Periotome Roots Elevator

Syndesmotomes



DE-347
Periotome
2.1mm
Straight

DE-348
Periotome
2.6mm
Straight

DE-349
Periotome
2.1mm
Angular

DE-350
Periotome
2mm
Curved

DE-351
Periotome
2.0mm

DE-352
Periotome
2.5mm

DE-353
Periotome
3.0mm

DE-354
Periotome
4.0mm

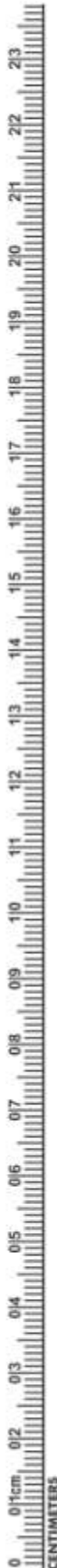

ROOT ELEVATOR

- Элеватор корневой экстракционный
- Elévateurs à racines
- Wurzelheber
- Слеватор корневий екстракційний
- Elevadores para raices
- المصاعد الجذر



DE-355
1S
(Straight 1mm)



DE-356
2S
(Straight 2mm)



DE-357
3S
(Straight 3mm)



DE-358
5S
(Straight 5mm)



DE-359
3C
(Curved 3mm)



DE-360
5C
(Curved 5mm)



DE-361
3CA
(Curved Angle 3mm)



DE-362
3IC
(Inverted Curved 3mm)



DE-363
DE 3
(Dual Edge 3mm / 1.5mm)



DE-364
DE 5
(Dual Edge 5mm / 3mm)



- Элеватор корневой экстракционный
 - **Elévateurs à racines**
 - Wurzelheber
- PDL ELEVATORS**

- **Слеватор корневий екстракційний**
- Elevadores para raíces
- المصاعد الجذر

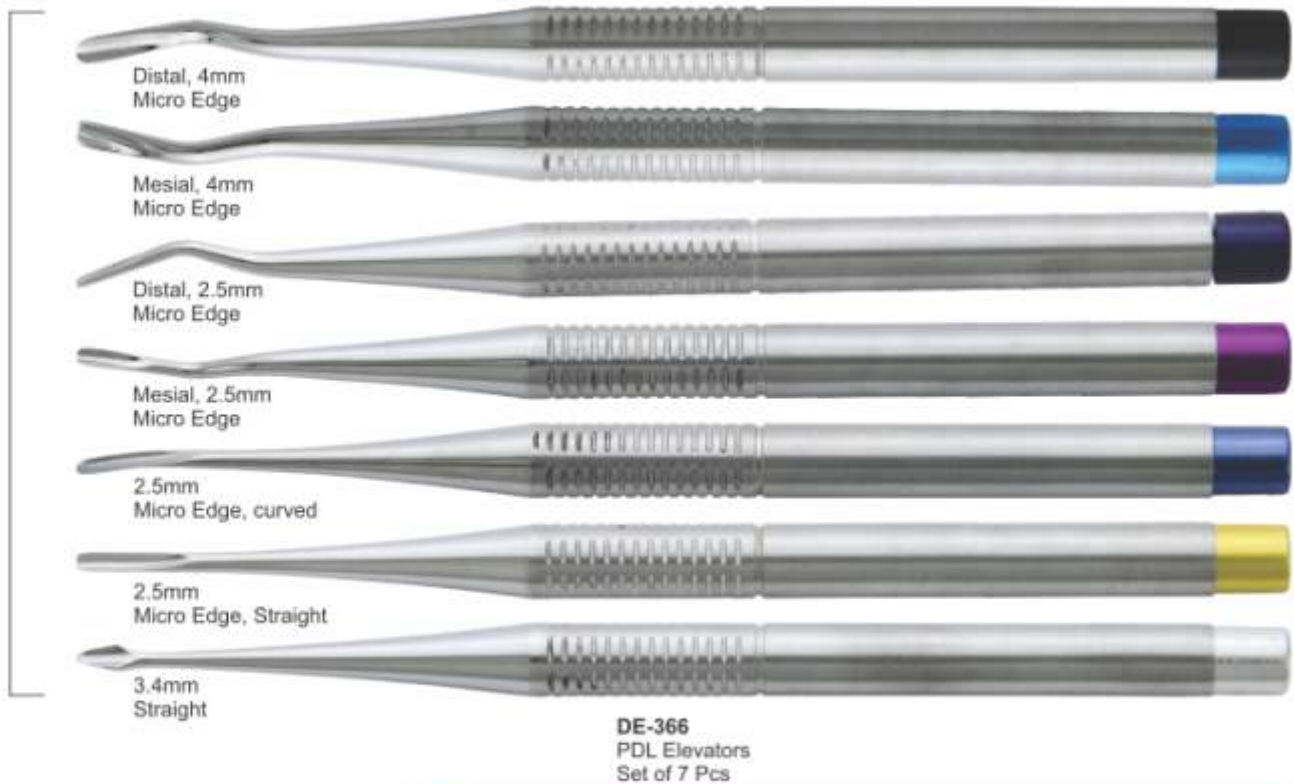
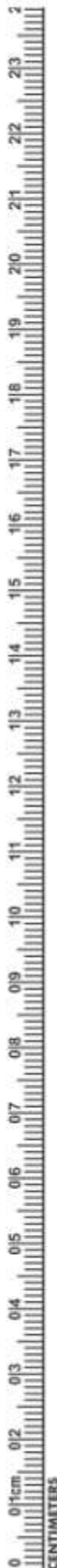

ROOT ELEVATOR

- Элеватор корневой экстракционный
- Elévateurs à racines
- Wurzelheber
- Слеватор корневий екстракційний
- Elevadores para raices
- المعاعد الجذر

PDL ELEVATORS

Delicate Arrow tip



4,0mm straight
4,0mm curved

Luxivators straight
atraumatic luxation of the tooth



2,5mm straight
3,5mm straight
4,5mm straight

Luxivators curved
atraumatic luxation of the tooth



2,5mm curved
3,5mm curved
4,5mm curved



DE-367
PDL Elevators
Set of 8 Pcs



HANDLES FOR MOUTH MIRRORS

- Ручки для зеркал
- Manches pour miroirs à bouche
- Mundspiegelgriffe
- Ручки для дзеркал
- Mangos para espejos de boca
- مقابض لمرآيا الفم

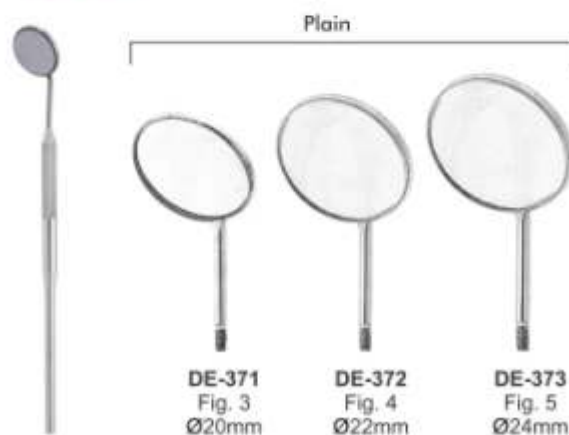
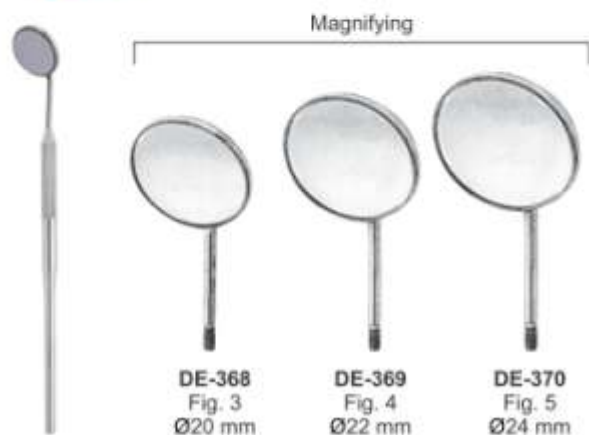

- Пинцеты
- Pincettes - Brucelles
- Zahnpinzetten

- Пинцети
- Pinzas para algodón
- זכז



DE-381
Surgical
11.5cm



DE-382
London College
15cm



DE-383
Semken Taylor
Str.



DE-384
Semken Taylor
Cvd.



DE-385
Meriam
16cm



DE-386
Dressing
14cm



DE-387
Semken Taylor
1x2 Straight



DE-388
Semken Taylor
1x2 Curved



DE-389
Gilles
15cm 1x2



DE-390
14cm 1x2



DE-391
Perry
13cm



DE-392
Atraumatic
15cm Cvd



DE-393
Atraumatic
15cm Str.



DE-394
College with Lock
15cm Cvd.



DE-395
Gerald
17.5cm



DE-396
with lock
15cm



DE-397
Atraumatic
17.5cm



TWEEZERS

- Пинцеты
- Précelles - Brucelles
- Zahnpinzetten

- Пинцети
- Pinzas para algodón
- ملقا



DE-398
Adson-TC
12cm



DE-399
Adson-TC
12cm 1x2



DE-400
Adson-TC
15cm 1x2



DE-401
Adson
12cm



DE-402
Adson
12cm 1x2



DE-403
Adson
15cm 1x2



DE-404
Adson Brown
12cm



DE-405
Crane Kaplan
15cm



DE-406
Crane Kaplan
15cm



DE-407
Crane Kaplan
15cm



DE-408
Hemingway
15cm



DE-409
Miller
15cm Str.



DE-410
Miller
15cm Cvd.



DE-411
Dressing
Tweezer
14.5cm



DE-412
College
Curved
Tip 15cm



DE-413
Maryam
Tweezers
15cm



DE-414
College
Tweezer
15cm



DE-415
Perry
Tweezer
12.5cm



DE-416
Self-locking
Tweezer
15cm



- Зонды
- Sondes
- Zahnsonden
- Зонди
- Sondas
- المستكشفين

Single Ended Probe Solid Handle 4.5mm Length 150mm

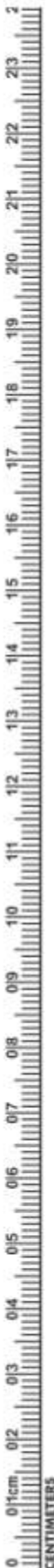

Fig. 2
Normal Handle



DE-416
Fig. 2



DE-417
Fig. 23



DE-418
Fig. 9



DE-419
Fig. 16



DE-420
Fig. 11



DE-421
Fig. 03



DE-422
Fig. 3A



DE-423
Fig. 5



DE-424
Fig. 6



DE-425
Fig. 8A



DE-426
Fig. 10



DE-427
Fig. 12



DE-428
Fig. 17



DE-429
Fig. 17A

Single Ended Probe Hollow Handle 8.5mm Length 150mm



Fig. 2
Anatomic Handle



DE-430
Fig. 2



DE-431
Fig. 23



DE-432
Fig. 9



DE-433
Fig. 16



DE-434
Fig. 11



DE-435
Fig. 03



DE-436
Fig. 3A



DE-437
Fig. 5



DE-438
Fig. 6



DE-439
Fig. 8



DE-440
Fig. 8A



DE-441
Fig. 10



DE-442
Fig. 12



DE-443
Fig. 17



DE-444
Fig. 17A

EXPLORERS

- Зонды
- Sondes
- Zahnsonden
- Зонди
- Sondas
- المستكشفين

Probes Single End Solid Handle 6mm, length 150mm



DE-445 Fig. 6 DE-446 Fig. 8 DE-447 Fig. 9 DE-448 Fig. 16 DE-449 Fig. 23

Probes Single Ended 6mm, length 150mm

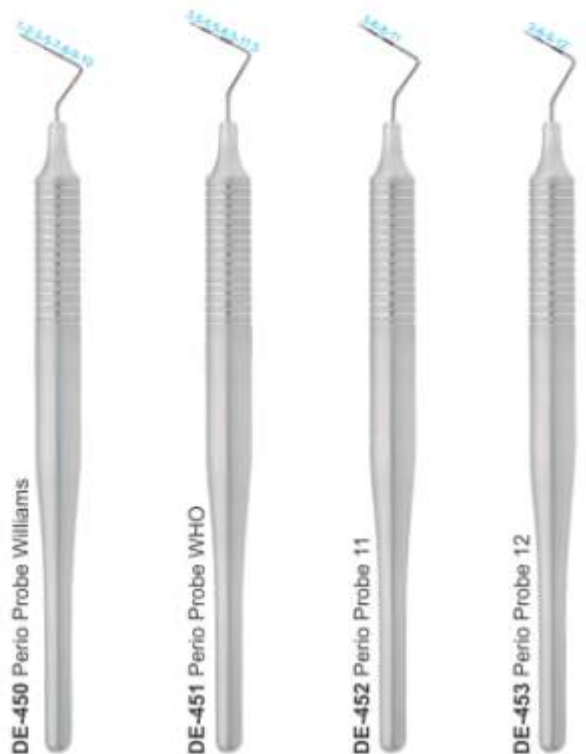

DE-450 Perio Probe Williams DE-451 Perio Probe WHO DE-452 Perio Probe 11 DE-453 Perio Probe 12

Examination kit Set of 3 Pieces



DE-454 Probe DE-455 Mirror DE-456 College Forcep 15cm

Examination Set of 4 Pieces



Examination Set of 4 Pieces



DE-457 Exp,23/17-A DE-458 Exavators DE-459 Tweezers DE-460 Mouth Mirror



- Зонды
- Зонди
- Sondas
- Sondas
- Zahnsonden
- المستكشفين

EXPLORERS INSTRUMENTS SOLID HANDLE 6MM, LENGTH 170MM



Explorers-Single-End



DE-461
23
Shepherd's
Hook
Explorer
#30, #6, #7, #8

Double-Ended Explorers

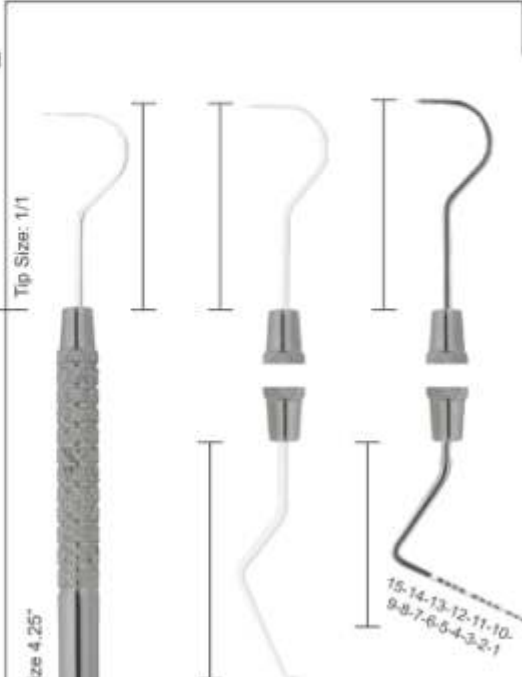

Tip Size: 1/1

Solid Handle Size 4.25"

DE-463
TU 17/23
Wilkins/Tufts
Explorer
#6

DE-464
23/UNC1
university of north
carolina
Explorer #31, #6, #7, #8

DE-465
1
#31, #6

DE-466
DG 16
#31, #6, #7
Thick, #6

DE-467
DG 16/23

DE-468
DG 16/17

DE-469
1
Abou-Rass
Explorers

15-14-13-12-11-10-
9-8-7-6-5-4-3-2-1

EXPLORERS

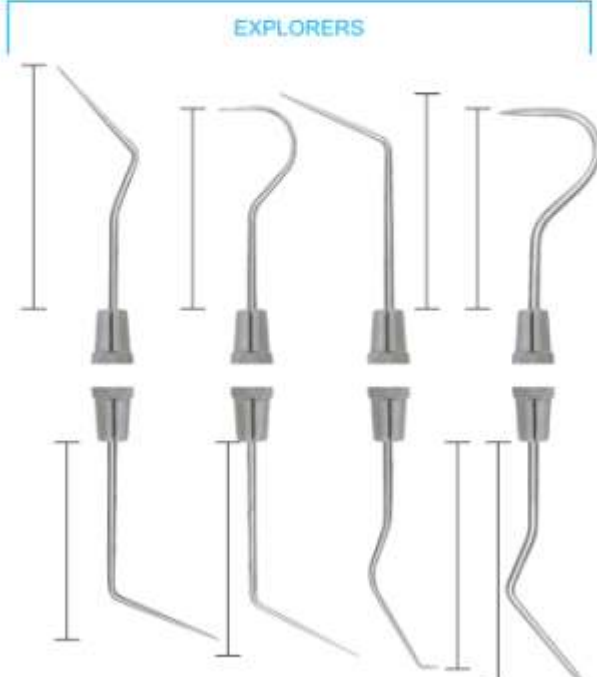

Probes Double Ended 6mm, length 170mm



DE-470
Goldman Fox
Fig.17

DE-471
University
of Michigan
Fig.17

DE-472
Williams
Fig.17

DE-473
Goldman Fox
Fig.16

DE-474
University
of Michigan
Fig.16

DE-475
Williams
Fig.16

EXPLORERS

- Зонды
- Sondes
- Zahnsonden
- Зонди
- Sondas
- المستكشفين

Pointed Probes Single Ended Handle 6mm, length 150mm



Pointed Probes Double Ended Handle 6mm, length 170mm



- Инструменты пародонтологические
- Instruments pour la parodontologie
- Instrumente für die Parodontologie

- Инструменти пародонтологічні
- Instrumentos para periodoncia
- الصكوك اللثة

PERIODONTAL SET OF 10 PIECES SOLID HANDLE 6MM LENGTH 170MM

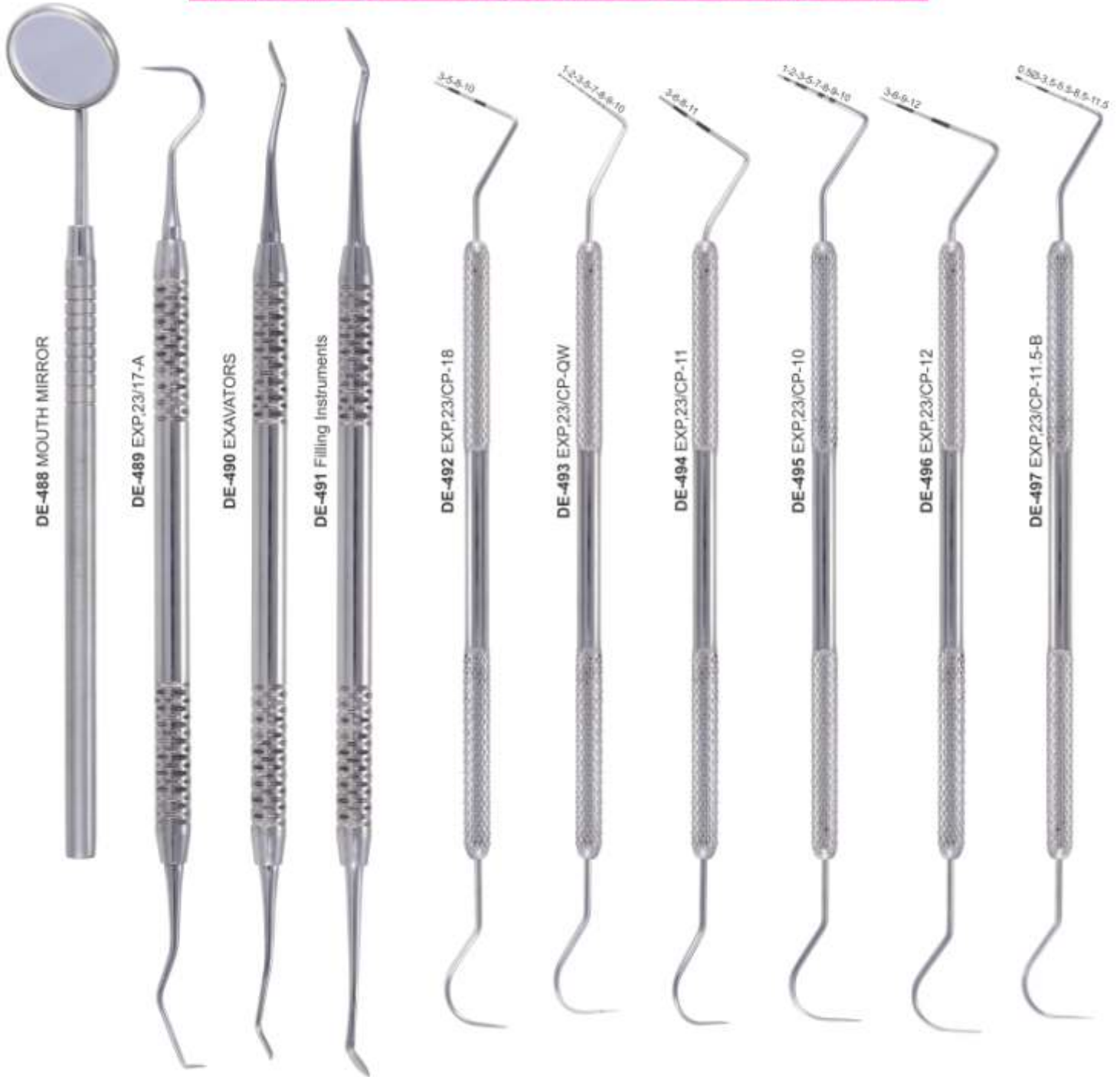

EXPLORERS

- Зонды
- Sondes
- Zahnsonden
- Зонди
- Sondas
- المستكشفين

WILLIAM PROBE SET DOUBLE ENDED WITH HOLLOW HANDLE 9.5MM, LENGTH 170MM
CERAMIC COATED HANDLE

Proper care must be given during cleaning, sharpening and sterilization to preserve design and integrity and to prolong usefulness. Do not expose instruments to sterilization temperatures above 350 F/177 C or to higher than recommended chemical concentrations.

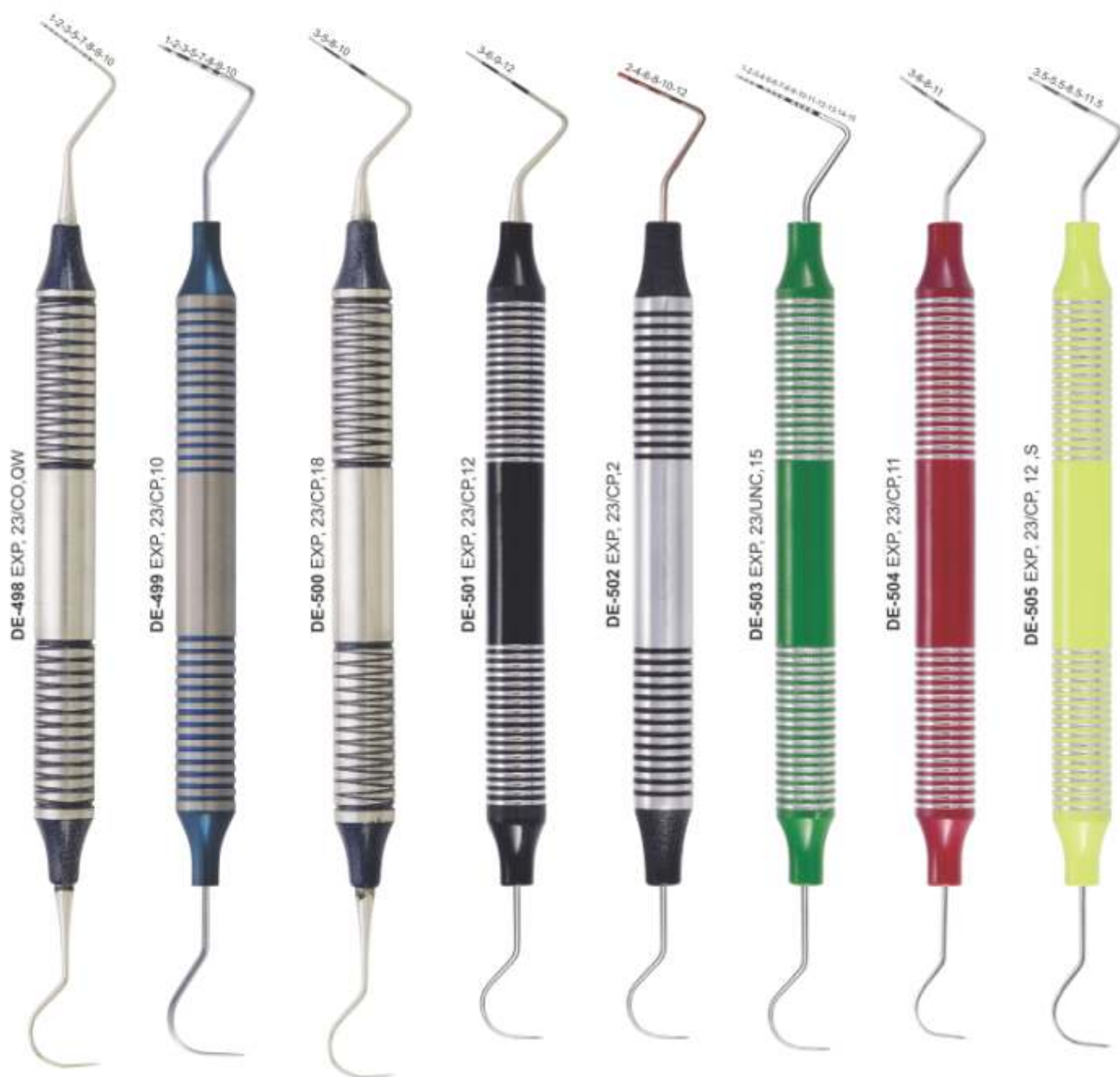

- Инструменты пародонтологические
- Instruments pour la parodontologie
- Instrumente für die Parodontologie

- Інструменти пародонтологічні
- Instrumentos para periodoncia
- الصكوك اللثة

**PERIODONTAL INSTRUMENTS SET OF 11 PCS
SOLID HANDLE 6MM, LENGTH 170MM**



CURETTES

- Кюрети
- Curetas
- Küretten
- Кюрети
- Curette
- كرتس

GRACEY SET OF 7 PCS HOLLOW HANDLE 9.5MM, LENGTH 170MM

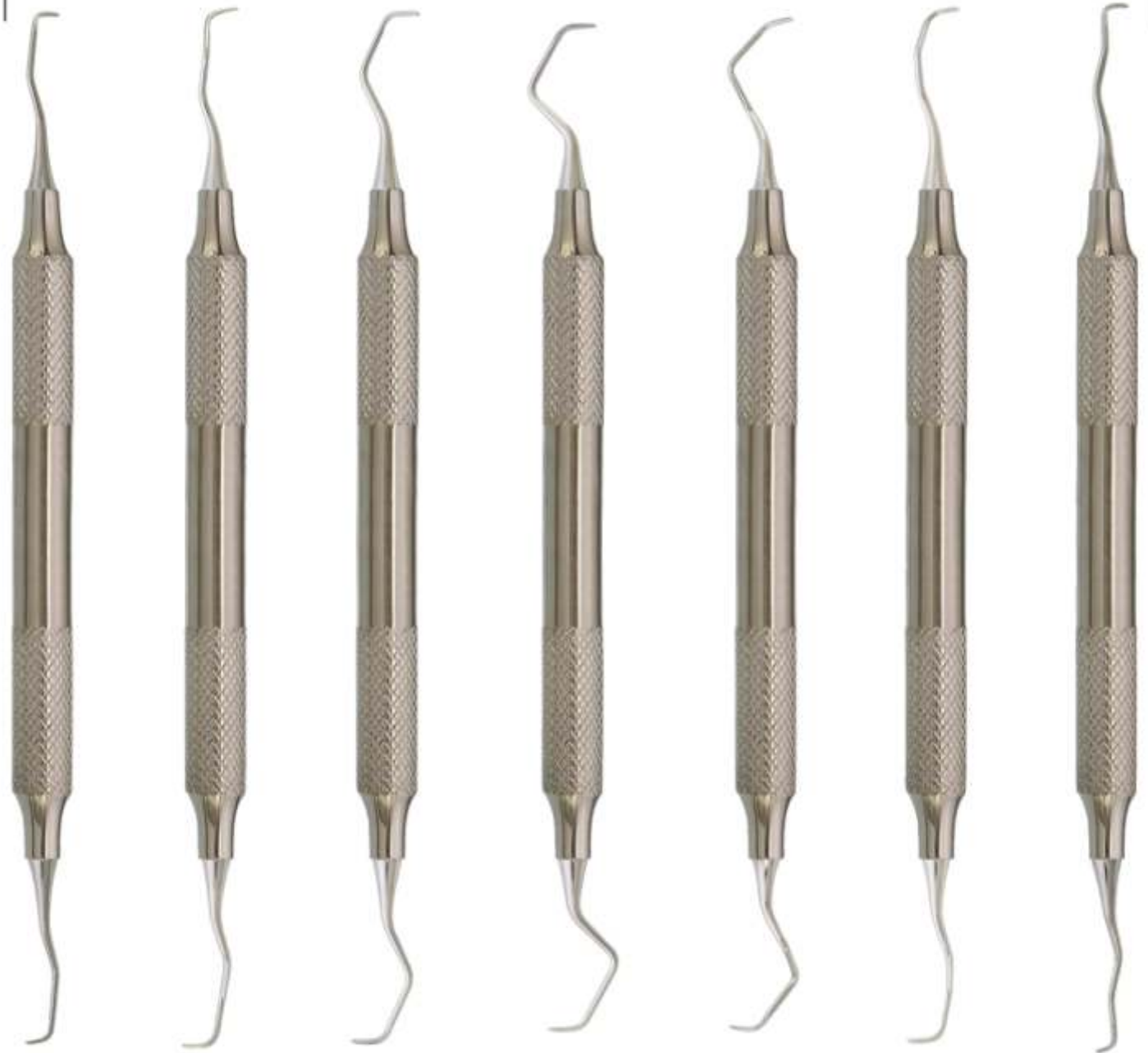

DE-517
GRACEY
1/2

DE-518
GRACEY
3/4

DE-519
GRACEY
5/6

DE-520
GRACEY
7/8

DE-521
GRACEY
9/10

DE-522
GRACEY
11/12

DE-523
GRACEY
13/14

INCHES
19
18
17
16
15
14
13
12
11
10

- Кюрети
- Curetas
- Küretten
- Кюрети
- Curette
- كرتس

GRACEY SET OF 7 PCS
HOLLOW HANDLE 9.5MM, LENGTH 170MM WITH SILICON GRIP

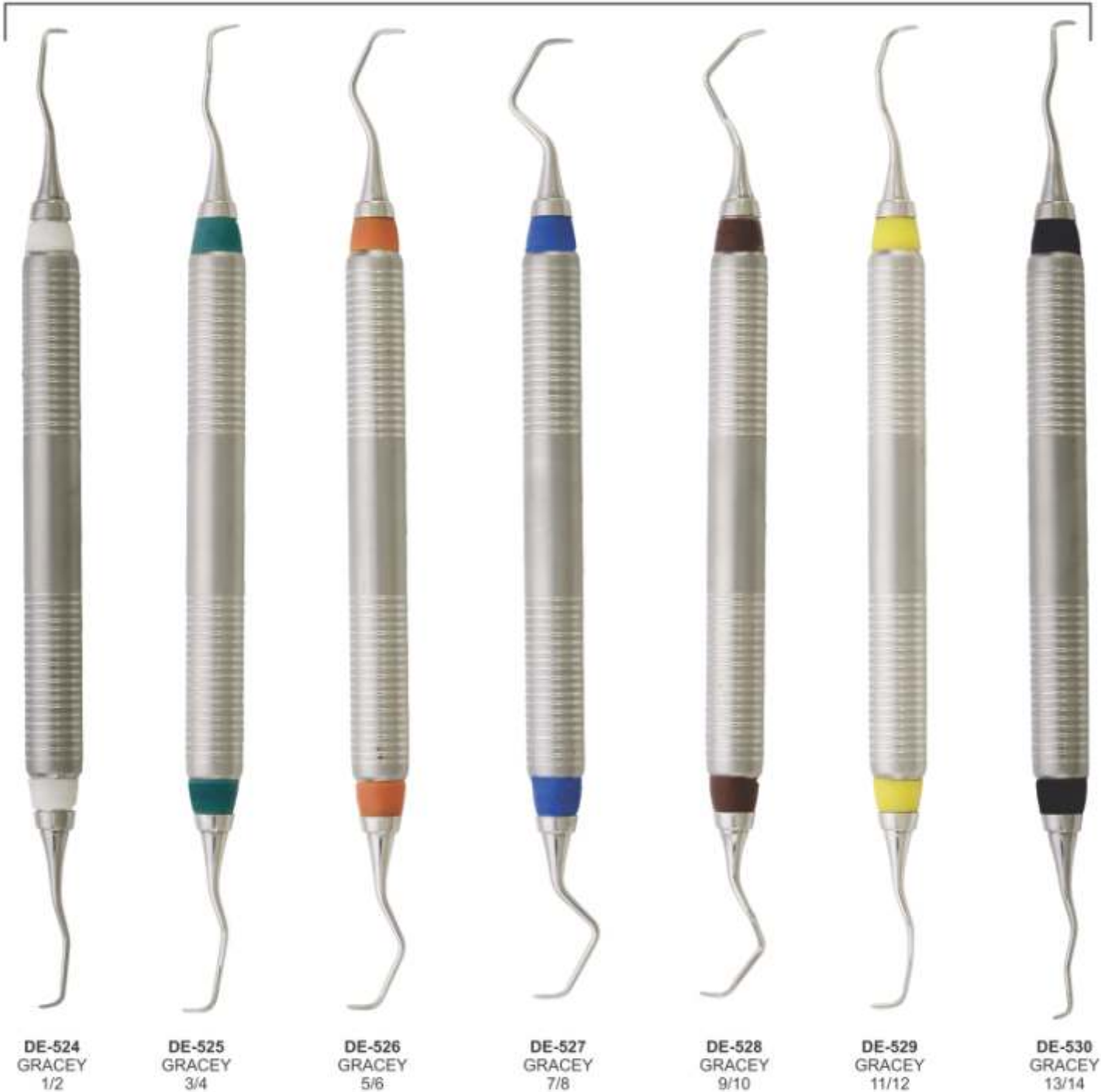
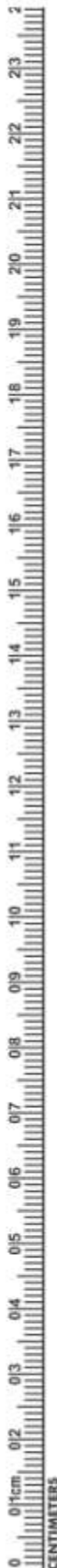

DE-524
GRACEY
1/2

DE-525
GRACEY
3/4

DE-526
GRACEY
5/6

DE-527
GRACEY
7/8

DE-528
GRACEY
9/10

DE-529
GRACEY
11/12

DE-530
GRACEY
13/14

CURETTES

- Кюрети
- Curetas
- Küretten
- Кюрети
- Curette
- كرتس

GRACEY MINI FIVE

HOLLOW HANDLE 9.5MM, LENGTH 170MM
CERAMIC COATED HANDLE



DE-531	DE-532	DE-533	DE-534	DE-535	DE-536
Gracey	Gracey	Gracey	Gracey	Gracey	Gracey
1/2	3/4	5/6	7/8	11/12	13/14

GRACEY AFTER FIVE

HOLLOW HANDLE 9.5MM, LENGTH 170MM
CERAMIC COATED HANDLE



DE-537	DE-538	DE-539	DE-540	DE-541	DE-542
Gracey	Gracey	Gracey	Gracey	Gracey	Gracey
1/2 AF	3/4 AF	5/6 AF	7/8 AF	11/12 AF	13/14 AF

Proper care must be given during cleaning, sharpening and sterilization to preserve design and integrity and to prolong usefulness. Do not expose instruments to sterilization temperatures above 350 F/177 C or to higher than recommended chemical concentrations.



- Кюрети
 - Curetas
 - Küretten
- Кюрети
 - Curette
 - كرتس

GRACEY CURETTE HOLLOW HANDLE 10MM, LENGTH 170MM

Curetters Set of 8 Pieces

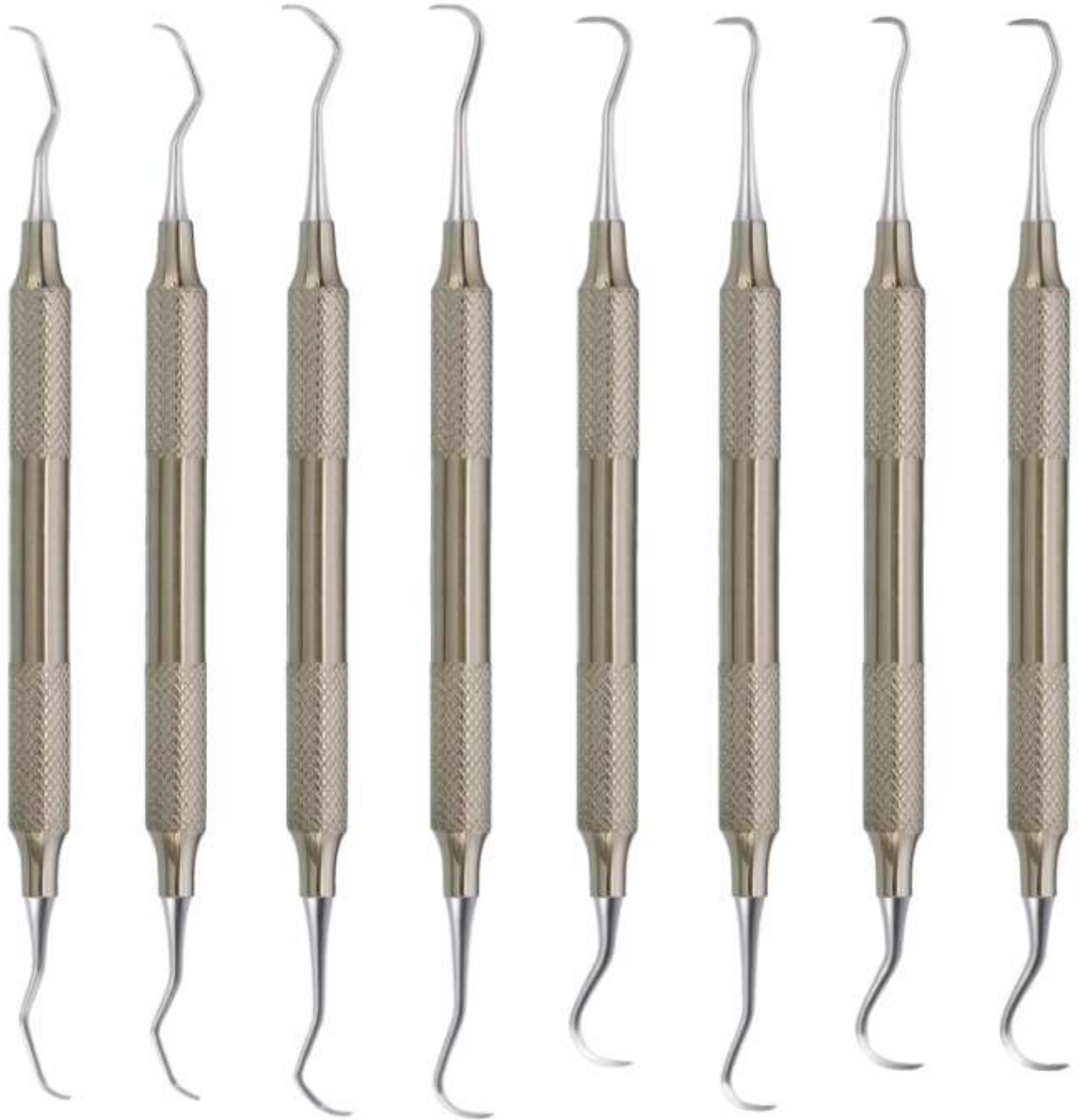

DE-543
Curette
Columbia
2L-2R

DE-544
Curette
Columbia
4L-4R

DE-545
Curette
McCall
13S-14S

DE-546
H6-H7
Scaler
Sickle

DE-547
H5-U15
Scaler
Sickle

DE-548
H5-13
Scaler
Sickle

DE-549
U15-30
Scaler
Sickle

DE-550
U15-33
Scaler
Sickle

FILLING INSTRUMENTS

- Инструменты для реставрации
- Instruments pour plombage
- Füllungsinstrumente (mit Kontrawinkel)
- Инструменти для реставрації
- Instrumentos para obturaciones
- ملء الصكوك

**FILLING INSTRUMENTS (Gold Pointed)
SOLID HANDLE 6MM, LENGTH 170MM**



Solid Handle Size 4.25"

Tip Size: 1/1

DE-551 1.5mm / 1.5mm
DE-552 2.0mm / 2.0mm
DE-553 2.0mm / 2.0mm

DE-554 2.5mm / 2.5mm

DE-555 1.3mm / 0.9mm
DE-556 1.6mm / 1.3mm
DE-557 2.4mm / 1.8mm

DE-558 2.4mm / 2.0mm
DE-559 1.3mm / 1.5mm
DE-560 1.8mm / 1.2mm

Filling instrument, spatula 6 mm solid handle, length 170 mm,

Filling instrument 6 mm length 175 mm,

Filling instrument, ball 6 mm length 170 mm,

Filling instrument, ball / spatula 6 mm length 175 mm,















Filling instrument, plan / plan 6 mm length 165 mm,

**EXPLORERS INSTRUMENTS
SOLID HANDLE 6MM, LENGTH 170MM**

- Зонды
- Зонди
- Sondes
- Sondas
- Zahnsonden
- المستكشفين



PLUGGERS

.50	1.00	.50	.80
			
			
.75	1.15	.60	1.10
DE-562 5/7 21mm	DE-563 9/11 21mm	DE-564 1/2 Root Canal Plugger	DE-565 3/4 Root Canal Plugger
		.20	.25
			
		DE-566 MA57 27mm	DE-567 GP3 30mm
.30	.40	.50	.60
			
DE-568 ISO Size 30 24mm	DE-569 ISO Size 40 24mm	DE-570 ISO Size 50 24mm	DE-571 ISO Size 60 24mm

PERIODONTAL PROBES

- Зонды пародонтологические
- Sondes parodontales
- sonde parodontali
- зонди пародонтологічні
- Sondas parodontales
- المسابر اللثة

SPREADERS

HEAT CARRIERS

Tip Size: 1/1

Solid Handle Size 4.25"

Model	ISO / Standard	Tip Size	Length
DE-572	ISO Size 30	.30	24mm
DE-573	ISO Size 40	.40	24mm
DE-574	ISO Size 50	.50	28mm
DE-575	ISO Size 60	.60	28mm
DE-576	GP1	.25	20mm
DE-577	1S Wakai	.30	22mm
DE-578	2S Wakai	.40	22mm
DE-579	D11 Standard	.40	23mm
DE-580	D11S Thin	.35	23mm
DE-581	D11T Thinner	.23	22mm
DE-582	D11TS Thinnest	.20	21mm
DE-583	3	.35	28mm
DE-584	GP2	.25	25mm
DE-585	0‡	.35	25mm
DE-586	00‡	.55	25mm

INCHES

- Зонды пародонтологические
 - Sondes paradontales
 - sonda parodontali
- зонди пародонтологични
 - Sondas paradontales
 - المسبار اللثة

ENDODONTICS INSTRUMENTS

ANTERIOR



DE-587
8A
29mm

DE-588
8 1/2A
29mm

DE-589
9A
29mm

DE-590
9 1/2A
29mm

DE-591
10A
29mm

DE-592
10 1/2A
29mm

DE-593
11A
29mm

DE-594
11 1/2A
29mm

DE-595
12A
29mm

LUKS



DE-596
L1
18mm

DE-597
L2
18mm

DE-598
L3
18mm

DE-599
L4
18mm

PERIODONTAL PROBES

- Зонды пародонтологические
- Sondes paradontales
- sonda paradontali
- зонди пародонтологічні
- Sondas paradontales
- المساطر اللثة

ENDODONTICS INSTRUMENTS SOLID HANDLE 6MM, LENGTH 170MM

POSTERIOR

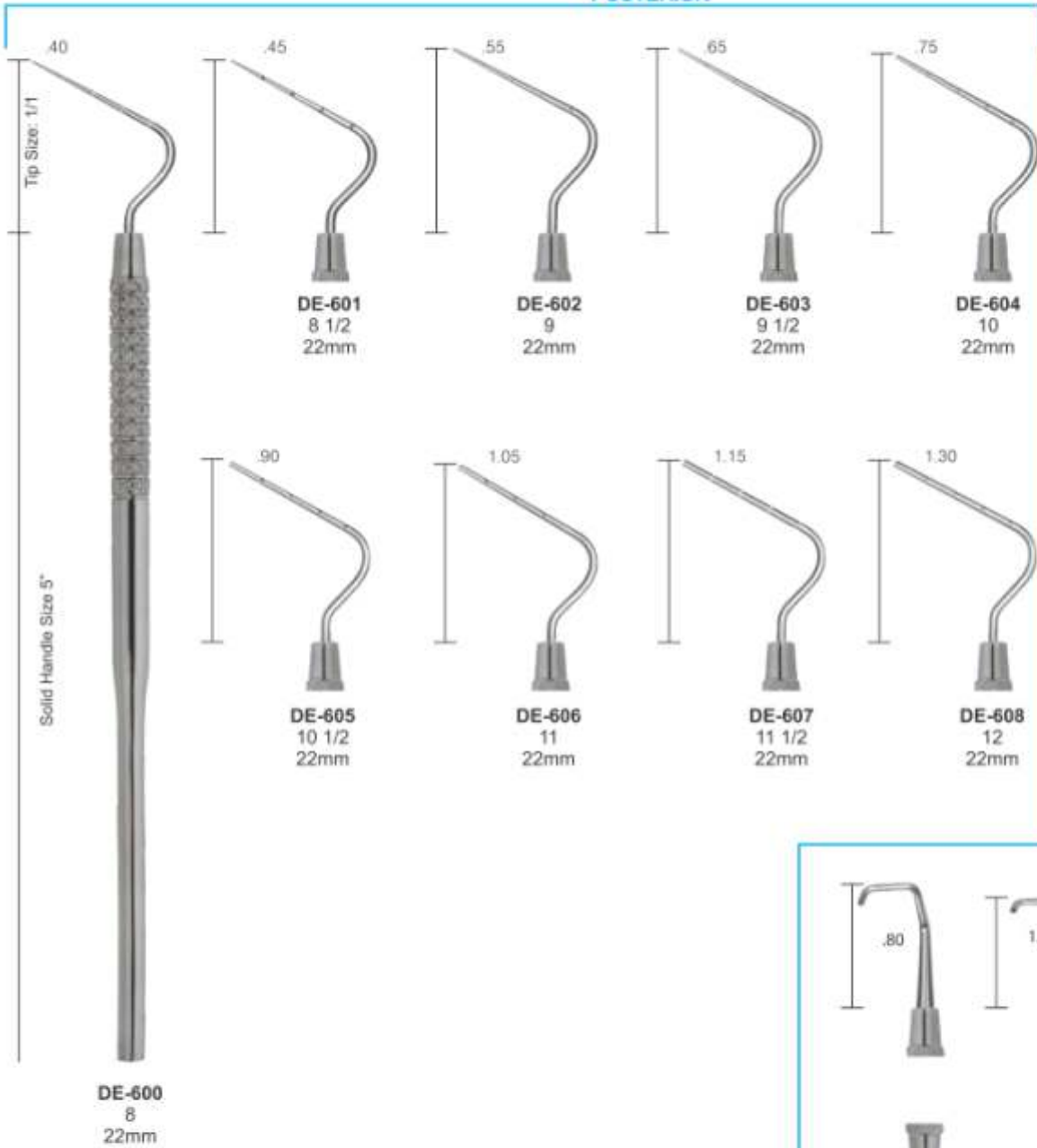

RETRO FILLING PLUGGERS

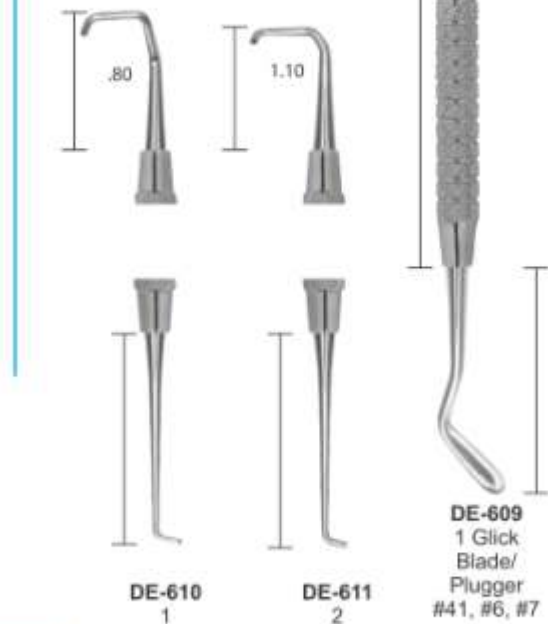

- Инструменты для реставрации
- Instruments pour plombage
- Füllungsinstrumente (mit Kontrawinkel)

- Инструменти для реставрації
- Instrumentos para obturaciones
- ملء الصلوك

COMPOSITE/PLASTIC FILLING INSTRUMENTS SOLID HANDLE 6MM, LENGTH 170MM

POSTERIOR

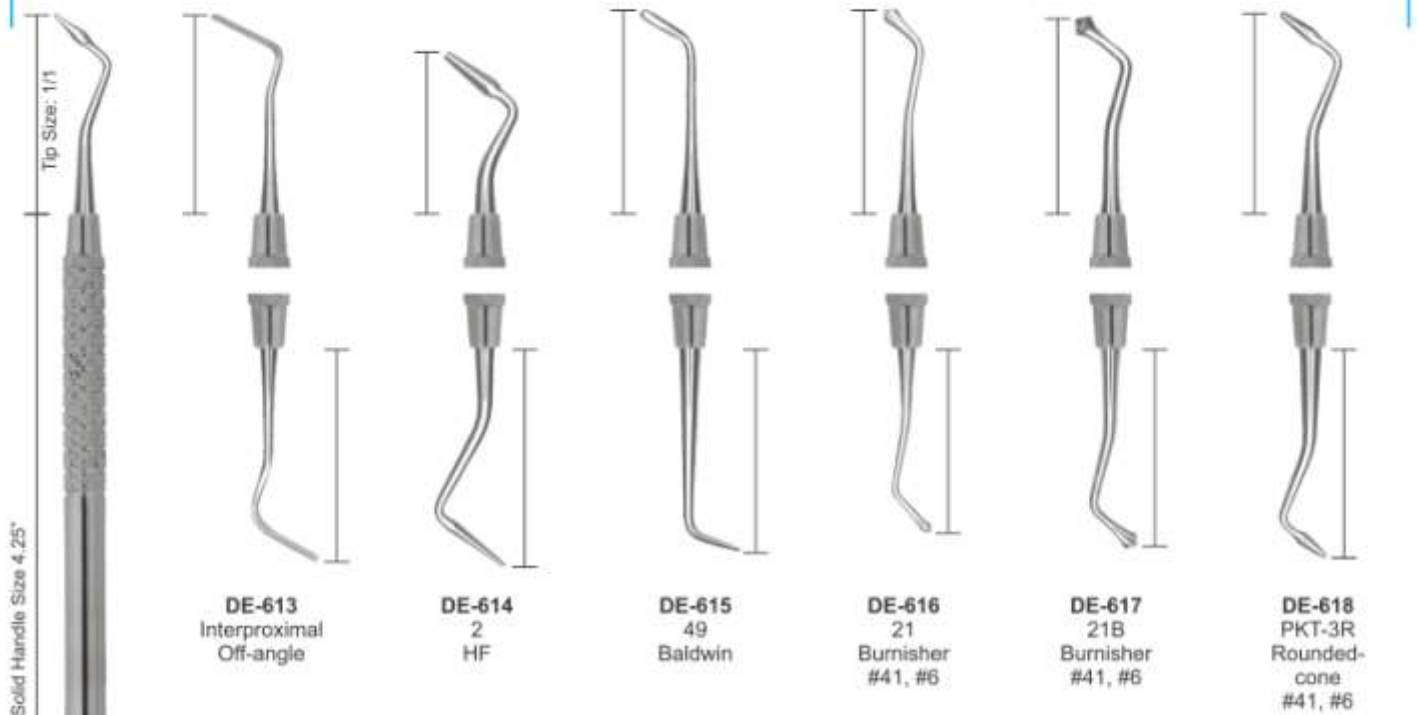

UNIVERSAL FILLING INSTRUMENTS

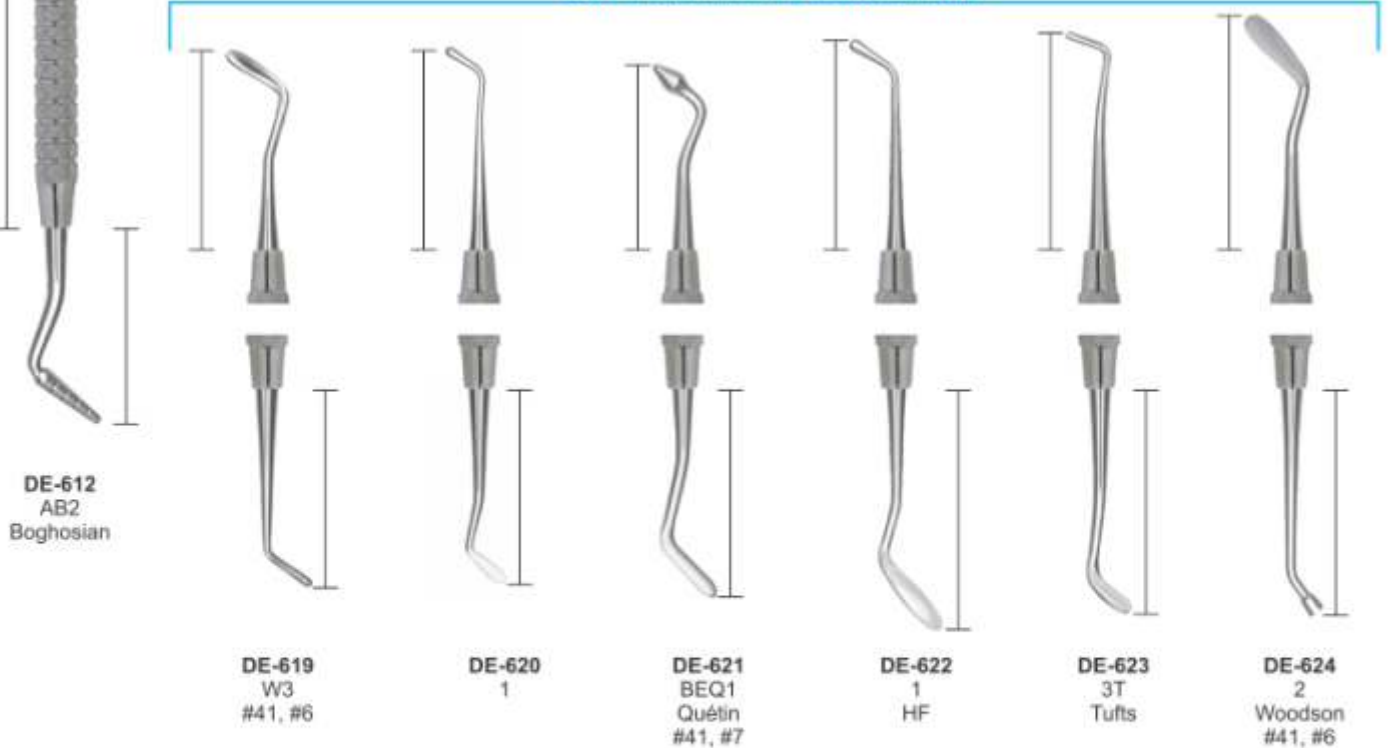

FILLING INSTRUMENTS

- Инструменты для реставрации
- Instruments pour plombage
- Füllungsinstrumente (mit Kontrawinkel)
- Инструменти для реставрації
- Instrumentos para obturaciones
- ملء الصكوك

COMPOSITE/PLASTIC FILLING INSTRUMENTS SOLID HANDLE 6MM, LENGTH 170MM

BLACK

PLUGGERS/CONDENSERS

Hollenback

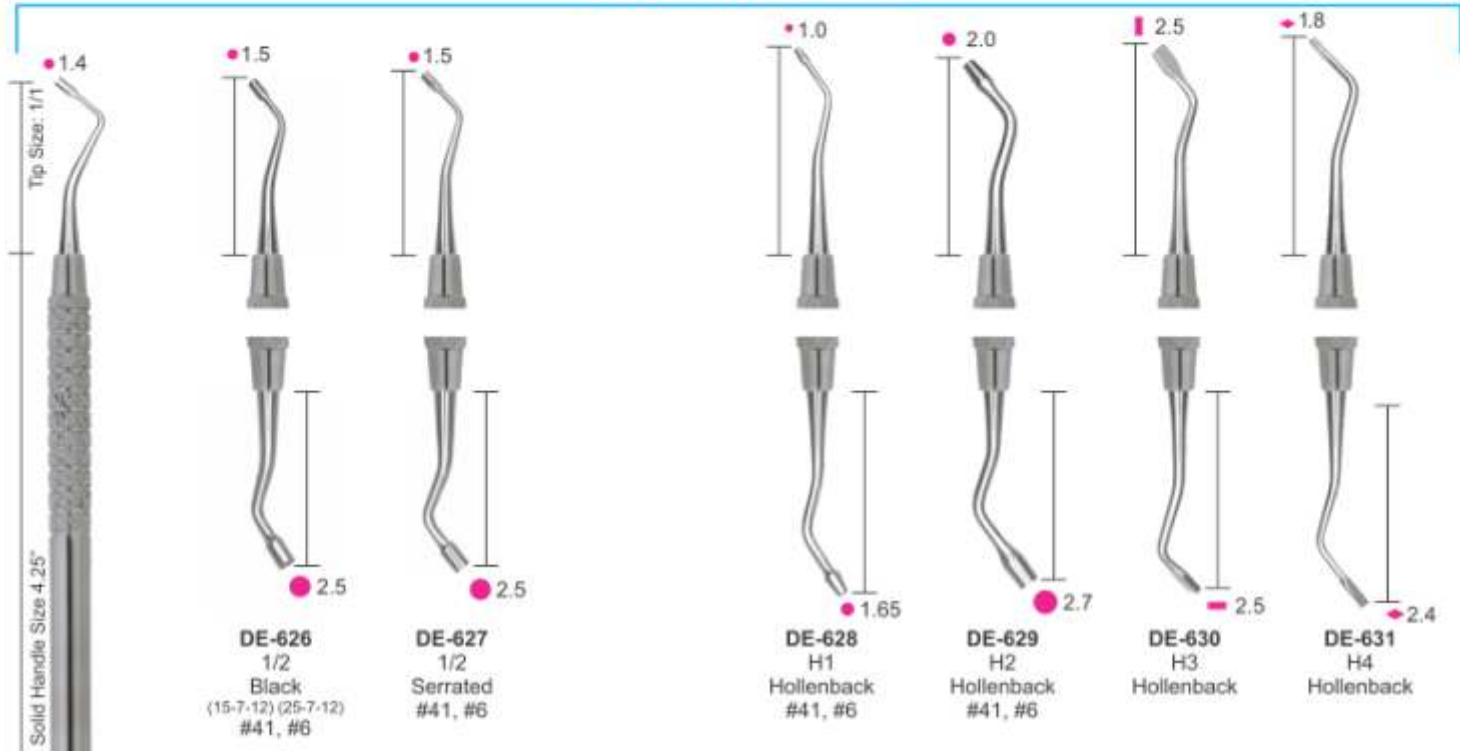

MARQUETTE CONDENSER

MORTONSON

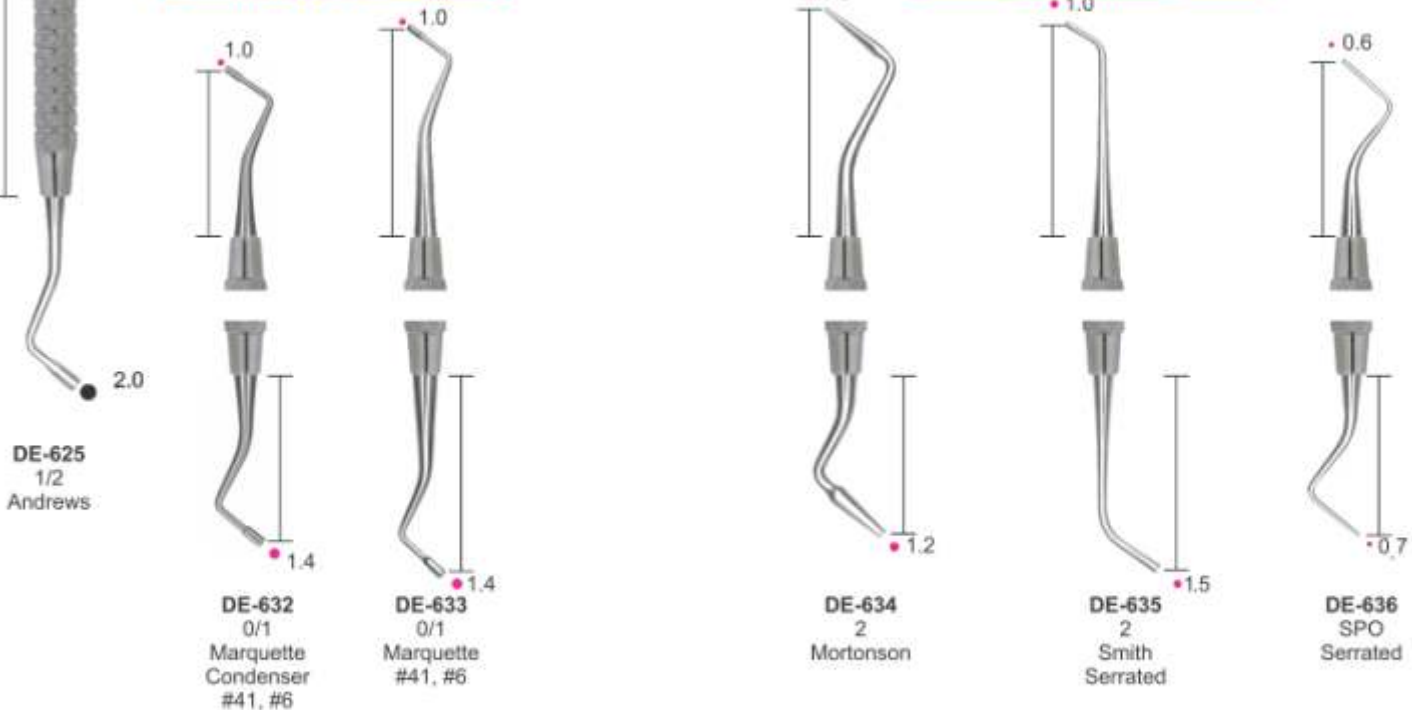

- Инструменты для реставрации
- Instruments pour plombage
- Füllungsinstrumente (mit Kontrawinkel)
- Инструменти для реставрації
- Instrumentos para obturaciones
- ملء الصلوك

PLUGGERS/CONDENSERS

RESTORATIVE INSTRUMENTS SOLID HANDLE 6MM, LENGTH 170MM



DE-638
2M
Markley

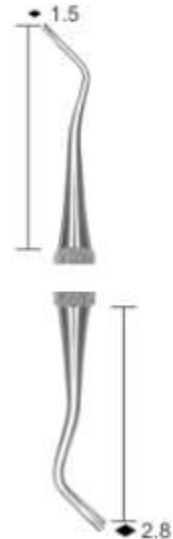

DE-639
4M
Markley

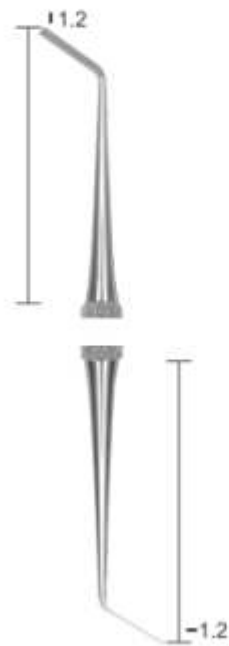

DE-640
5M
Markley

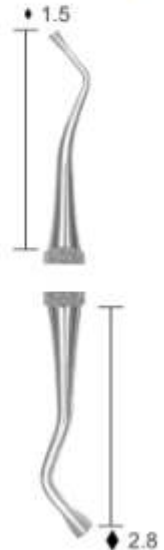

DE-641
6M
Markley

PLUGGERS/CONDENSERS



DE-642
1
Oregon
#41, #6



DE-643
2
Oregon
#41, #6



DE-644
3
Oregon



DE-645
4
Oregon
#41, #6

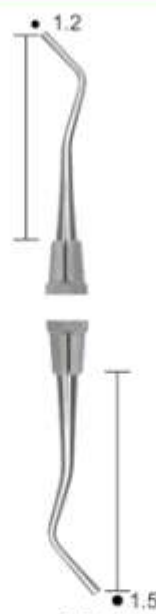

DE-646
1
Ward



DE-647
2
Ward

DE-637
1M
Markley

FILLING INSTRUMENTS

- Инструменты для реставрации
- Instruments pour plombage
- Füllungsinstrumente (mit Kontrawinkel)
- Инструменти для реставрації
- Instrumentos para obturaciones
- ملء الصكوك

RESTORATIVE INSTRUMENTS SOLID HANDLE 6MM, LENGTH 170MM

Tanner Filling Instruments

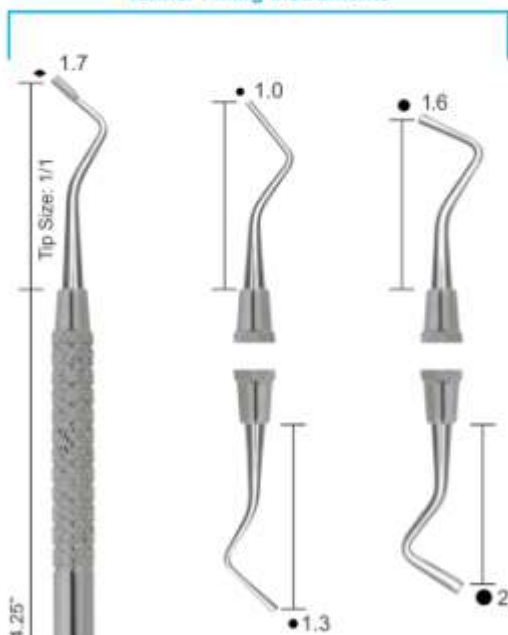

DE-649
2T
Tanner



DE-650
3T
Tanner



DE-651
9/10
Back Action



DE-652
11/12
Back Action



DE-653
153
English Pattern
Serrated



DE-654
153
English Pattern
Serrated

• 1.3

• 2.0

• 1.6

• 2.5

• 2.4

Solid Handle Size 4.25"

Tip Size: 1/1

BURNISHERS

BALL

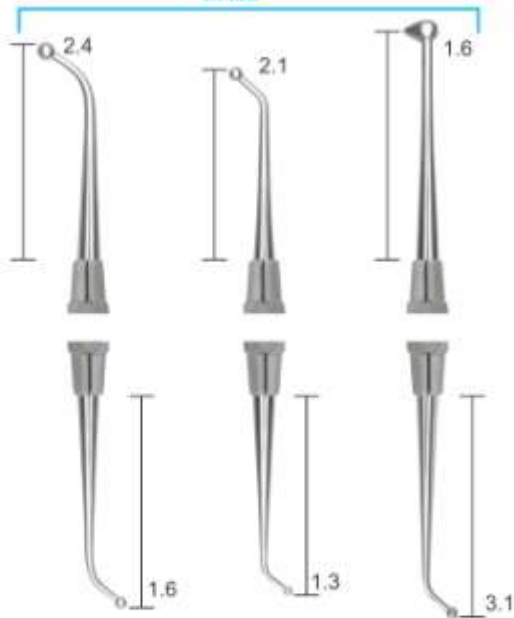

DE-655
18
#41, #6

DE-656
26/27S
#41, #6

DE-657
27/29
#41, #6, #7, #8

BEAVERTAIL



DE-658
2

DE-659
2
Double-End

ACORN



DE-660
21
#41, #6

DE-661
21B
#41, #6, #8

LADMORE



DE-662
2
Ladmore

• 2.4

• 2.1

• 1.6

• 2.6

• 2.6

• 2.7

• 3.0

• 1.9

• 1.6

• 1.3

• 3.1

• 1.5

• 1.7

• 2.7

• 1.3

DE-648
1T
Tanner



- Инструменты для реставрации
- Instruments pour plombage
- Füllungsinstrumente (mit Kontrawinkel)

- Инструменти для реставрації
- Instrumentos para obturaciones
- مرءة التصوك

RESTORATIVE INSTRUMENTS SOLID HANDLE 6MM, LENGTH 170MM

BURNISHERS

PERIODONTAL FILES

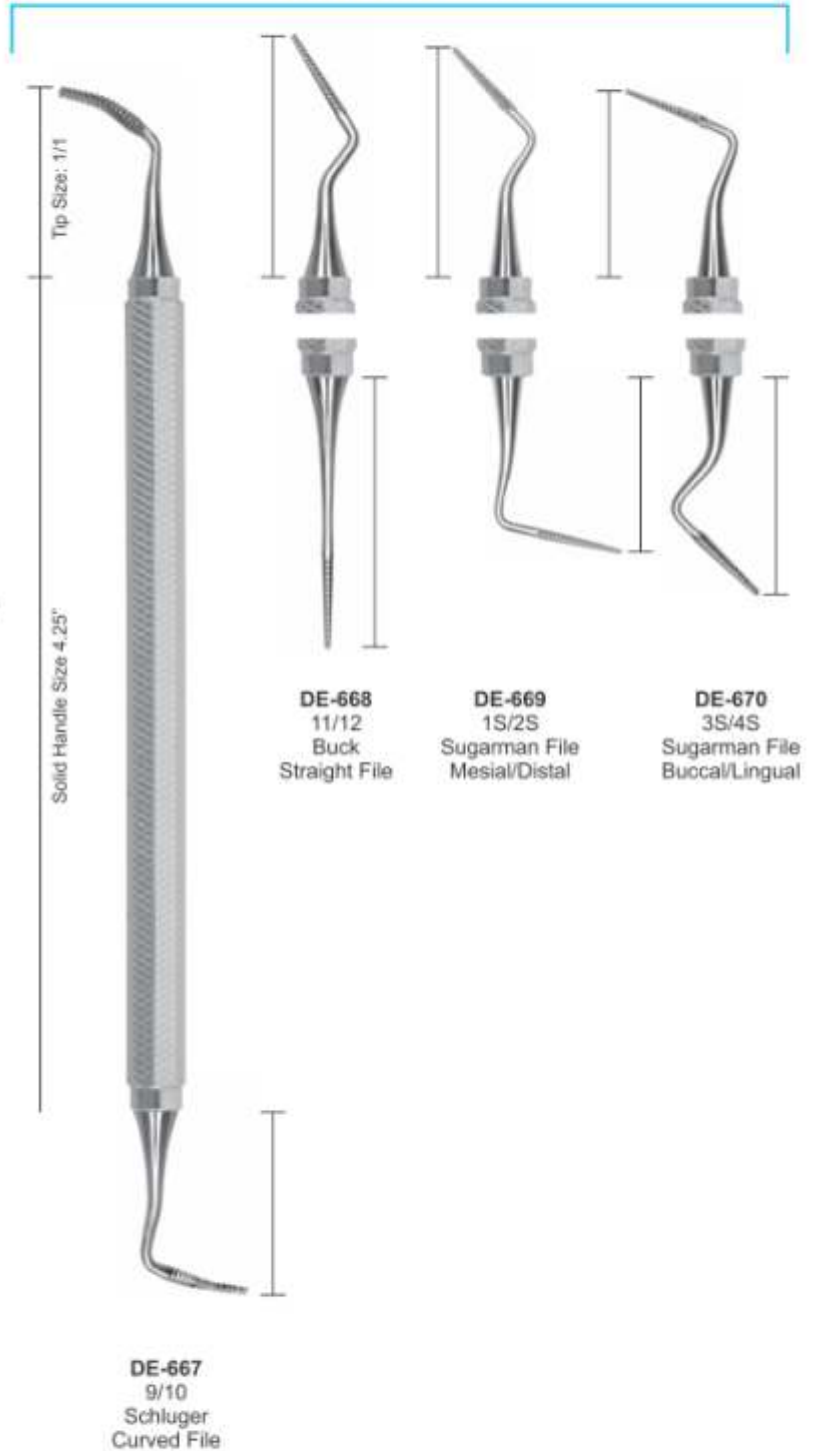
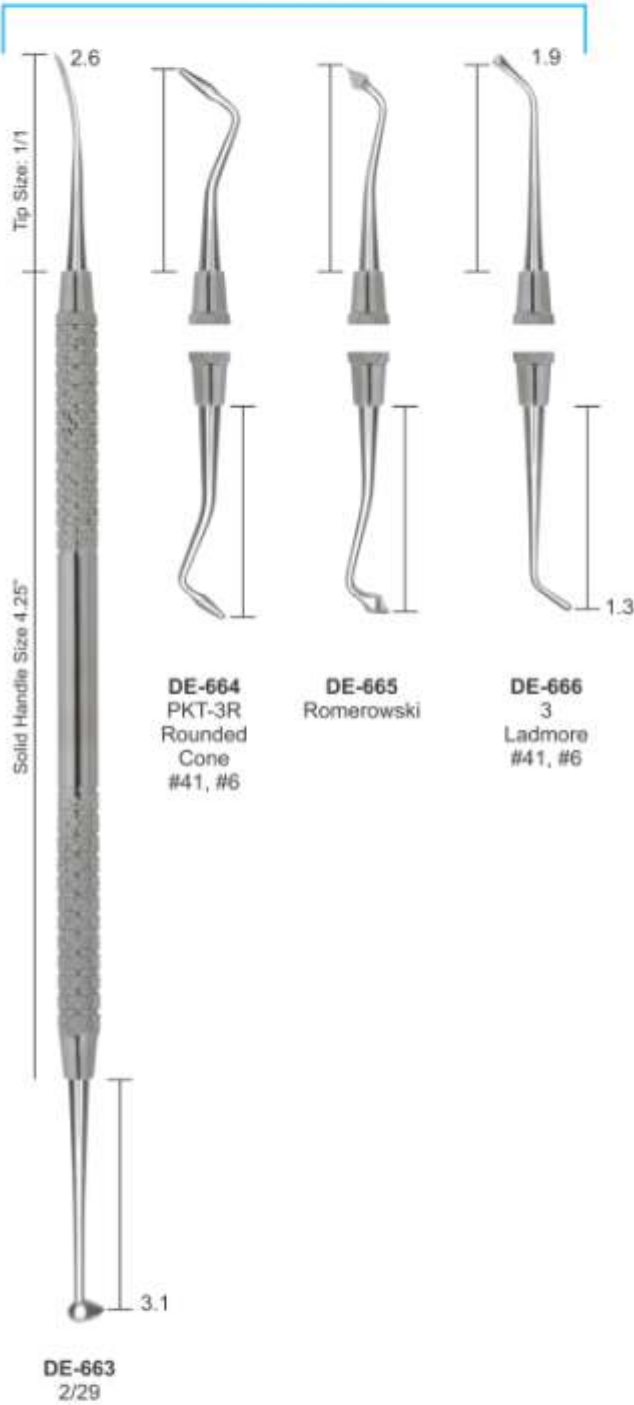
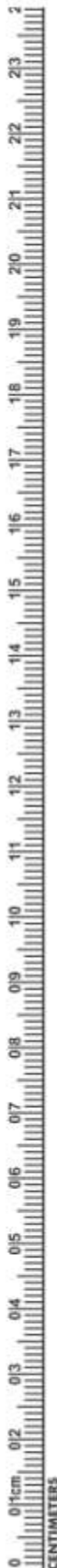

FILLING INSTRUMENTS

- Инструменты для реставрации
- Instruments pour plombage
- Füllungsinstrumente (mit Kontrawinkel)
- Инструменти для реставрації
- Instrumentos para obturaciones
- ملء الصكوك

COMPOSITE/PLASTIC FILLING INSTRUMENTS SOLID HANDLE 6MM, LENGTH 170MM

BURNISHER FILLING INSTRUMENTS

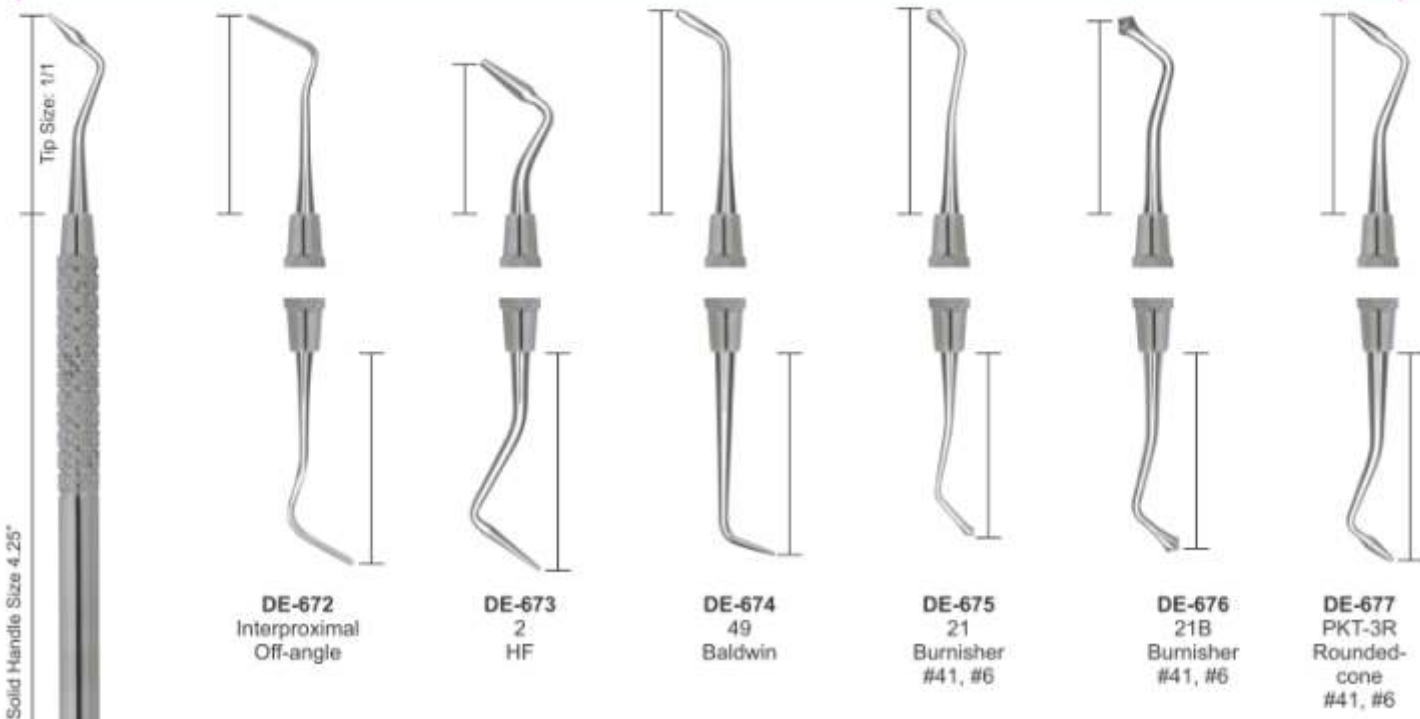

UNIVERSAL FILLING INSTRUMENTS

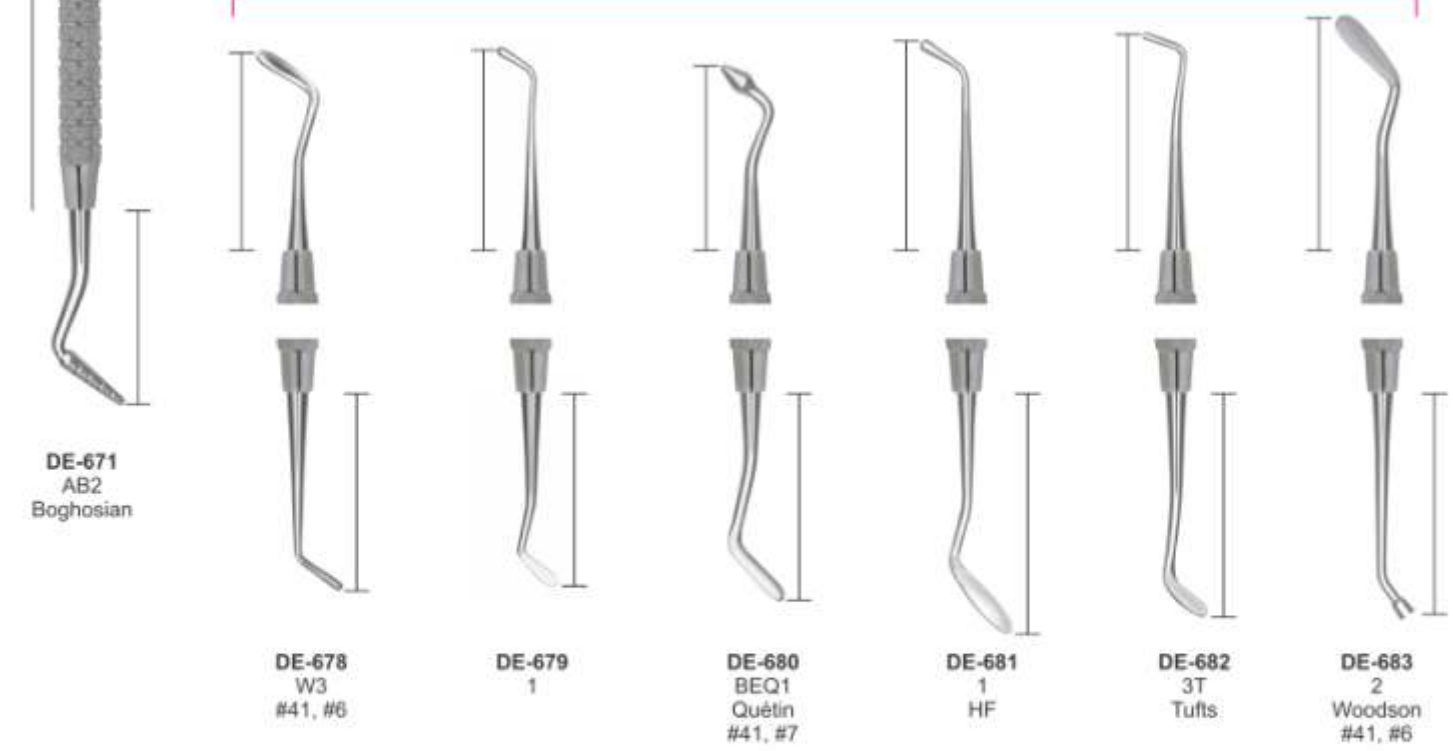

- Инструменты для реставрации
- Instruments pour plombage
- Füllungsinstrumente (mit Kontrawinkel)

- Инструменти для реставрації
- Instrumentos para obturaciones
- ملء الصكوك

FILLING INSTRUMENTS SOLID HANDLE 6MM, LENGTH 170MM



AMALGAM CARVERS

- Инструменты для реставрации
- Instruments pour amalgame
- Amalgampistolen
- Инструменти для реставрації
- Instrumentos para amalgama
- تقطيع المنعم

AMALGAM INSTRUMENTS SOLID HANDLE 6MM, LENGTH 170MM



- Инструменты для реставрации
- Instruments pour amalgame
- Amalgampistolen
- Инструменты для реставрації
- Instrumentos para amalgama
- تقطیع المنعم

AMALGAM INSTRUMENTS SOLID HANDLE 6MM, LENGTH 170MM

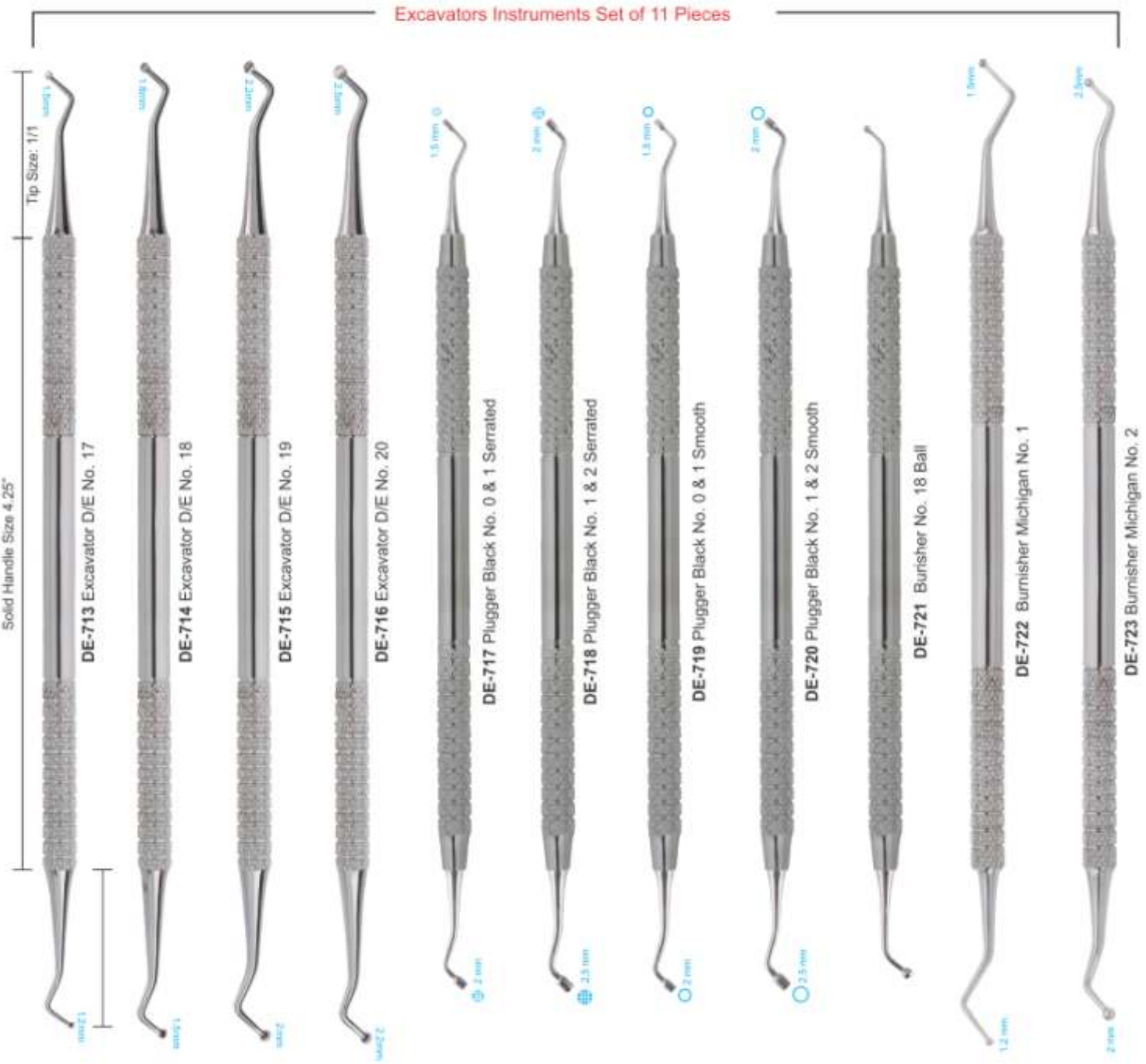

PERIODONTAL INSTRUMENTS

- Инструменты пародонтологические
- Instruments pour la parodontologie
- Instrumente für die Parodontologie
- Інструменти пародонтологічні
- Instrumentos para periodoncia
- الصنوك اللثة

SICKLE SCALERS INSTRUMENTS SOLID HANDLE 6MM, LENGTH 170MM

SICKLE SCALERS

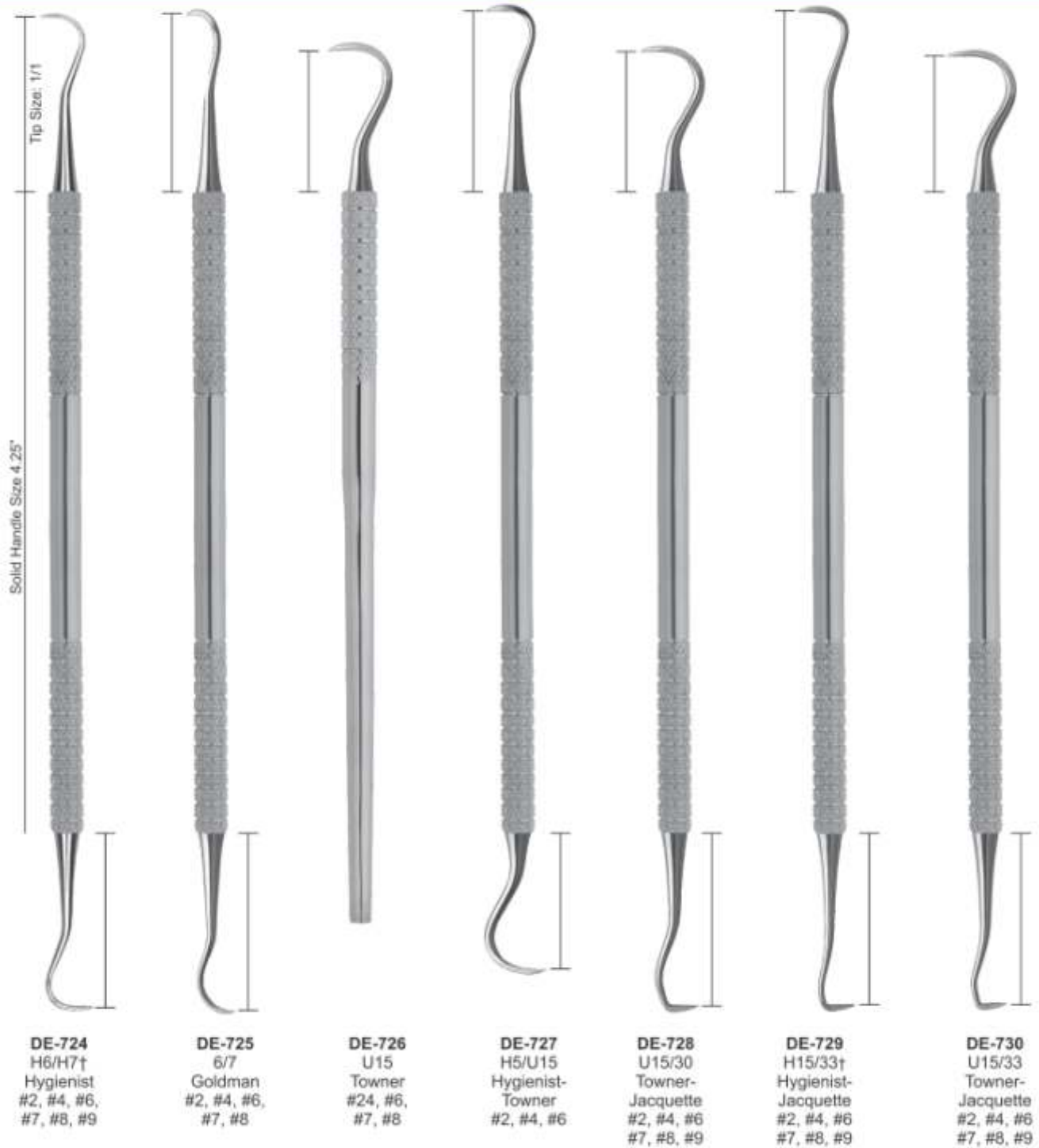

- Инструменты пародонтологические
- Instruments pour la parodontologie
- Instrumente für die Parodontologie

- Інструменти пародонтологічні
- Instrumentos para periodoncia
- الصكوك اللثة

PERIODONTAL INSTRUMENTS SOLID HANDLE 6MM, LENGTH 170MM

JACQUETTE SCALERS

CRANE-KAPLAN

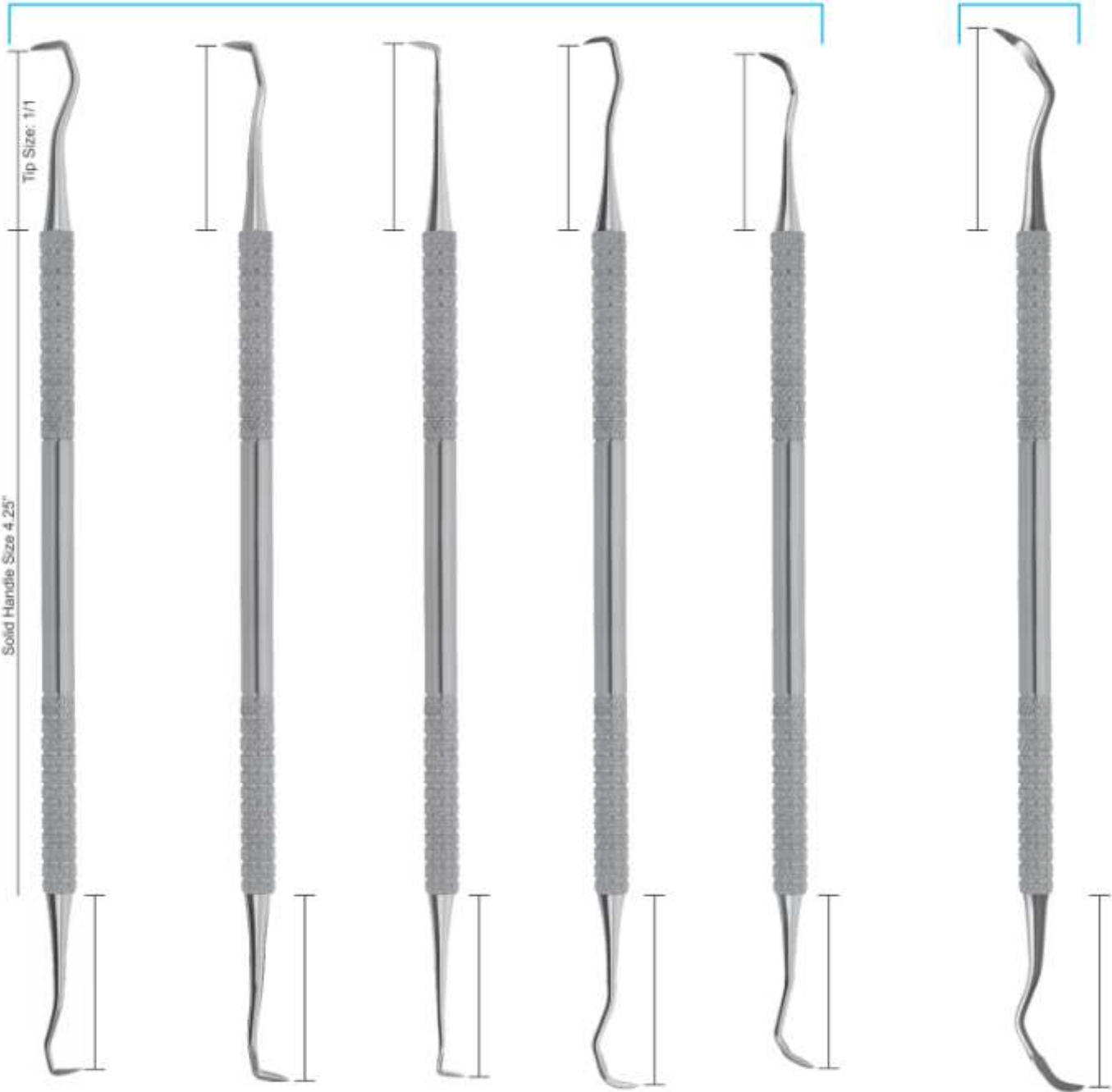

DE-731
30/33
Hygienist
Jacquette
#2, #4, #6,
#7, #8, #9

DE-732
31/32
Jacquette
#2, #4, #6,
#7, #8, #9

DE-733
34/35
Jacquette
#2, #4, #6,
#7, #8, #9

DE-734
H3/H4
Jacquette
#2, #4, #6,

DE-735
14/15
Posterior
Jacquette
#2, #4, #6,

DE-736
CK-6
#2, #4, #6,

PERIODONTAL INSTRUMENTS

- Инструменты пародонтологические
 - Instruments pour la parodontologie
 - Instrumente für die Parodontologie
- Инструменти пародонтологічні
 - Instrumentos para periodoncia
 - الصوك اللثة

PERIODONTAL INSTRUMENTS SOLID HANDLE 6MM, LENGTH 170MM SCALER/CURETTE SETS



- Кюрети
- Curetas
- Küretten
- Кюрети
- Curette
- کرتس

SCALER/CURETTE SETS

GOLDMAN-FOX SET



- | | | | | | | | | | |
|------------------------------------|---|--|---|---|--|--|--|---|---|
| DE-744
103/106
#4, #6 | DE-744A
104/105
Hoe/Chisel
#4, #6 | DE-745
107/108
#2, #4, #6
#7, #8 | DE-746
107/108S
Modied
#2, #4 | DE-747
1/2
(shown)
#2, #4, #6
#7, #8, #9 | DE-749
3/4†
(shown)
#2, #4, #6
#7, #8, #9 | DE-751
5/6†
(shown)
#2, #4, #6
#7, #8, #9 | DE-754
7/8†
(shown)
#2, #4, #6
#7, #8, #9 | | |
| | | | | DE-748
1/2
Rigid
#2, #4, #6
#7, #8, #9 | DE-750
3/4
Rigid
#2, #4, #6
#7, #8, #9 | DE-752
5/6
Rigid
#2, #4, #6
#7, #8, #9 | DE-753
5/6
Extra Rigid
#4, #6 #7,
#8 | DE-755
7/8
Rigid
#2, #4, #6
#7, #8, #9 | DE-756
7/8
Extra Rigid
#2, #4, #6
#7, #8, #9 |

**SCALER/CURETTE SETS INSTRUMENTS
SOLID HANDLE 6MM, LENGTH 170MM**

CURETTES

- Кюретт
- Curetas
- Küretten
- Кюретт
- Curette
- كرتس

GRACEY CURETTE INSTRUMENTS SOLID HANDLE 6MM, LENGTH 170MM
GRACEY CURETTES



DE-757
9/10†
(shown)
#2, #4, #6
#7, #8, #9

DE-759
11/12†
(shown)
#2, #4, #6
#7, #8, #9

DE-792
13/14†
(shown)
#2, #4, #6
#7, #8, #9

DE-765
15/16†
(shown)
#2, #4, #6
#7, #8, #9

DE-767
17/18
#2, #4, #6
#7, #8, #9

DE-758
9/10
Rigid
#2, #4, #6
#7, #8

DE-760 11/12 Rigid #2, #4, #6 #7, #8, #9	DE-761 11/12 Extra Rigid #4, #6 #7, #8
---	---

DE-793 13/14 Rigid #2, #4, #6 #7, #8, #9	DE-764 13/14 Extra Rigid #4, #6 #7, #8
---	---

DE-766
15/16
Rigid
#2, #4, #6
#7, #8, #9

DE-768
17/18
Rigid
#2, #4, #6
#7, #8, #9



- Кюрети
 - Curetas
 - Küretten
- Кюрети
 - Curette
 - كرتيس



**CURETTE INSTRUMENTS
HOLLOW HANDLE 8.5MM, LENGTH 170MM**



DE-769 Hemingway
2mm, 2mm

DE-770 Hemingway
3mm, 3mm

DE-771 Hemingway
4mm, 4mm

**CURETTE INSTRUMENTS
SOLID HANDLE 6MM, LENGTH 170MM**



DE-772 Hemingway
2mm, 2mm

DE-773 Hemingway
3mm, 3mm

DE-774 Hemingway
4mm, 4mm

**CURETTE INSTRUMENTS
SOLID HANDLE 6MM, LENGTH 170MM**



DE-775 Hemingway
2mm, 2mm

DE-776 Hemingway
3mm, 3mm

DE-777 Hemingway
4mm, 4mm

EXCAVATORS

- Экскаваторы
- Excavateurs
- Excavatoren
- عسكافوتوري
- Excavadores

EXCAVATORS INSTRUMENTS SOLID HANDLE 6MM, LENGTH 170MM SPOONS

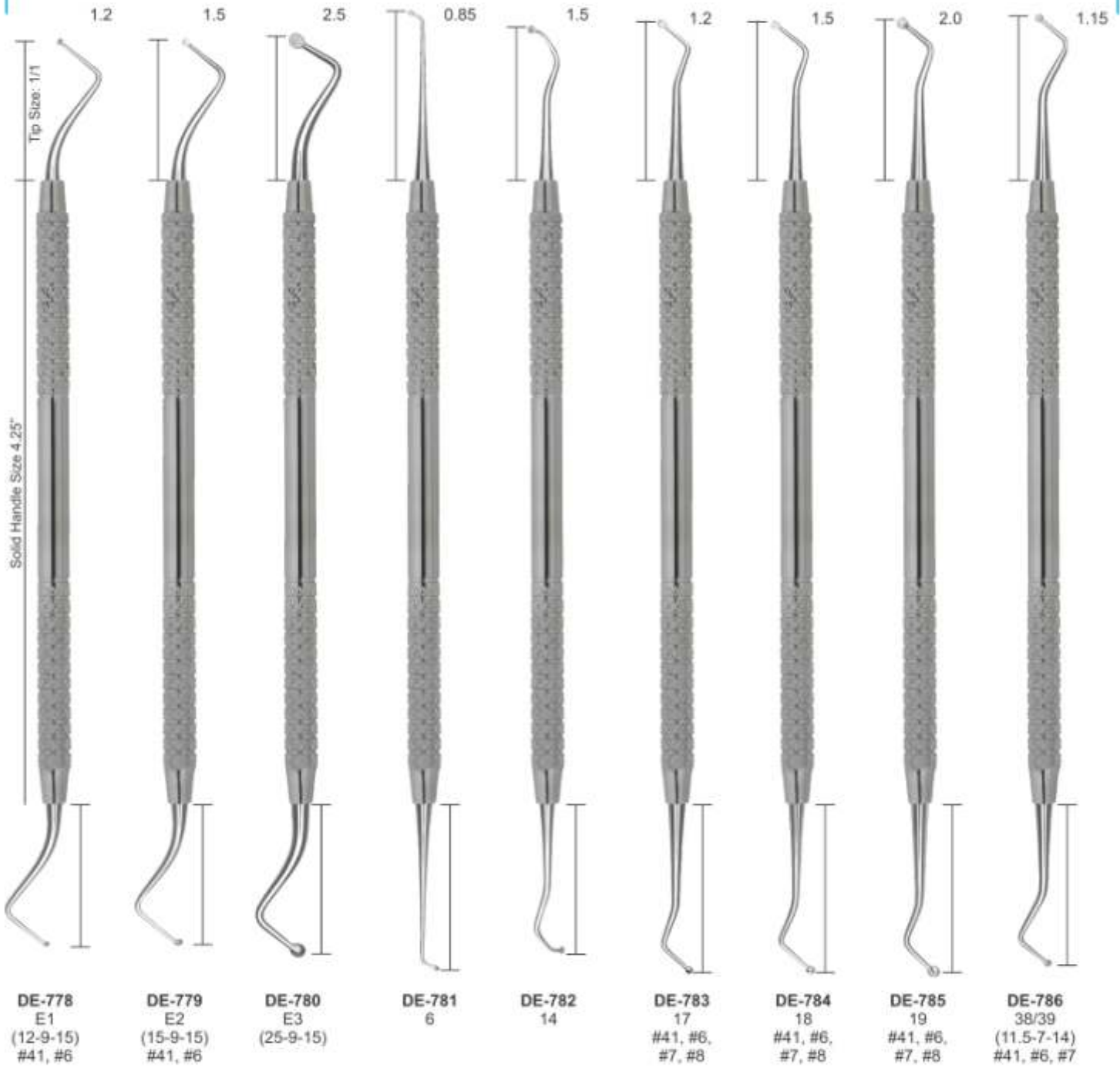

- Экскаваторы
- Excavateurs
- Excavatoren
- Экскаватори
- Excavadores
- حفارات



**EXCAVATORS INSTRUMENTS
SOLID HANDLE 6MM, LENGTH 170MM**

Model	Tip Size	Instrument Type
DE-787 17W	1.2	Oval Spoons/Darby-Perry
DE-788 18W	1.5	Oval Spoons/Darby-Perry
DE-789 19W	1.8	Oval Spoons/Darby-Perry
DE-790 220/221 Darby-Perry #41, #6	1.5	Oval Spoons/Darby-Perry
DE-791 2 Glick	1.5	Excavators
DE-792 31L #41, #6	1.0	Excavators
DE-793 31W Oval Spoon	1.3	Excavators
DE-794 32L #41, #6	1.5	Excavators
DE-795 33L #41, #6	2.0	Excavators

Note: Solid Handle Size 4.25" is indicated for all instruments.

EXCAVATORS

- Эскаваторы
- Excavateurs
- Excavatoren
- عسكافوتوري
- Excavadores
- حفارات

EXCAVATORS INSTRUMENTS SOLID HANDLE 6MM, LENGTH 170MM

BLADES



- Экскаваторы
- Excavateurs
- Excavatoren
- Экскаватори
- Excavadores
- حفارات

EXCAVATORS INSTRUMENTS SOLID HANDLE 6MM, LENGTH 170MM

ENGLISH PATTERNS

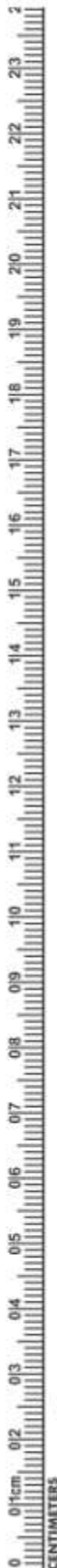

DE-802 Goldstein Interproximal Excavator	DE-803 243	DE-804 244	DE-805 245	DE-806 246	DE-807 125/126 #41, #6	DE-808 127/128 #41, #6	DE-809 129/130 #41, #6	DE-810 131/132 #41, #6	DE-811 153/154
--	----------------------	----------------------	----------------------	----------------------	-------------------------------------	-------------------------------------	-------------------------------------	-------------------------------------	--------------------------

FILLING INSTRUMENTS

- Инструменты для реставрации
- Instruments pour plombage
- Füllungsinstrumente (mit Kontrawinkel)
- Инструменти для реставрації
- Instrumentos para obturaciones
- ملء الصكوك

HATCHETS

RESTORATIVE INSTRUMENTS SOLID HANDLE 6MM, LENGTH 170MM

Tip Size: 1/1

Solid Handle Size 4.25"

DE-813
13/14
(20-9-14)

DE-814
15/16
(15-8-14)

DE-815
17/18
(10-6-14)
#41, #6

DE-816
51/52
(15-8-12)

DE-817
53/54
(10-6-12)
#41, #6

DE-812
8/9H
(10-7-14)
#41, #6

DE-818
8A
#41, #6

DE-819
11
#41, #6

DE-820
179

DE-821
G

DE-822
1/2
Trico

DE-823
DPT6
Darby Perry
Trimmer

DE-824
W1

DE-825
1
Woodson
#41, #6

ANTERIOR

INCHES

- Инструменты для реставрации
- Instruments pour plombage
- Füllungsinstrumente (mit Kontrawinkel)

- Инструменти для реставрації
- Instrumentos para obturaciones
- مرآة التصوگ

CARVERS

RESTORATIVE INSTRUMENTS SOLID HANDLE 6MM, LENGTH 170MM



DE-827
Inter-proximal
Off-Angle

DE-828
1/2-3
Hollenback
#41, #6,
#7, #8

DE-829
3S
Hollenback
#41, #6, #7

DE-830
3
Hollenback

DE-831
8
Wiland
Minn.IPC1
#41, #6, #7

TANNER

WALL

WARD

DE-826
Inter-proximal
#41, #6, #7

DE-832
3
Tanner

DE-833
4
Tanner

DE-834
5
Tanner

DE-835
6
Tanner

DE-836
1
Wall

DE-837
3
Wall

DE-838
1
Ward

DE-839
2
Ward

AMALGAM CARVERS

- Инструменты для реставрации
- Instruments pour amalgame
- Amalgampistolen
- Инструменти для реставрації
- Instrumentos para amalgama
- تقطيع المنقر

RESTORATIVE INSTRUMENTS

ANDREW SOLID HANDLE 6MM, LENGTH 170MM CLAPPISON/FRAHAM

HOLLENBACK

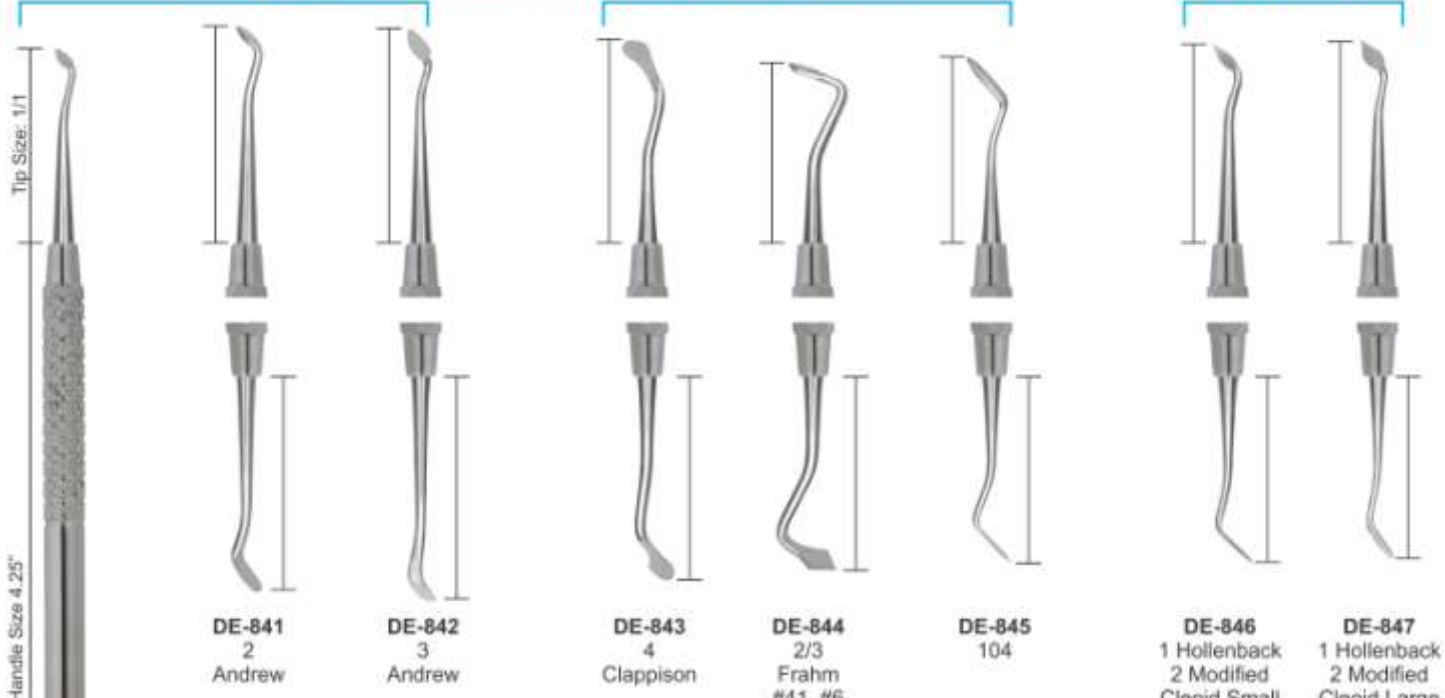

HOLLENBACK

THARP

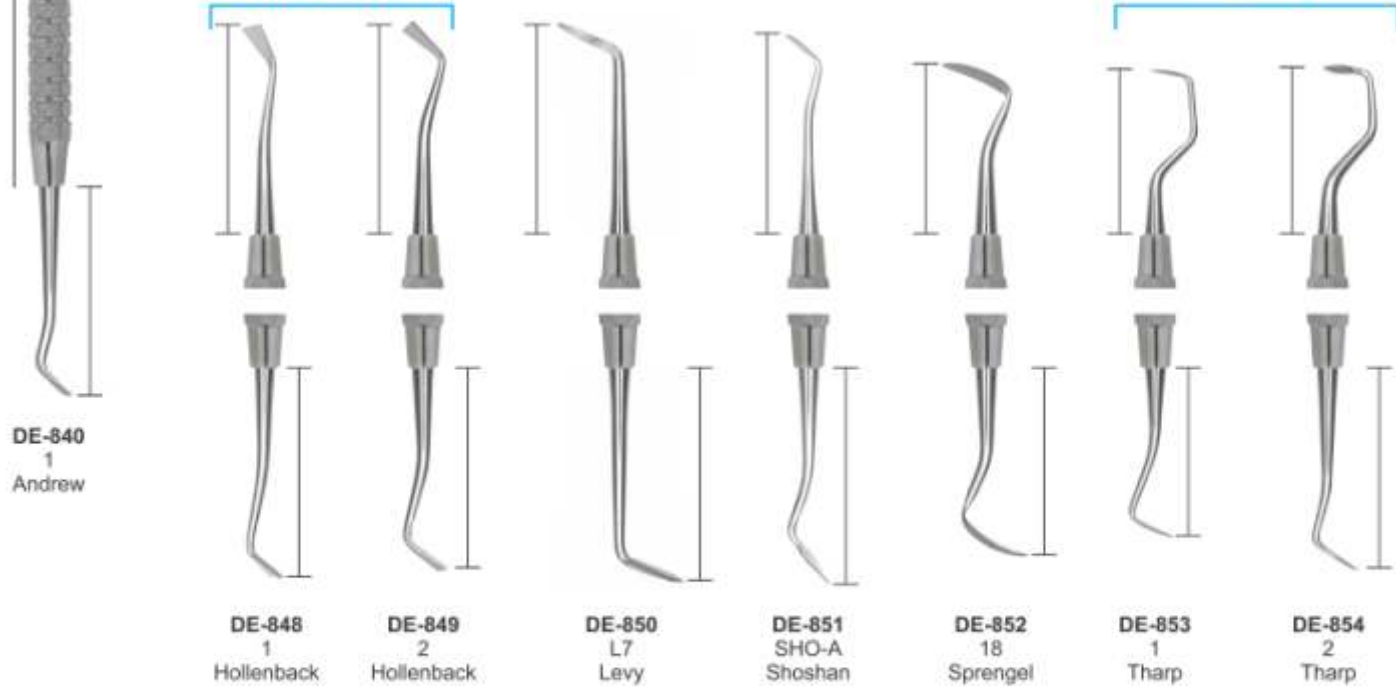

- Инструменты для реставрации
- Instruments pour amalgame
- Amalgampistolen
- Инструменты для реставрації
- Instrumentos para amalgama
- تقطیع المنعم

RESTORATIVE INSTRUMENTS SOLID HANDLE 6MM, LENGTH 170MM

CARVERS

AMALGAM FILES

HOES

Forming Line Angles on Anterior Preparations.

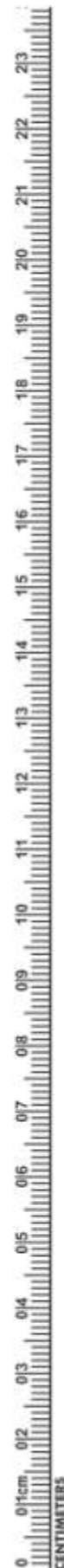

DE-856
Discoid-Cleoid Carver
Tip Size: 1/1

DE-857
31/32 Rhein

DE-858
1/4 Wedelstaedt

DE-859
2/5 Wedelstaedt

DE-860
1/2

DE-861
4/5 #41, #6, #7

DE-862
3/6 #41, #6, #7

DE-863
20 (14-6-8)

DE-864
21 (10-4-8)

DE-865
22 (10-4-14)

DE-866
23 (6.5-2.5-9)

DE-867
89/92 #41, #6, #7

DE-868
90B

DE-869
W-A-C-D

Solid Handle Size 4108mm

Solid Handle Size 122mm

FILLING INSTRUMENTS

- Инструменты для реставрации
- Instruments pour plombage
- Füllungsinstrumente (mit Kontrawinkel)
- Инструменти для реставрації
- Instrumentos para obturaciones
- ملء الصكوك

RESTORATIVE INSTRUMENTS
SOLID HANDLE 6MM, LENGTH 170MM

MARGIN TRIMMERS



DE-870
26
(13-95-8-14)
Distal



DE-871
27
(13-80-8-14)
Mesial



DE-872
28
(10-95-7-14)
Distal
#41, #6



DE-873
29
(10-80-7-14)
Mesial
#41, #6



DE-874
77/78
(15-95-8-12)
Distal



DE-875
79/80
(15-80-8-12)
Mesial

ANGLE FORMERS



DE-876
30/31
(12-80-5-8)



DE-877
32/33
(9-80-4-8)



DE-878
34/35
(7-80-2.5-9)



- Инструменты для реставрации
 - Instruments a modeler
 - Modellierinstrumente
- Инструменти для реставрації
 - Instrumentos para modelar
 - أدوات تقطيع

P.K. THOMS WAXING INSTRUMENTS SOLID HANDLE 6MM, LENGTH 170MM

P.K. THOMAS WAXING INSTRUMENTS

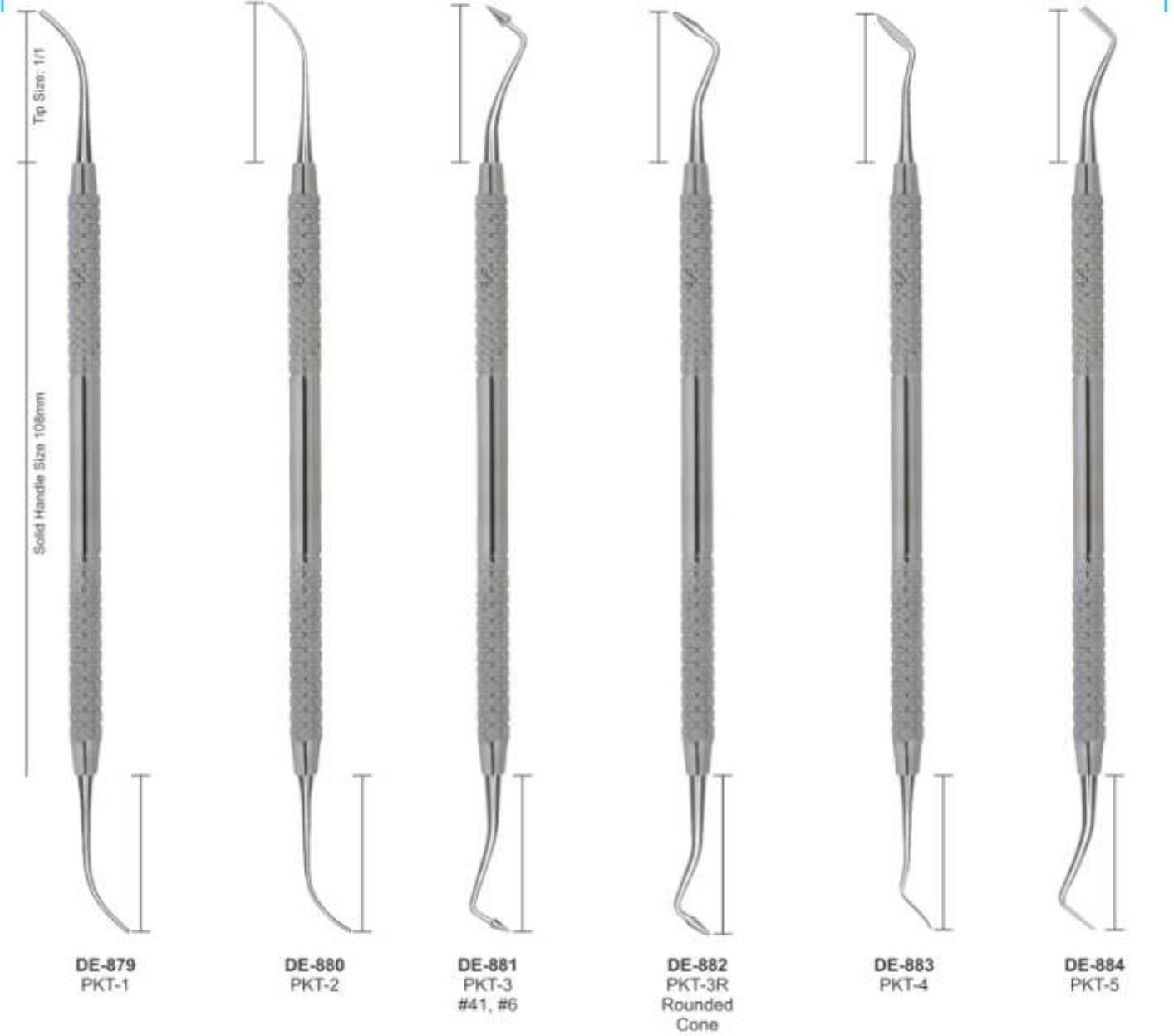

DE1-884
P.k. Thomas Waxing
Instruments
Kit



- Инструменты для реставрации
 - Instruments a modeler
 - Modellierinstrumente
- Инструменти для реставрації
 - Instrumentos para modelar
 - أدوات تقطيع

P.K. THOMS WAXING INSTRUMENTS SOLID HANDLE 6MM, LENGTH 170MM

P.K. THOMAS WAXING INSTRUMENTS



DE-879
PKT-1

DE-880
PKT-2

DE-881
PKT-3
#41, #6

DE-882
PKT-3R
Rounded
Cone

DE-883
PKT-4

DE-884
PKT-5

DE1-884
P.k. Thomas Waxing
Instruments
Kit



FILLING INSTRUMENTS

- Инструменты для реставрации
- Instruments pour plombage
- Füllungsinstrumente (mit Kontrawinkel)
- Инструменти для реставрації
- Instrumentos para obturaciones
- ملء الصكوك

CHISELS

HOES



- Шпатели для цемента
- Spatules à ciment
- Zementspatel

- Шпателі для цементу
- Espátulas para cemento
- ملاعق الاسمنت

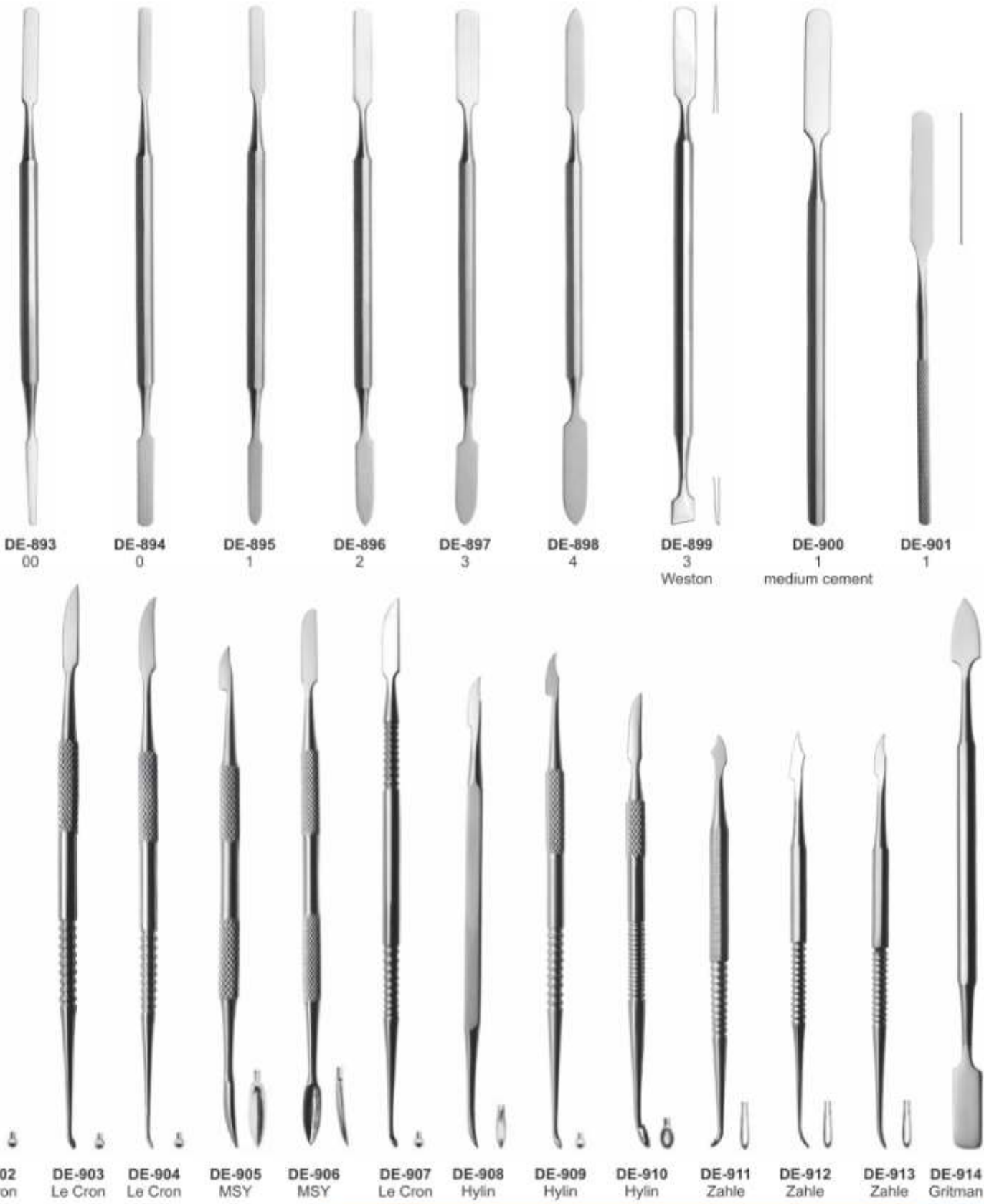
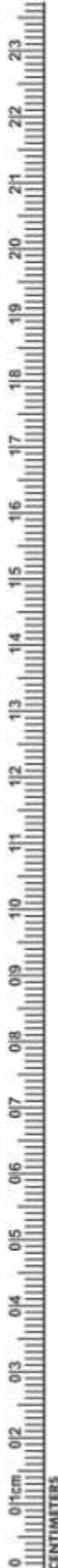

WAX KNIVES

- Ножи для воска
- Couteaux à cire
- Wachsmesser
- Ножи для воску
- Cuchillos para cera
- المسككين الشمع

ALGINATE, PLASTER SPATULAS, WAX KNIVES PLASTER FOR KNIVES & PLASTER SHEAR



DE-915
Wooden Handle
Fig. 5
21.5 cm



DE-916
Wooden Handle
Fig. 7
19.5 cm curved



DE-917
Wooden Handle
Fig. 8
20 cm curved



DE-918
Wooden Handle
Fig. 9
22.5 cm curved



DE-919
Hook Knives



DE-920
Fig. 1
Lessmann
12.5 cm



DE-921
Fig. 2
Lessmann
17 cm



DE-922
Fig. 1
with small spoon
12.5 cm



DE-923
Fig. 2
with large spoon
17 cm



DE-924
Bacolite Handle
Wax Knives,
Small



DE-925
Bacolite Handle
Wax Knives,
Large



DE-926
Wooden Handle
Wax Knives,
Small



DE-927
Wooden Handle
Wax Knives,
Large



DE-928
Plaster Knife



DE-929
Fig. 1
17 cm



DE-930
Fig. 3
16 cm



DE-931
Fig. 4
16 cm



DE-932
Special Inox
19.5 cm



- Артикуляторы
- Artocilar
- Artikulations

- Артикулятори
- Articulere
- ارتیکولاتورس



DE-933

Technical Datas:

Intercondylar distance	120 mm.
condylar inclination	fixed at 30°
Bennet angle	fixed at 7°
Incisal table inclination	10°
Distance between mounting plates	85 mm.
Weight	400 gr.
Opening (item 5000)	125°
Opening (Item 5010)	180°



DE-934

Technical Datas:

Intercondylar distance	110 mm.
condylar inclination	fixed at 30°
Bennet angle	fixed at 7°
Incisal table inclination	flat
Distance between mounting plates	85 mm.
Weight	450 gr.
Opening	180°



DE-935

Stainless Steel Finishing
DE-936
Royal Blue



DE-937



DE-938



DE-939



DE-940



DE-941



DE-942



DE-943



DE-944



DE-945



DE-946
Nakawalni
Dental Laboratory
Instrument

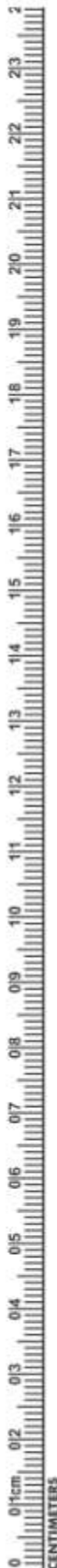

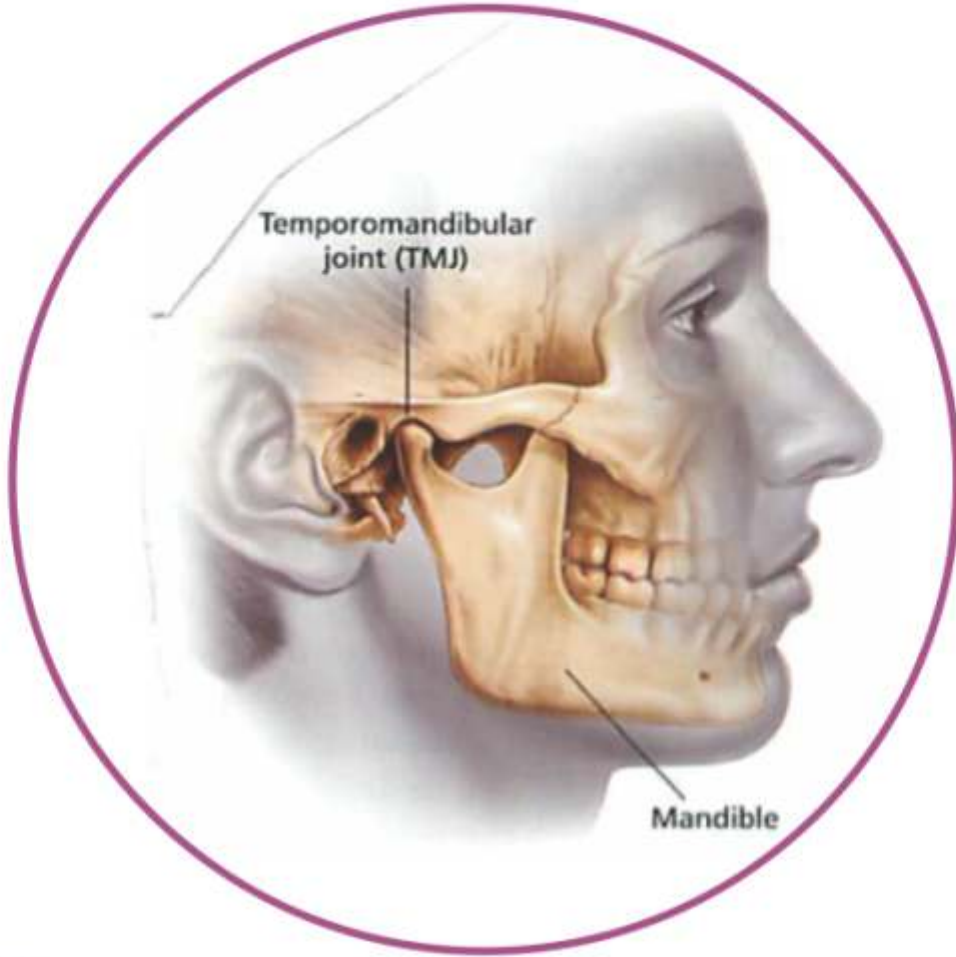

- Роторасширители
- Ecarteurs - Ouvre-bouches
- Vestibulumabhalter / Mundspanner
- Роторозширювачі
- Separadores - Abre-bocas
- الكاشحات - الكمامات الفم



DE-947
Mouth Gag Molt
11 cm for (Children)



DE-948
Mouth Gag Molt
14 cm for (Adults)



Cheek Retractor
DE-949 140 mm
DE-950 180 mm



Cheek Retractor
DE-951 140 mm



DE-952
Wangen Holder,
vestibule
15 cm, with or without
lip protection,



DE-953
Wangen Holder,
vestibule 15 cm, with
or without lip protection,



DE-954
Wangen Holder
Wangen holder with dual
function, 17 cm,



DE-955
140 mm

DE-956
150 mm

Cheek Retractor

RETRACTORS - MOUTH GAGS

- Роторасширители
- Ecarteurs - Ouvre-bouches
- Vestibulumabhalter / Mundspanner
- Роторозширювачі
- Separadores - Abre-bocas
- الكاشطات، الكمامات، الفم



DE-957
Fig. 1
weitlaner
10.5cm
13.5cm



DE-958
Fig. 2
weitlaner
10.5cm
13.5cm



DE-959
Stainless Steel
Double
Ended Cheek
Retractors



DE-960
Stainless Steel
Single
Ended Cheek
Retractors



Weitlander
DE-961 11cm
DE-962 13cm
DE-963 15cm



DE-967
Denhard
12 cm



DE-968
Roser-König
16 cm



DE-969
Roser-König
19 cm



Jennings
DE-964 11cm
DE-965 13cm
DE-966 15cm



Wound, Bendable
Retractor, individually or as saving kit!

- Ранорасширители
- Ecarteurs
- Wundhaken

- Ранорозширювачі
- Separadores
- انبساطات

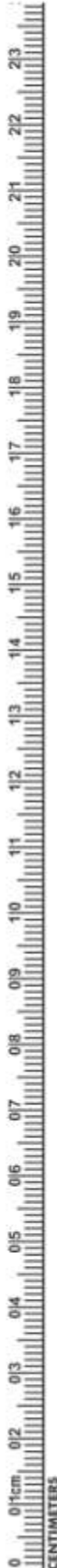

DE-970
Cheek Retractor
Long



DE-971
Cheek Retractor
Long



DE-972
Cheek Retractor
Long



Retractor with Ergo Grip DE-973 24 cm, ergonomic handle,



DE-974
Cheek Retractors,
Retractor Ivory
Width adjustable & fixable, 20 cm,



Cheek Retractors, tongue depressors DE-975 19 cm



Cheek Retractors, Minnesota DE-976 16 cm



Cheek Retractors, DE-977 20 cm easy to bend by hand,



Cheek Retractors, retractor and tongue pushers BISHOP DE-978 16 cm,



Retractors Cheek retractor combination DE-979 25 cm,

RETRACTORS

- Ранорасширители
- Ecarteurs
- Wundhaken
- Ранорозширювачі
- Separadores
- الكاشحات



DE-982
Retractors, Unique
Length 175 mm,
angled 45°



DE-983
Retractors, Unique
Length 175 mm,
angled 90°



DE-984
Retractors
16cm



DE-985
Retractors
19cm



DE-986
Retractors, Mini-Langenbeck
16 cm, hooks 22 mm,



DE-987
Retractors, Cheek
retractors combination
21 cm, 2



DE-988
Mini Retractor
about 8 cm,



DE-989
Retractors
17 cm, hooks 22 mm



- Ранорасширители
 - Ecarteurs
 - Wundhaken
- Ранорозширювачі
 - Separadores
 - انشعاب



30 x 16 mm

DE-990
Retractors, surgical-flat
surgically-flat, 21 cm, hook
30x16 mm.



DE-991
Retractors, surgical-flat
surgically-flat, 21 cm, hook
42x11 mm



60 x 12 mm

DE-992
Retractors, surgical-flat
surgically-flat, 21 cm, hook
63x12 mm.



Retractors, surgical-flat
surgically-flat, 21 cm, hook
DE-993 30x16 mm,
DE-994 42x11 mm,
DE-995 63x12 mm,



Retractors, Langenbeck
21 cm, hook
DE-996 30x11 mm
DE-997 30x16 mm.



DE-998
Retractors
21 cm.



DE-999
Farabeuf
(120 X 12mm
Set of 2 pices)



DE-1000
Retractor Seldin



DE-1001
FELDMAN
RETRACTOR
5-1/2", 14cm

GUM SCISSORS

- Ножницы десневые
- Ciseaux a gencives
- Zahnfleischscheren
- Ножиці для ясен
- Tijeras para encias
- مقص صمغ



DE-1002
Iris
115mm
Straight



DE-1003
Iris
115mm
Curved



DE-1004
Goldman-Fox
130mm
Saw edge, straight



DE-1005
Goldman-Fox
130mm
Saw edge, Curved



DE-1006
La Grange
115mm
Saw edge, double Curved



Mayo
DE-1007 140mm
DE-1008 170mm
DE-1009 230mm
Straight



Mayo
DE-1010 140mm
DE-1011 170mm
DE-1012 230mm
Curved



Metzenbaum
DE-1013 145mm
DE-1014 180mm
DE-1015 200mm
Straight



Metzenbaum
DE-1016 145mm
DE-1017 180mm
DE-1018 200mm
Curved



DE-1019
Kelly
160mm
Straight



DE-1020
Kelly
160mm
Curved



DE-1021
Iris
115mm
Straight



DE-1022
Iris
115mm
Curved



DE-1023
La Grange
115mm
Double Curved



DE-1024
Goldman-Fox
130mm, Straight



DE-1025
Goldman-Fox
130mm, Curved



DE-1026
Kelly
160mm, Curved



DE-1027
Iris
115mm, Straight



DE-1028
Iris
115mm, Curved



DE-1029
Micro Iris
90mm, Curved



- Ножницы десневые
- Ciseaux a gencives
- Zahnfleischscheren
- Ножци для ясен
- Tijeras para encias
- مقص صمغ



DE-1030
Iris
115mm
Angled



DE-1031
Iris
115mm
Curved



DE-1032
Goldman-Fox
130mm
Saw edge,
straight



DE-1033
Goldman-Fox
130mm
Saw edge,
curved



DE-1034
Goldman-Fox
130mm
Saw edge,
double curved



DE-1035
La Grange
115mm
Saw edge,
double curved



DE-1036
Neumann
120mm
Saw edge,
double curved



DE-1037
Kilner (Ragnell)
120mm
Straight



DE-1038
Kilner (Ragnell)
120mm
Curved



DE-1039
Joseph
140mm
Straight



DE-1040
Joseph
140mm
Curved



DE-1041
Kelly
160mm
Straight



DE-1042
Kelly
160mm
Curved



DE-1043
Locklin
160mm
Saw edge,
angular



DE-1044
Locklin
160mm
Saw edge,
angular



DE-1045
Dean
170mm
Saw edge,
angular



DE-1046
Spencer
90mm



DE-1047
Spencer
130mm



DE-1048
Spencer
115mm



DE-1049
Noyes
110mm, Straight



DE-1050
Noyes
110mm
Curved



DE-1051
Noyes
110mm
Angular



DE-1052
Castroviejo
150mm
Curved

NEEDLE HOLDERS

- Иглодержатели
- Porte-aiguilles
- Nadelhalter
- Голкотримачи
- Porta-agujas
- اصحاب ابرة



DE-1053
130mm
Straight



DE-1054 Mayo
130mm 130mm
DE-1055 Mayo
160mm 160mm
DE-1056 Mayo
180mm 180mm
Straight Curved



DE-1057 Mayo
140mm 140mm
DE-1058 Mayo
200mm 200mm
Straight Curved



DE-1059 Metzenbaum
145mm 145mm
DE-1060 Metzenbaum
200mm 200mm
Straight Curved



DE-1061
Beebee
110mm
Saw edge,
straight



DE-1062
Beebee
110mm
Saw edge,
curved



DE-1063
Beebee
110mm
Saw edge, straight



DE-1064
Beebee
110mm
Saw edge, curved



DE-1065
Universal
120mm
Saw edge



DE-1066
Universal
120mm



Crile
DE-1067 130mm
DE-1068 150mm
DE-1069 180mm



DE-1070
Halsey
130mm



DE-1071
Baumgartner
130mm



DE-1072
Derf
120mm



DE-1073
Delicate
150mm



Mayo-Hegar
DE-1074 130mm
DE-1075 160mm
DE-1076 180mm
DE-1077 200mm



DE-1078
Crile-Wood
150mm
straight



DE-1079
Crile-Wood
150mm
curved



- Иглодержатели
- Porte-aiguilles
- Nadelhalter

- Голкотримачи
- Porta-agujas
- اصحاب ابرة



Castroviejo
DE-1080 130mm
DE-1081 150mm
DE-1082 180mm



DE-1083
 Halsey
 130mm



DE-1084
 Baumgartner
 130mm



DE-1085
 Derf
 120mm



DE-1086
 Delicate
 150mm



DE-1087
 Adson
 170mm



Mayo-Hegar
DE-1088 130mm
DE-1089 160mm
DE-1090 180mm
DE-1091 200mm



DE-1092
 Crile-Wood
 150mm



Castroviejo
DE-1093 str 140mm cvd
DE-1094 str 180mm cvd



Olsen-Hegar Needle
 Holder With Scissors
DE-1095 140mm



Gillies Needle
 Holder With Scissors
DE-1096 160mm



Mathieu
DE-1097 140mm
DE-1098 170mm



Castroviejo
DE-1099 str 140mm cvd
DE-1100 str 180mm cvd



Olsen-Hegar Needle
 Holder With Scissors
DE-1101 140mm



Gillies Needle
 Holder With Scissors
DE-1102 160mm



Hartmann (Baby
 Mosquito)
DE-1103 90mm straight



Halstead Mosquito
DE-1105 125mm
 Straight

DE-1106
 Curved

DE-1104
 125mm
 Curved

HAEMOSTATIC FORCEPS & TOWEL CLAMPS

- Зажимы артериальные, зажимы для салфеток
- Pincas hemostatiques, Pincas a compreses
- Arterienklemmen, Tuschklammen
- Затискачі артеріальні, затискачі для серветок
- Pinzas hemostaticas, Pinzas para compresas
- المنقط هيموستاتيك المشابك متلفحة

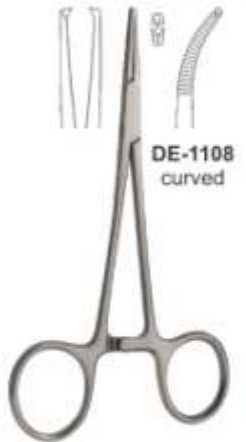

Hairstead Mosquito 1x2
DE-1107 125mm
straight



Kelly
DE-1109 140mm
straight



Rochester-Pean
DE-1111 140mm
DE-1112 160mm
DE-1113 180mm
DE-1114 200mm
straight



Rochester-Kocher 1x2
DE-1119 140mm
DE-1120 160mm
DE-1121 180mm
DE-1122 200mm
straight



DE-1127
Kelly-Rankin
160mm
straight



Lorna
DE-1129 100mm
DE-1130 130mm



DE-1131
Allis-Baby 3:4
150mm



DE-1132
Allis 4:5
200mm



DE-1133
Allis 6:7
200mm



Backhaus
DE-1134 140mm
Not-perforating and
not-damaging



DE-1135
Backhaus
130mm



DE-1136
Backhaus
85mm



DE-1137
Jones
90mm



Gross Maier
Dressing Forceps
DE-1138 200mm straight



Foerster
Dressing Forceps
DE-1140 200mm



Young
Tongue Forceps
DE-1141 170mm



Collins
Tongue Forceps
DE-1142 170mm



- Инструменты для системы коффердам
- Pincas porte-crampons a digue
- Kofferdam Klammerzangen
- Инструменты для системи коффердам
- Pinzas de engrapar para dique de caucho
- البند المطاط الملقط المشابهة

DE-1143

On request the Content of the rubber dam kit can be changed with other instruments.

Content:

- 01 Anisworth
- 02 Brewer
- 03 Clamps Stand
- 04 Denture Plate
- 05 Rubber Dam Frame
- 06 Rubber Dam Box Lower Case
- 07 Rubber Dam Box Upper Case
- 08 Rubber Dam Clamp Fig. 212
- 09 Rubber Dam Clamp Fig. 211
- 10 Rubber Dam Clamp Fig. 8
- 11 Rubber Dam Clamp Fig. 8A
- 12 Rubber Dam Clamp Fig. 14
- 13 Rubber Dam Clamp Fig. 14A
- 14 Rubber Dam Clamp Fig. 0
- 15 Rubber Dam Clamp Fig. 00
- 16 Rubber Dam Clamp Fig. 2
- 17 Rubber Dam Clamp Fig. 2A
- 18 Rubber Dam Clamp Fig. 7

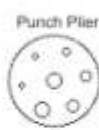
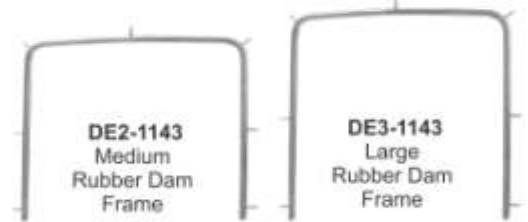
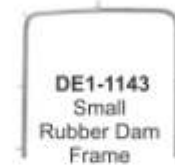

10 01cm 012 013 014 015 016 017 018 019 020 021 022 023 2

CENTIMETERS

RUBBER DAM CLAMPS

- Кляммера для коффердама
- Clampons pour digue
- Kofferdam Klammern
- Кляммера для коффердама
- Grapas para dique de caucho
- المشابك السد المطاط



DE-1149
Fig. 15



DE-1150
Fig. 18



DE-1151
Fig. 24



DE-1152
Fig. 25



DE-1153
Fig. 26



DE-1154
Fig. 28



DE-1155
Fig. 30



DE-1156
Fig. 31



DE-1157
Fig. 51



DE-1158
Fig. 138



DE-1159
Fig. 139



DE-1160
Fig. 200



DE-1161
Fig. 201



DE-1162
Fig. 202



DE-1163
Fig. 203



DE-1164
Fig. 204



DE-1165
Fig. 205



DE-1166
Fig. 3



DE-1167
Fig. W3



DE-1168
Fig. 4



DE-1169
Fig. 56A



DE-1170
Fig. 7



DE-1171
Fig. 7A



DE-1172
Fig. 8



DE-1173
Fig. 8A



DE-1174
Fig. W8A



DE-1175
Fig. 10



DE-1176
Fig. 11



DE-1177
Fig. 12A



DE-1178
Fig. 13A



DE-1179
Fig. 14



DE-1180
Fig. 14A



DE-1181
Fig. 14AN



DE-1182
Fig. 22



DE-1183
Fig. 27



DE-1184
Fig. 207



DE-1185
Fig. 29



DE-1186
Fig. 206



DE-1187
Fig. 208



DE-1188
Fig. 209



DE-1189
Fig. 1



DE-1190
Fig. 1A



DE-1191
Fig. 2



DE-1192
Fig. 2A



DE-1193
Fig. W2A



DE-1194
Fig. 0



DE-1195
Fig. 00



DE-1196
Fig. 210



DE-1197
Fig. 211



DE-1198
Fig. 212



DE-1199
Fig. 6



DE-1199
Fig. 6



DE-1200
Fig. 9



DE-1200
Fig. 9



DE-1201
Fig. N06



DE-1202
Fig. U67



DE-1203
Fig. 214



DE-1204
Fig. P1



DE-1205
Fig. P2



DE-1206
Fig. G-1



DE-1206
Fig. G-1



DE-1207
Fig. G-2



DE-1207
Fig. G-2



- Инструменты для удаления коронок
- Arrache-couronnes
- Teleskopkronenzangen

- Инструменты для видалення коронок
- Arranca-corona
- مزيلات التاج



DE-1210
Crown Spreaders



DE-1211
Mershon
14 cm
Band Pusher



DE-1212
Fig. 0
Manual Crown Removers
Handle with 3 tips
Only 3 tips



DE2-1212



DE3-1212



DE4-1212



DE6-1212



DE7-1212



DE8-1212

Manual Crown Removers
Handle with 3 tips
Only 3 tips



DE-1213
Manual Crown Remover



DE-1214
Complete with 3 tips
and tightening keys



semi-automatic crown
& bridge remover



DE-1215



DE-1216
Manual Crown Remover

MATRIX RETAINERS

- Матрицедержатели
- Porte Matrices
- Matrizenspanner

- Матрицеутримувачи
- Porta Matrices
- مصالفة الخدم



DE-1217
Fig. 5
Ivory 8
5 cm



DE-1218
Fig. 6
Ivory 8
6 cm



DE-1219
Fig. 7
Ivory 8
7 cm



DE-1220
Fig. 1
Tofflemire-Universal



DE87-1220



DE1-1220



DE2-1220

Siqveland Retainers



DE-1221
Fig. 2
Tofflemire-Junior



DE-1222
Fig. 3
Tofflemire-Senior



DE-1223
Narrow



DE-1224
Wide

Amalgam Well



DE-1225
Stainless Steel
Amalgam Well



DE-1226
Ivory 12



DE-1227
Ivory 1



DE-1228
Ivory



DE-1229
Elliot



Инструменты для амальгамы
 • Instruments pour amalgame
 • Amalgamisinstrumente

• Инструменты для амальгами
 • Instrumentos para amalgama
 • الصكوك المنقر

• Ручки для скальпелей
 • Manches de bistouris
 • Skalpellgriffe

• Ручки для скальпелів
 • Mangos de bisturi
 • مشربط مقبض



Ø 2mm

DE-1230
 Fig. 10
 165mm
 English pattern



Ø 2mm

DE-1231
 Fig. 1
 185mm
 German pattern



Ø 2mm

DE-1232
 Fig. 1
 150mm
 Swiss pattern



Ø 2mm

DE-1233
 Fig. 1
 150mm



Ø 2mm

DE-1234
 Fig. 2
 150mm, 45°



Ø 2mm

DE-1235
 Fig. 3
 140mm, 90°



DE-1236
 Fig.3
 5" (12.7cm)



DE-1237
 Fig.3G
 5" (12.7cm)



DE-1238
 Fig.4
 5 1/2" (13.7cm)



DE-1239
 6 Way Adjustable Angled Scalpel Handle



Locks At 90°, 60°, 30°,
 Straight, 120°, 150°, 180°,
 Angles

AMALGAM INSTRUMENTS

- Инструменты для амальгамы
- Instruments pour amalgame
- Amalgam Instrumente
- Инструменти для амальгами
- Instrumentos para amalgama
- الصكوك الملقح

AMALGAM CARRIERS

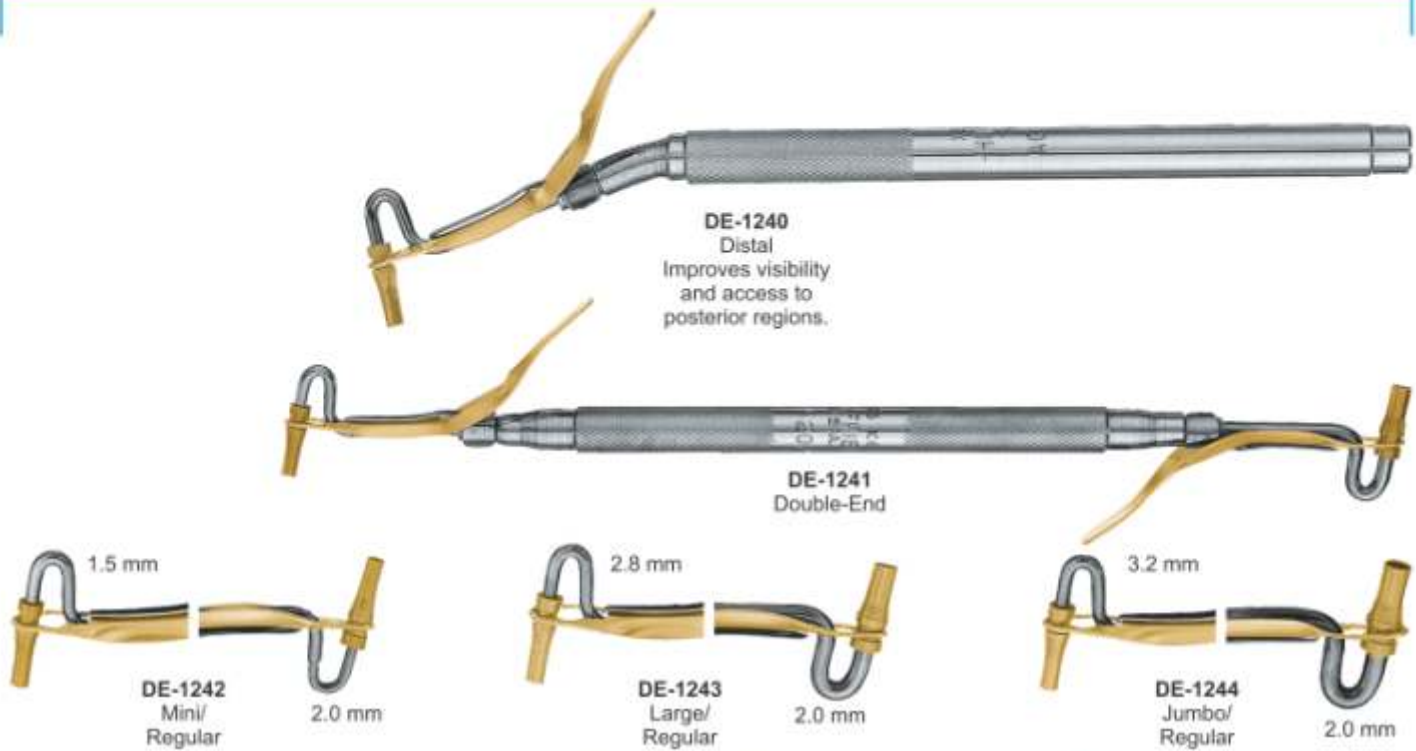

TIP SIZES FOR DOUBLE-END



ROOT PLANNING FILES



DE-1252
Kramer-Nevins
Bone Chisel



DE-1253
Kramer-Nevins
Bone Chisel



DE-1254
Molt 18.5cm
Auto Clavable
Plastic Tips.



DE-1255
Mead 18.5cm
Non Auto Clavable
Plastic Tips.



DE-1256
Miller



DE-1257
Miller

BONE FILES



DE-1258
Miller 21



DE-1259
Miller 1X
cross cut



DE-1260
Miller 2X
cross cut



DE-1261
Miller 52



DE-1262
Wahl 1



PERIODONTAL INSTRUMENTS

- Инструменты пародонтологические
- Instruments pour la parodontologie
- Instrumente für die Parodontologie
- Инструменти пародонтологічні
- Instrumentos para periodoncia
- الصكوك اللثة

PERIOSTEEL ELEVATORS





Behind Every Smile is a Story

- QUALITY - ЯКІСТЬ
- PRECISION - ТОЧНІСТЬ
- ACCURACY - ПРАВИЛЬНІСТЬ
- DURABILITY - ЗНОСОСТІЙКІСТЬ

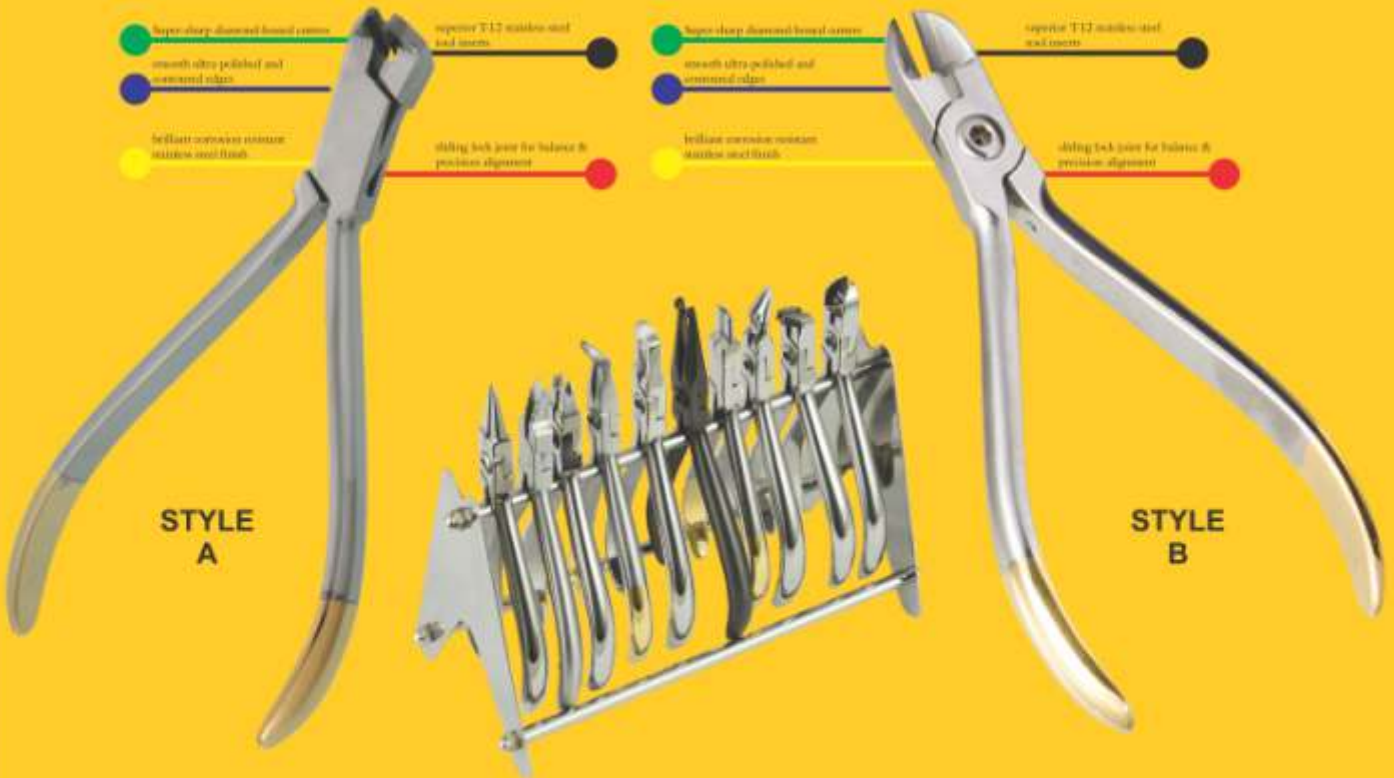
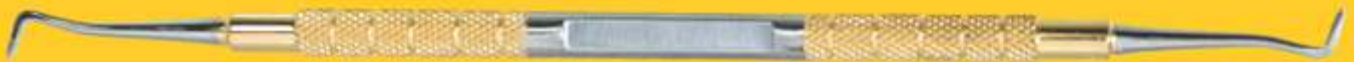

ORTHODONTIC INSTRUMENTS

- Инструменты ортодонтические
- Instrumentos Ortodonticos
- Orthodontische Instrumente
- Инструменти ортодонтични
- Instruments Orthodontiques
- أدوات تقويم الأسنان



DE-1277 Aluminum Height Gauge 0.22
DE-1278 Aluminum Height Gauge 0.18
DE1-1278 Height Gauge Movable



DE-1279 Bone Bracket Gauge



DE1-1279 Endo Finger Ruler Span Measure Scale



DE2-1279 Endo Finger Ruler Span Measure Scale

DE3-1279 Endo Finger Ruler Span Measure Scale



DE4-1279 Compass De Willis



DE-1280 Bone Thickness Gauge 40mm, 180mm



DE-1281 Osteometer Measuring Forceps



DE-1282 Bracket Placer Tweezers (Extra Fine Tip)



DE-1283 Direct Bonding Bracket Holders 135mm



DE-1284 Direct Bonding Bracket Holders 136mm



DE-1285 Direct Bonding Bracket Holders 135mm



DE-1286 Deluxe Bracket Holder



DE-1287 Deluxe Bracket Holder Tweezers



DE-1288 Deluxe Bracket Holder Tweezers



DE1-1288 Bracket Tweezers Slot Aligner



DE2-1288 Direct Bonding Bracket Holders 140mm



DE3-1288 Bracket Placing Tweezers



DE4-1288 Easy Access Tweezers



DE5-1288 Direct Bonding Bracket Holders 140mm



DE6-1288 Direct Bond Bracket Holder Tweezers Small Tip



DE7-1288 Exact Bracket Holder Tweezers



DE8-1288 Easy Ecess Tweezers



DE9-1288 Slipper Tweezers



- Инструменты ортодонтические
- Instrumentos Ortodonticos
- Orthodontische Instrumente
- Инструменти ортодонтични
- Instruments Orthodontiques
- أدوات تقويم الأسنان



DE-1289
Band seater auto cleavable



DE-1290
Ortho light scaler double ended



DE-1291
Ortho light scaler double ended



DE-1292
Ortho light scaler double ended



DE-1293
Twiel-on elastic module instrument



DE-1294
Twiel-on elastic module instrument



DE-1295
Schure Band Seater



DE-1296
Ortho light scaler

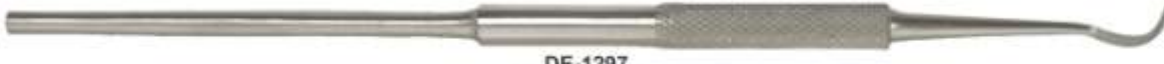

DE-1297
Ortho light scaler



DE-1298
Ortho light scaler heavy

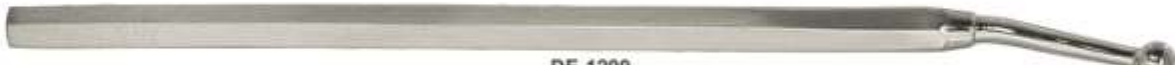

DE-1299
Ortho instrument



DE-1300
Ortho instrument



DE-1301
Ortho Light Band Pusher Scaler

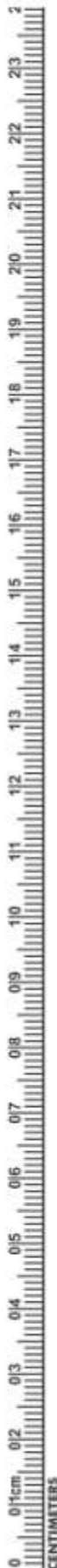

ORTHODONTIC INSTRUMENTS

- Инструменты ортодонтические
- Instrumentos Ortodonticos
- Orthodontische Instrumente
- Инструменти ортодонтични
- Instruments Orthodontiques
- أدوات تقويم الأسنان



DE-1302
Ortho Light double ended
ligature director



DE-1303
Ortho Light double ended
ligature director scaler



DE-1304
Ortho Light double ended ligature scaler director tivate coil spring
are remove modules with one instruments



DE-1305
Ortho band pusher scaler



DE-1306
Ortho Light Band Pusher Scaler



DE-1307
Ortho ligature director single ended



DE-1308
Ortho Light double ended ligature
director scaler



DE-1309
Ortho Light double ended ligature scaler/director
tivate coil spring are remove modules with one instruments



DE-1310
Ortho Light double ended ligature director



DE-1311
Ortholite Ligature Director Scaler



DE-1312
Ortho light ligature director double ended



DE-1313
Double ended cement spatula



DE-1314
Ortho light scaler single ended



- Щипцы для ортодонтии и протезирования
- Pincers pour l'orthodontie et la prothèse
- Zangen für Kieferorthopädie und Prothetik

- Щипці для ортодонції та протезування
- Alicates para ortodoncia y prótesis
- كمانة لتقويم الأسنان بروتيزيس

BOX JOINT PLIERS



DE-1315
Universal Dolphin Style
Wire Bending & cutting pliers



DE-1316 Band Removing Plier
The curved blade of the band removing plier can strip easily and gently remove directly to the tooth. Length 130mm



DE-1317
Tweed Loop forming Pliers



DE-1318
How Plier curved
Universally usable tool for the multiband technology for wires up to .028". Length 130mm



DE-1319 How Plier
Universally usable tool for the multiband technology for wires up to .028". Length 135mm



DE-1320
Nance Loop forming Pliers



DE-1321
Bracket Removing Plier curved
Bracket Removing Plier curved for easy removal of brackets in the posterior region. Length 130mm



DE-1322
Young Wire Bending & Loop Forming Pliers



DE-1323
Wire Bending & Loop Forming Pliers



DE-1324
Adams, small wire bending and loop forming Pliers



DE-1325
Bracket Removing Plier Round Box
Bracket removing plier for comfortable and quick removal of the brackets. Length 135mm



DE-1326
Weingart Plier medium
Weingart plier that are ideal due to their curved tip for setting sheets and is capable of bending the ends. Length 145mm



PLIERS FOR ORTHODONTICS & PROSTHETICS

- Щипцы для ортодонтии и протезирования
- Pincas pour l'orthodontie et la prothèse
- Zangen für Kieferorthopädie und Prothetik
- Щипці для ортодонції та протезування
- Alicates para ortodoncia y prótesis
- كمانة لتقويم الأسنان بروتستیس

BOX JOINT PLIERS

DE-1327 Adams Plier Round Box

Adams pliers for bending wire arches and bends right angles for wires up to .022", .025 tip to beak. Length 125mm



DE-1328 Falcon Beak Contouring Pliers.



DE-1329 wires up to 0.020" / 0.7mm.



DE-1330 Johnson Contouring Pliers



DE-1331 Aderer Large wire bending and loop forming pliers



DE-1332 Tweed / angle rectangular arch forming & Torquing pliers



DE-1333 Adams Plier Adams pliers for bending wire arches and bends right angles for wires up to .022", .025 tip to beak. Length 125mm

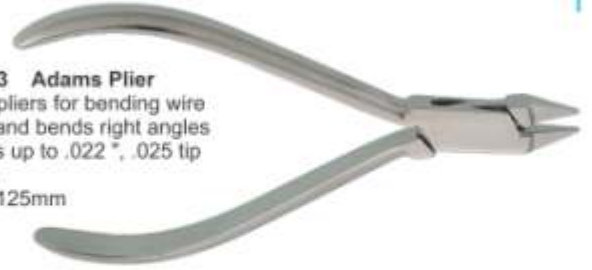

DE-1334 Tweed Loop Formin Pliers



DE-1335 Bird Beak Plier Standard Bird Beak Wire bending plier without notches, which is suitable as a universal utility tool. Length 125mm



DE-1336 Mini Ligature cutters



DE-1337 Small Fluch-cut distal and cutting Pliers with safety hold fitted with un-breakable, corrosion resistant and durable stainless steel tips



DE-1338 Large Fluch-cut distal and cutting Pliers with safety hold fitted with un-breakable, corrosion resistant and durable stainless steel tips



- Щипцы для ортодонтии и протезирования
- Pincers pour l'orthodontie et la prothèse
- Zangen für Kieferorthopädie und Prothetik

- Щипці для ортодонції та протезування
- Alicates para ortodoncia y prótesis
- كمانة لتقويم الأسنان بروستھتیس

BOX JOINT PLIERS



DE-1339
Tweed / Angel
1.78mm (.070") wide tips arch forming and torquing pliers



DE-1340
Tweed / Angel
1.78mm (.070") wide tips arch forming and torquing pliers



DE-1341
Lingual / Palatal arch
forming pliers



DE-1342
Aderer
Facebow loop forming Pliers



DE-1343
Waldsavhs wire bending and cutting pliers



DE-1344 Aderer Plier
For the manufacturing of appliances and activation of wires for wires up to .030" .fine tip and up to .036" mean tip. Length 130mm



DE-1345
Contouring Plier



DE-1346
Bands & Crowns Plier
in order to skirt



DE-1347
Ligature Forming Pliers



DE-1348
for double back and triple back bands in 0.30" / 0.76mm & 0.36" / 0.91mm lingual arch wires



DE-1349
Bird Beak Wire Bending & cutting pliers



DE-1350
Weingart Plier medium
Weingart plier that are ideal due to their curved tip for setting sheets and is capable of bending the ends. Length 145mm



PLIERS FOR ORTHODONTICS & PROSTHETICS

- Щипцы для ортодонтии и протезирования
- Pincas pour l'orthodontie et la prothèse
- Zangen für Kieferorthopädie und Prothetik
- Щипці для ортодонції та протезування
- Alicates para ortodoncia y prótesis
- كمانشة لتقويم الأسنان بروستھتیس

L-KEY JOINT PLIERS



DE-1351
Distal end cutter with safety hold, mini head, long handles.
fitted with un-breakable, corrosion resistant and durable stainless steel tips

- 0.30 mm to 0.50 mm (.012" to .020")
- Max. 0.46 mm x 0.64 mm (.018" x .025")
- ⊗ 0.38 mm to 0.53 mm (.0155" to .0215")
- ⊗ Max. 0.53 mm x 0.64 mm (.021" x .025")



DE-1352
Flush-cut distal end cutter with safety hold fitted with un-breakable, corrosion resistant and durable stainless steel tips

- 0.30 mm to 0.50 mm (.012" to .020")
- Max. 0.46 mm x 0.64 mm (.018" to .025")



DE-1353
Soft wire and ligature cutter, Mini fitted with un-breakable, corrosion resistant and durable stainless steel tips

- ⊗ .25 mm to .38 mm (.010" to .015")



DE-1354
Soft wire and ligature cutter, standard fitted with un-breakable, corrosion resistant and durable stainless steel tips

- ⊗ .25 mm to .38 mm (.010" to .015")



DE-1355
Soft wire and ligature cutter, 15° angled fitted with un-breakable, corrosion resistant and durable stainless steel tips

- ⊗ .25 mm to .38 mm (.010" to .015")



DE-1356
Soft wire and ligature cutter, 45° angled fitted with un-breakable, corrosion resistant and durable stainless steel tips

- ⊗ .25 mm to .38 mm (.010" to .015")



DE-1357
Hard wire cutter, straight Fitted with un-breakable, corrosion resistant and durable stainless steel tips

- 0.30 mm to 0.50 mm (.012" to .020")
- Max. 0.56 mm x 0.71 mm (.022" x .028")



DE-1358
Hard wire cutter, 15° angled Fitted with un-breakable, corrosion resistant and durable stainless steel tips

- 0.30 mm to 0.50 mm (.012" to .020")
- Max. 0.56 mm x 0.71 mm (.022" x .028")



DE-1359
Hard wire cutter, 15° angled Non-autoclavable

- 0.30 mm to 0.50 mm (.012" to .020")
- Max. 0.56 mm x 0.71 mm (.022" x .028")



- Щипцы для ортодонтии и протезирования
- Pincers pour l'orthodontie et la prothèse
- Zangen für Kieferorthopädie und Prothetik

- Щипці для ортодонції та протезування
- Alicates para ortodoncia y prótesis
- كمانشة لتقويم الأسنان بروستيزيس

L-KEY JOINT PLIERS



DE-1360
Band removing pliers



DE-1361
Bracket removing pliers angled



DE-1362
Bracket removing pliers straight



DE-1363
Bracket removing pliers with plastic tip



DE-1364
Adhesive removing pliers



DE-1365
Weingart-mini
Utility Pliers

- 0.30 mm to 0.50 mm (.012" to .020")
- Max 0.56 mm x 0.71 mm (.022" x .028")

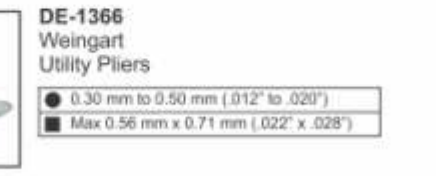

DE-1366
Weingart
Utility Pliers

- 0.30 mm to 0.50 mm (.012" to .020")
- Max 0.56 mm x 0.71 mm (.022" x .028")



DE-1367
How Straight
Utility Pliers

- 0.30 mm to 0.50 mm (.012" to .020")
- Max 0.56 mm x 0.71 mm (.022" x .028")

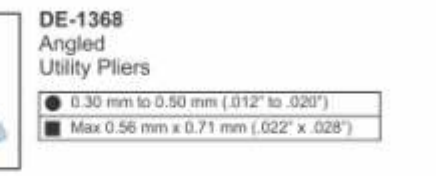

DE-1368
Angled
Utility Pliers

- 0.30 mm to 0.50 mm (.012" to .020")
- Max 0.56 mm x 0.71 mm (.022" x .028")



DE-1369
Wire bending and loop forming pliers
Angled (Bird beak)

- 0.30 mm to 0.50 mm (.012" to .020")
- Max 0.56 mm x 0.71 mm (.022" x .028")

PLIERS FOR ORTHODONTICS & PROSTHETICS

- Щипцы для ортодонтии и протезирования
- Pincers pour l'orthodontie et la prothèse
- Zangen für Kieferorthopädie und Prothetik
- Щипці для ортодонції та протезування
- Alicates para ortodoncia y prótesis
- كمشة لتقويم الأسنان بروستھیس

L-KEY JOINT PLIERS



DE-1370
Multi-purpose pliers, bird beak,
De la rosa and cutter in one

- 0.30 mm to 0.50 mm (.012" to .020")
- Max. 0.46 mm x 0.56 mm (.018" x .022")



DE-1371
Cinch Back / tie back
Distal end bending pliers

- 0.30 mm to 0.50 mm (.012" to .020")
- Max. 0.56 mm x 0.71 mm (.022" x .028")



DE-1372
Hammer head
Distal end bending pliers

- 0.30 mm to 0.50 mm (.012" to .020")
- Max. 0.56 mm x 0.71 mm (.022" x .028")



DE-1373
Nance
Loop forming pliers

- 0.36 mm to 0.71 mm (.014" to .028")
- Max. 0.56 mm x 0.71 mm (.022" x .028")



DE-1374
Detailing step pliers / Bayonet
bending pliers - 1mm

- 0.30 mm to 0.50 mm (.012" to .020")
- Max. 0.56 mm x 0.71 mm (.022" x .028")



DE-1375
Stop pliers V-Bebd - 1mm

- 0.30 mm to 0.50 mm (.012" to .020")
- Max. 0.43 mm x 0.56 mm (.017" x .028")



DE-1376
Lingual / palatal arch forming plies

- 0.76 mm (.030") / 0.91 mm (.036")



DE-1377
Torquing pliers set



DE-1378
Tweed / angel
Rectangular arch forming and
torquing pliers

- 0.30 mm to 0.71 mm (.012" to .028")
- Max. 0.56 mm x 0.71 mm (.022" x .028")



DE-1379
Surgical ball hook crimping pliers,
angled



DE-1380
Surgical ball hook crimping
pliers, straight



PLIERS FOR ORTHODONTICS & PROSTHETICS

- Щипцы для ортодонтии и протезирования
- Pincers pour l'orthodontie et la prothèse
- Zangen für Kieferorthopädie und Prothetik
- Щипці для ортодонції та протезування
- Alicates para ortodoncia y prótesis
- كمشة لتقويم الأسنان بروستھیس

L-KEY JOINT PLIERS



DE-1370
Multi-purpose pliers, bird beak,
De la rosa and cutter in one

● 0.30 mm to 0.50 mm (.012" to .020")
■ Max. 0.46 mm x 0.56 mm (.018" x .022")



DE-1375
Stop pliers V-Bebd - 1mm

● 0.30 mm to 0.50 mm (.012" to .020")
■ Max. 0.43 mm x 0.56 mm (.017" x .028")



DE-1371
Cinch Back / tie back
Distal end bending pliers

● 0.30 mm to 0.50 mm (.012" to .020")
■ Max. 0.56 mm x 0.71 mm (.022" x .028")



DE-1376
Lingual / palatal arch forming plies

● 0.76 mm (.030") / 0.91 mm (.036")



DE-1372
Hammer head
Distal end bending pliers

● 0.30 mm to 0.50 mm (.012" to .020")
■ Max. 0.56 mm x 0.71 mm (.022" x .028")



DE-1377
Torquing pliers set



DE-1373
Nance
Loop forming pliers

● 0.36 mm to 0.71 mm (.014" to .028")
■ Max. 0.56 mm x 0.71 mm (.022" x .028")



DE-1378
Tweed / angel
Rectangular arch forming and
torquing pliers

● 0.30 mm to 0.71 mm (.012" to .028")
■ Max. 0.56 mm x 0.71 mm (.022" x .028")



DE-1374
Detailing step pliers / Bayonet
bending pliers - 1mm

● 0.30 mm to 0.50 mm (.012" to .020")
■ Max. 0.56 mm x 0.71 mm (.022" x .028")



DE-1379
Surgical ball hook crimping pliers,
angled



DE-1380
Surgical ball hook crimping
pliers, straight



- Щипцы для ортодонтии и протезирования
- Pincettes pour l'orthodontie et la prothèse
- Zangen für Kieferorthopädie und Prothetik

- Щипці для ортодонції та протезування
- Alicates para ortodoncia y prótesis
- كمانة لتقويم الأسنان بروستيزيس

L-KEY JOINT PLIERS



DE-1381
Aderer Clamp three jaw wire bending plier for contouring and bending wire up to .30"/.76mm.



DE-1387
Falcon beak contouring plier.

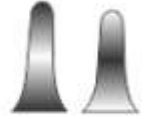

DE-1382
Bird beak plier for bending round, square and rectangle wire up to .30"/.76mm.

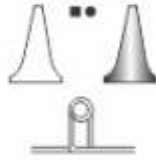

DE-1388
For placement and removal of arch wires, pins and other auxiliaries.



DE-1383
Bird beak plier for light wire bending round, square and rectangular up to .016"/0.41mm.



DE-1389
For placement and removal of arch wires, pins and other auxiliaries in angle design



DE-1384
Double Rounded jaw bending pliers, hooks and wire up to .020"/0.51mm.

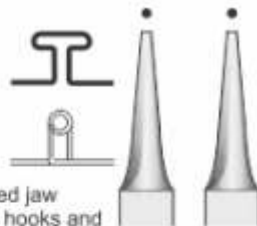

DE-1390
contouring Plier.



DE-1385
Adams pliers for hooks and bending wire up to .030"/0.76mm.



DE-1391
Bending plier. In order to skirt molares bands. With grooved. Recommended wire. 016", 018" and 022" 0.41mm, 0.46mm and 0.56mm



DE-1392
Loop forming in four length 3,4,5 & 6 mm wire capacity 0.22", 56mm.



DE-1386
Johnson pliers for crown band contouring



DE-1393
Arch bending plier design for convenient handling of square or rectangular wire, .020" / 0.51mm.

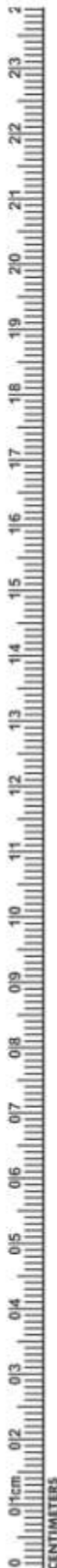

PLIERS FOR ORTHODONTICS & PROSTHETICS

- Щипцы для ортодонтии и протезирования
- Pincas pour l'orthodontie et la prothèse
- Zangen für Kieferorthopädie und Prothetik
- Щипці для ортодонції та протезування
- Alicates para ortodoncia y prótesis
- كمانة لتقويم الأسنان بروستھتیس

LAP & L-KEY JOINT PLIERS



DE-1394
In order to skirt bands and crowns.



DE-1395
Wires up to .020" / 0.7mm.

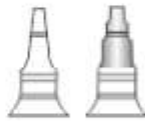

DE-1396
Round and concave plier for loop forming and banding wire up to .020" / .051mm.



DE-1397
Bending for round square or rectangular wire up to 0.30"/0.76mm



DE-1398
for double back and triple back bands in 0.30" / .76mm & 0.36" / .91mm lingual arch wires.



DE-1399
Detailing step plier double-sided offset beak permits bayonet bends. Creates right hand or left hand step-up or stepdown at 1/8, 1/4, or 1mm increments.



DE-1400
"V" bend stop special design makes 1mm "V" bends to shorten archwires or provide a positive stop. Excellent for placing stops in titanium wires. For round or rectangular wires up to .025"



DE-1401
Angle how plier efficient utility plier with serrated beaks for a firm grip. 45 angled tips to access hard to reach areas.



DE-1402
Weingardt plier serrated tips hold wires firmly at a convenient working angle. Tapered beaks fit easily between brackets and hard to reach areas. Our most popular utility plier.



DE-1415
Pin & Ligature Cutters TC.



DE-1416
Mini Pin & Ligature Cutter TC.



DE-1417
Standard Ligature Cutter TC.



DE-1418
V Bend Stop Plier TC.



DE-1419
Angled Direct Bond Bracket Remover TC.



DE1-1419
Cutter Str.



Distal Cutter
14cm
DE2-1419 2.5 mm
DE3-1419 3.0 mm
DE4-1419 3.0 mm



DE5-1419
Arrow Clasp Forming Pliers
12.0cm



DE6-1419
Schwarz
12.5cm





DE-1420
Distal end Cutter, Safety Hold Plier
(Ideal for Cutting Wire) TC.



DE-1421
Hook Crimping Plier Angled
Straight TC.



DE-1422
3 Prong Clasp Adjustable
Plier TC.



DE-1423
Utility Plier Weingart TC.



DE-1424
Direct Bracket Remover
TC.



DE-1425
Straight Direct Bond Bracket
Remover TC.



DE-1426
Pin Holding Plier TC.



DE-1427
Hard wire cutters



DE-1428
Elastic Separating Plier
Round Handle



DE-1429
Elastic
Separating Plier



DE-1430
DE-1431
Smaha
Elastomeric
ligature
placing forceps
140 mm



DE-1432
Elastomeric
ligature placing
forceps with
groove
Falcon 140 mm



DE-1433
Elastomeric
ligature placing
forceps with
groove
Falcon 140 mm



Normal Anatomy – Dental Implants

Bone Level Normal
(No Bone Loss)

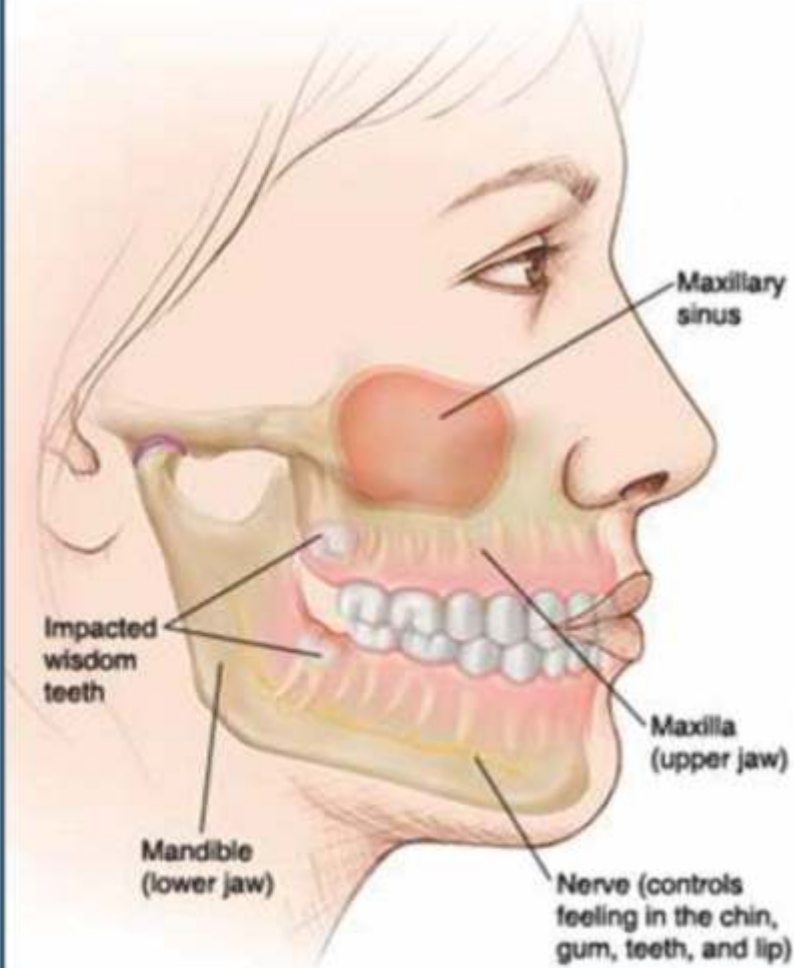
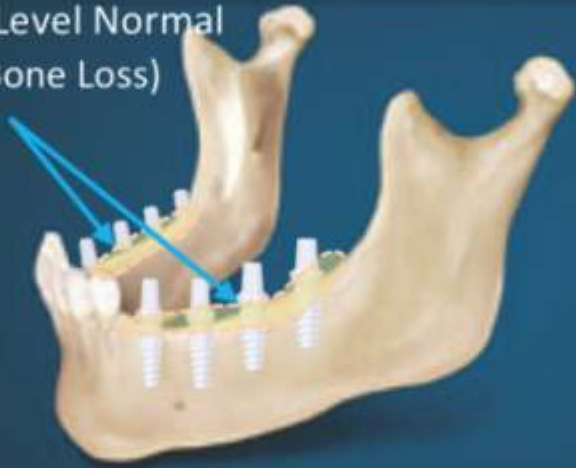

- Инструменты для имплантологии
- Implantologie
- Implantologie

- Інструменти для імплантології
- Implantologia
- زراعة الأسنان

IMPLANT GAGES



DE-1434
Multifunctional Meter
Length 90 mm,
different sizes,
8-10-11mm,
corrosion-resistant

DE-1435
Multifunctional Meter
Length 90 mm,
different sizes,
5-13-15-17 mm,
corrosion-resistant

DE-1436
Measuring Probe
Length 170 mm,
hand shape or flexible
(6-8-10-14-16 mm),
corrosion-resistant

DE-1437

DE-1438

DE-1439

DE-1440

IMPLANT GAGES



DE-1441

DE-1442

DE-1443

IMPLANTOLOGY

- Инструменты для имплантологии
 - Implantologie
 - Implantologie
- Інструменти для імплантології
 - Implantologia
 - زراعة الأسنان



DE-1444
Clamp, Osteometer
Length about 155 mm,
ridge width measurement,
two-sided scale,
measuring
range 0 - 25 mm



DE-1445
Measuring Loop
straight length 90 mm,
measuring range
0 - 40 mm,



DE-1446
Measuring Loop
angled, length 90 mm,
measuring range
0 - 40 mm,



DE-1447
Measuring loop, Castroviejo
angled, length 175 mm,
measuring range 0 - 40 mm,
with window



DE-1448
Boley Gauge
Stainless Steel



DE-1449
Measuring Loop
angled, length
175 mm,
measuring range
0 - 40 mm,



DE-1450
Measuring Loop
straight length
175 mm,
measuring range
0 - 40 mm,



DE-1451
Fig. 1
Iwanson
spring caliper
For metal and
porcelain.



DE-1452
Fig. 2
Iwanson
spring caliper
For wax.



DE-1453
Bone Thickness Gauge
40mm, 180mm



DE-1454
Gauge
for measuring
distances
(0 - 90 mm),



- Инструменты для имплантологии
- Implantologie
- Implantologie

- Інструменти для імплантології
- Implantologia
- زراعة الأسنان

BLACK TITANIUM COLOUR COATED INSTRUMENTS

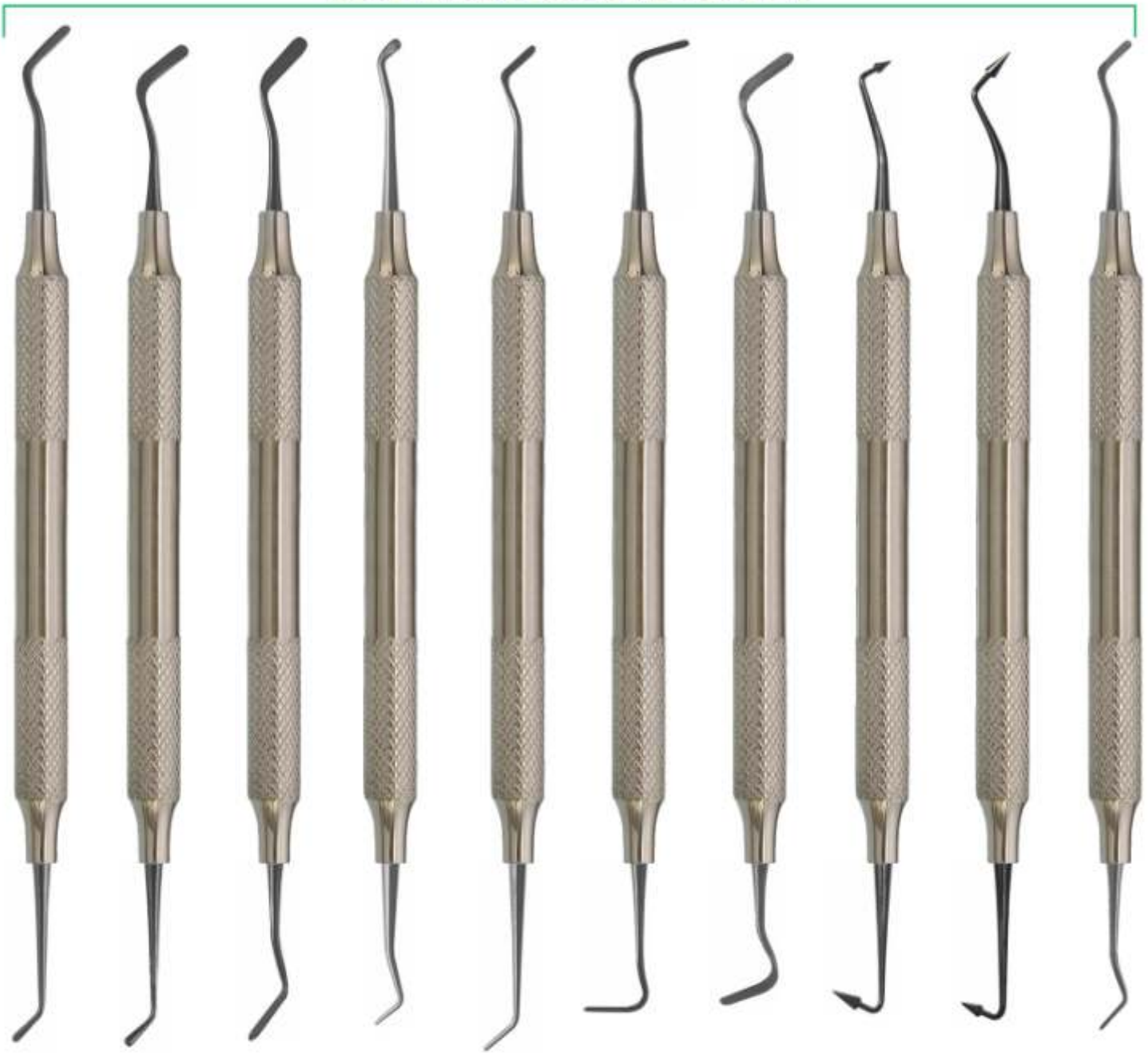

DE-1455 #1	DE-1456 #2	DE-1457 #3 Extra-Flex	DE-1458 Micro-Mini	DE-1459 Mini 1	DE-1460 Mini 4 Extra-Flex	DE-1461 #4 Extra-Flex	DE-1462 #5 Flexi-Thin	DE-1463 #6 Flexi-Thin	DE-1464 Mini 3 Extra-Flex
---------------	---------------	-----------------------------	-----------------------	-------------------	---------------------------------	-----------------------------	-----------------------------	-----------------------------	---------------------------------

IMPLANTOLOGY

- Инструменты для имплантологии
- Implantologie
- Implantologie
- Инструменти для имплантології
- Implantologia
- زراعة الأسنان

BLACK TITANIUM COLOUR COATED INSTRUMENTS

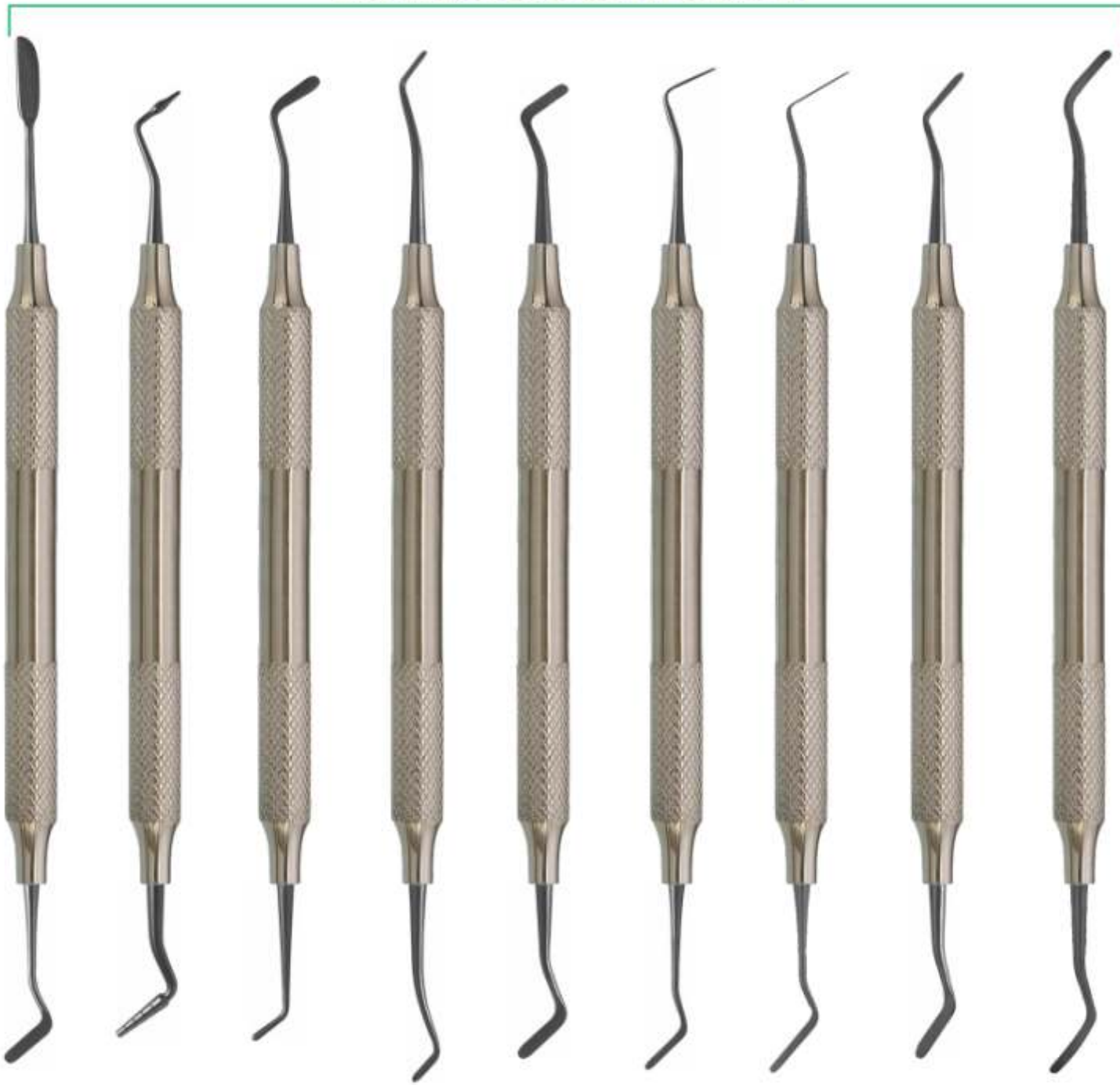

DE-1465
AB1
Boghosian

DE-1466
AB2
Boghosian

DE-1467
W3

DE-1468
8A

DE-1469
4/5
Gregg

DE-1470
Interproximal
Carver

DE-1471
Interproximal
Carver, Long

DE-1472
A6

DE-1473
Contouring
instrument



- Инструменты для имплантологии
 - Implantologie
 - Implantologie
- Инструменти для имплантології
 - Implantologia
 - زراعة الأسنان

BLACK TITANIUM COLOUR COATED INSTRUMENTS

BURNISHERS

FREEDMAN BURNISHERS

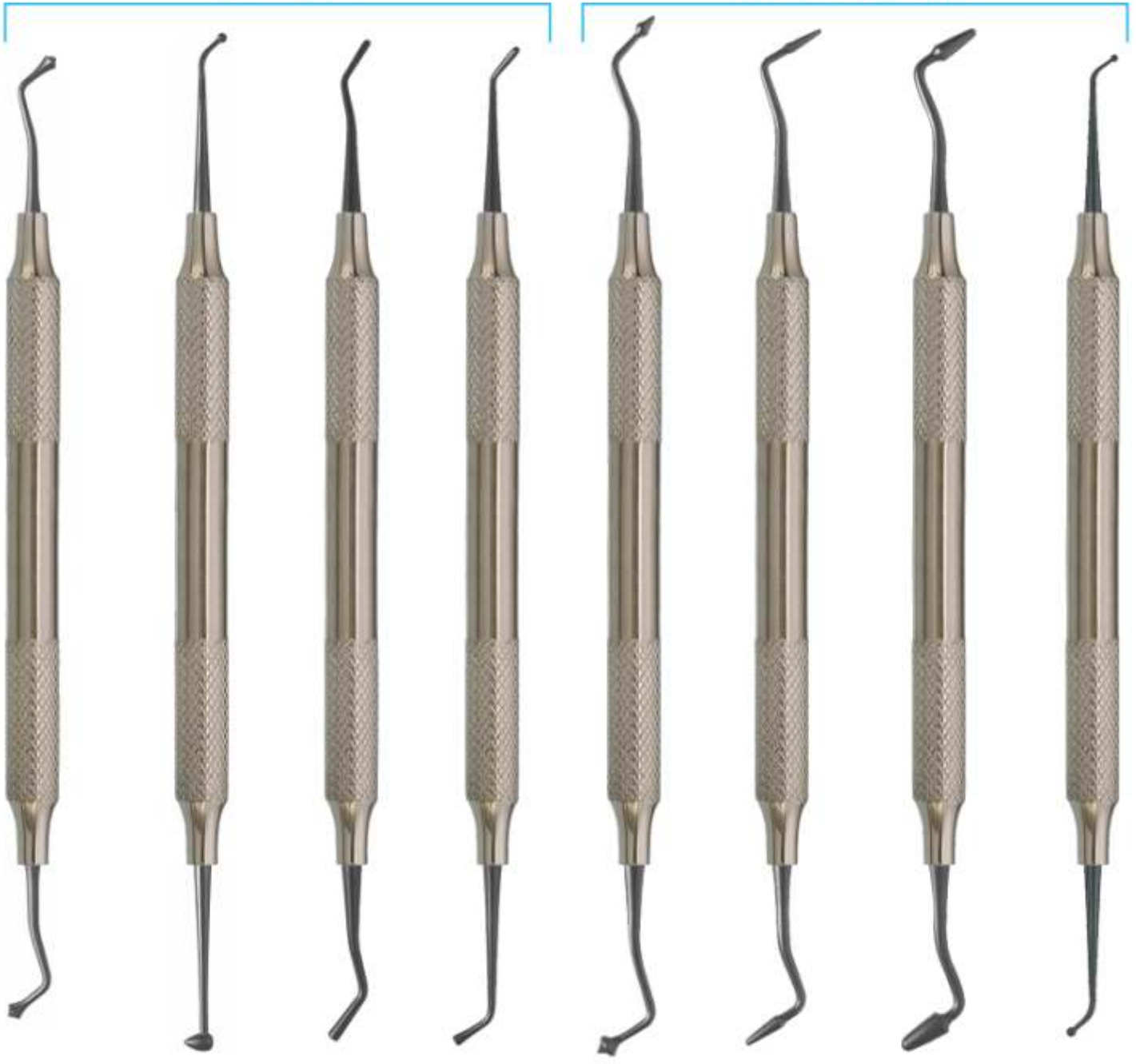

DE-1474
21B

DE-1475
27/29

DE-1476
2
Ladmore

DE-1477
3
Ladmore

DE-1478
Freedman
"Duckhead"

DE-1479
Freedman
Small Contact
Forming

DE-1480
Freedman
Large Contact
Forming

DE-1481
Small/
Medium Ball
Burnisher

IMPLANTOLOGY

- Инструменты для имплантологии
 - Implantologie
 - Implantologie
- Інструменти для імплантології
 - Implantologia
 - زراعة الأسنان

BLACK TITANIUM COLOUR COATED INSTRUMENTS

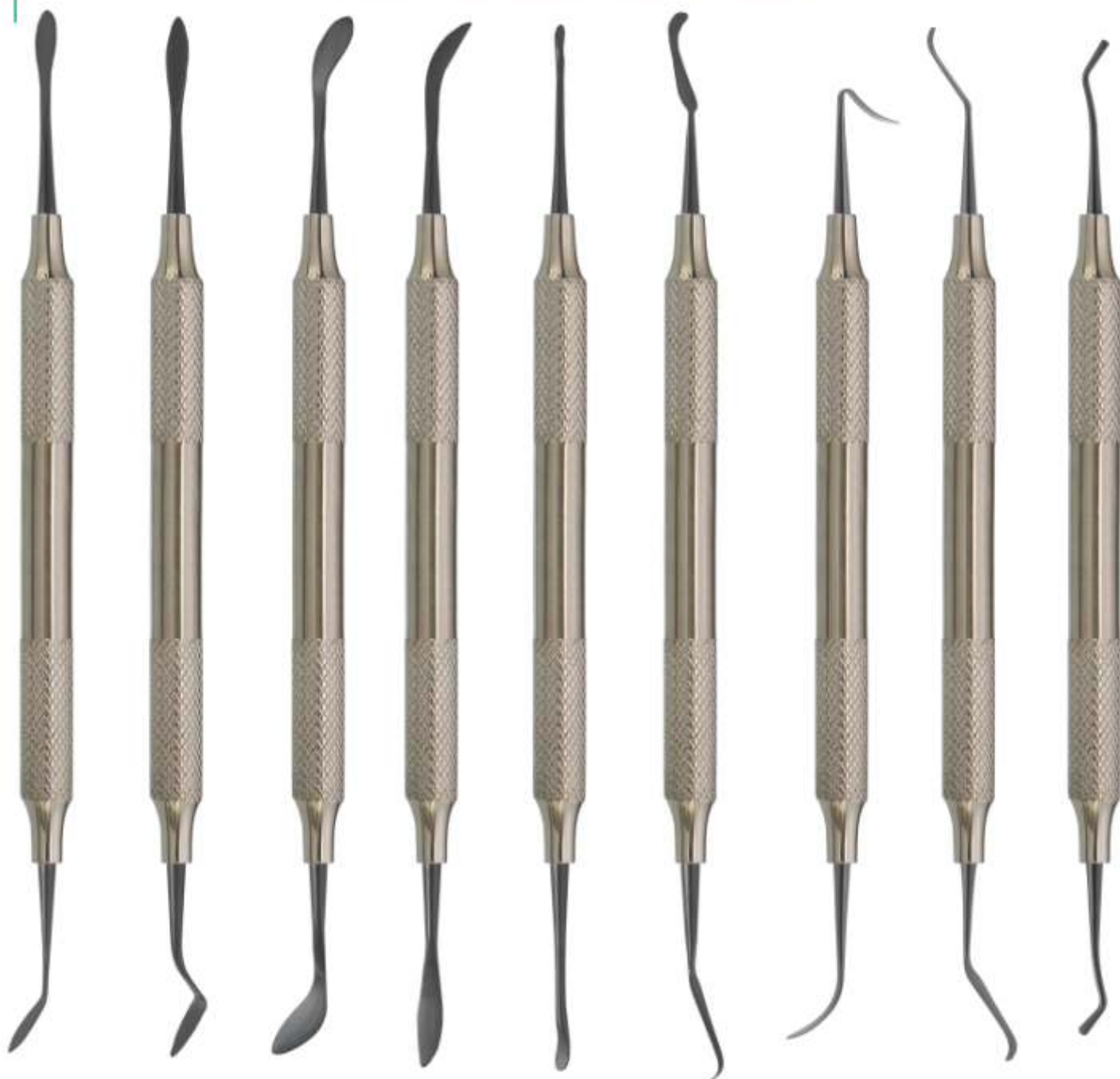

DE-1482
A
Cosmetic
Contouring

DE-1483
B
Cosmetic
Contouring

DE-1484
C
Cosmetic
Contouring

DE-1485
D
Cosmetic
Contouring

DE-1486
E
Cosmetic
Contouring

DE-1487
F
Cosmetic
Contouring

DE-1488
Marginal Ridge
& Embrasure
Shaping Instrument

DE-1489
Occlusal
Anatomy
Instrument

DE-1490
Composite
Packing
Instrument



IMPLANTOLOGY

- Инструменты для имплантологии
- Implantologie
- Implantologie
- Инструменти для имплантології
- Implantologia
- زراعة الأسنان

BLACK TITANIUM COLOUR COATED INSTRUMENTS

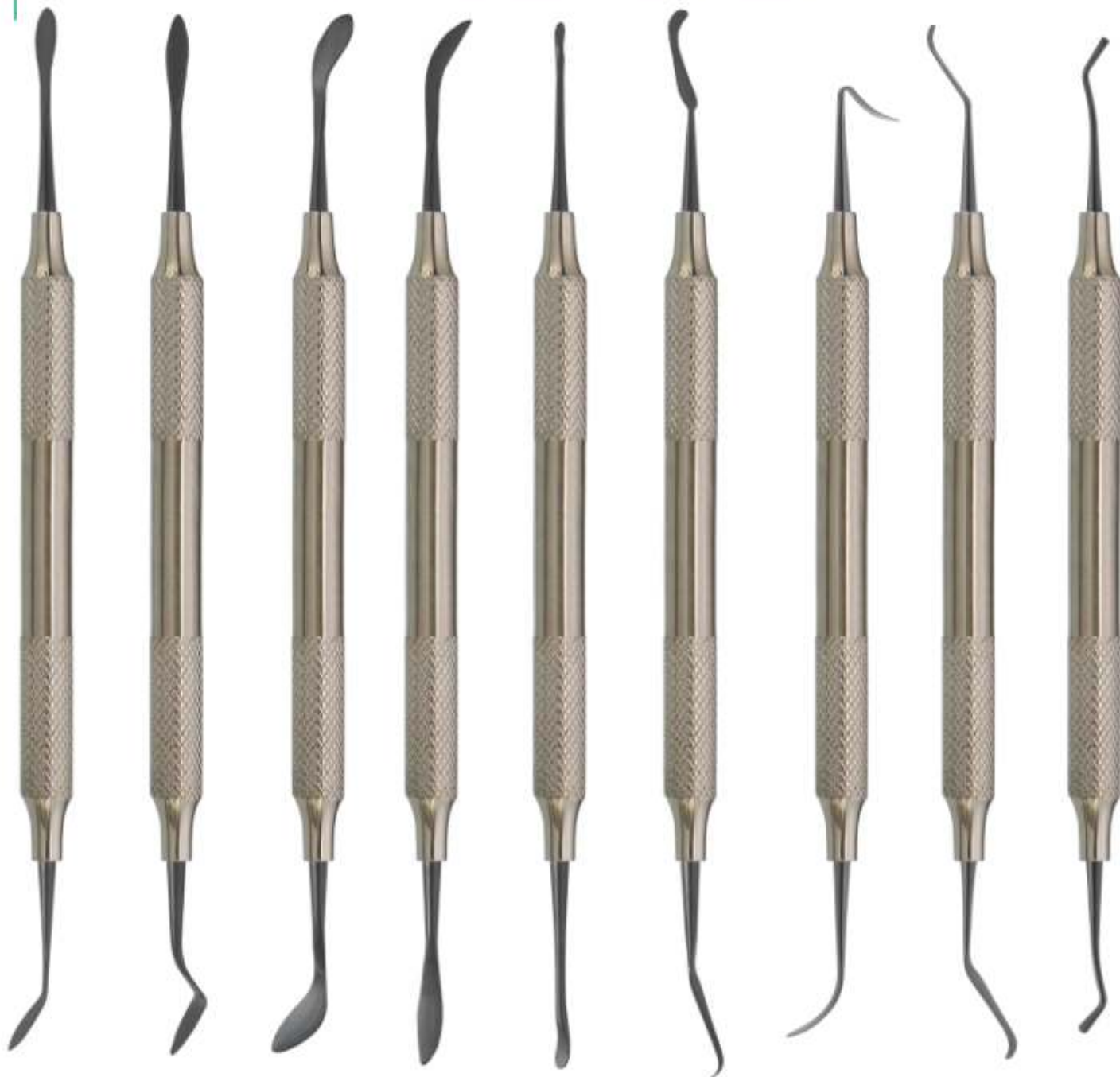

DE-1482
A
Cosmetic
Contouring

DE-1483
B
Cosmetic
Contouring

DE-1484
C
Cosmetic
Contouring

DE-1485
D
Cosmetic
Contouring

DE-1486
E
Cosmetic
Contouring

DE-1487
F
Cosmetic
Contouring

DE-1488
Marginal Ridge
& Embrasure
Shaping Instrument

DE-1489
Occlusal
Anatomy
Instrument

DE-1490
Composite
Packing
Instrument



- Инструменты для имплантологии
 - Implantologie
 - Implantologie
- Инструменти для имплантології
 - Implantologia
 - زراعة الأسنان

BLACK TITANIUM COLOUR COATED INSTRUMENTS

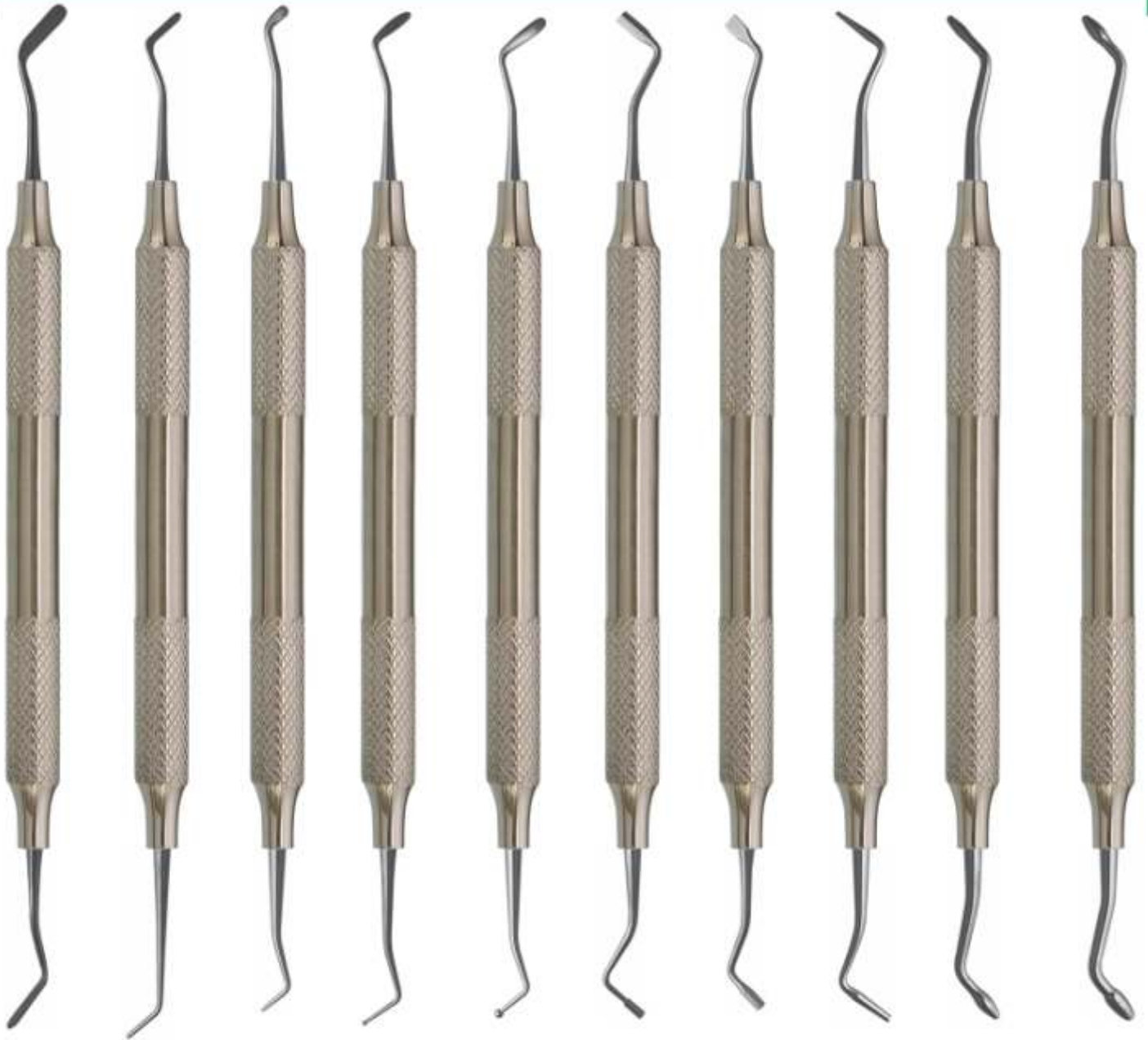

DE-1491 #3 Extra-Flex	DE-1492 Mini 1	DE-1493 Micro-Mini	DE-1494 Medium Placing/ Condensing	DE-1495 Large Placing/ Condensing	DE-1496 OT Tanner	DE-1497 3 Hollenback	DE-1498 5A	DE-1499 Small/Medium Contact Forming	DE-1500 Medium/Large Contact Forming
------------------------------------	--------------------------	------------------------------	--	---	--------------------------------	-----------------------------------	----------------------	--	--

IMPLANTOLOGY

- Инструменты для имплантологии
- Instrumente für Implantologie
- Implantsologie
- زراعة الأسنان

SINUS LIFT INSTRUMENTS HOLLOW HANDLE 9.5MM LENGTH 170MM

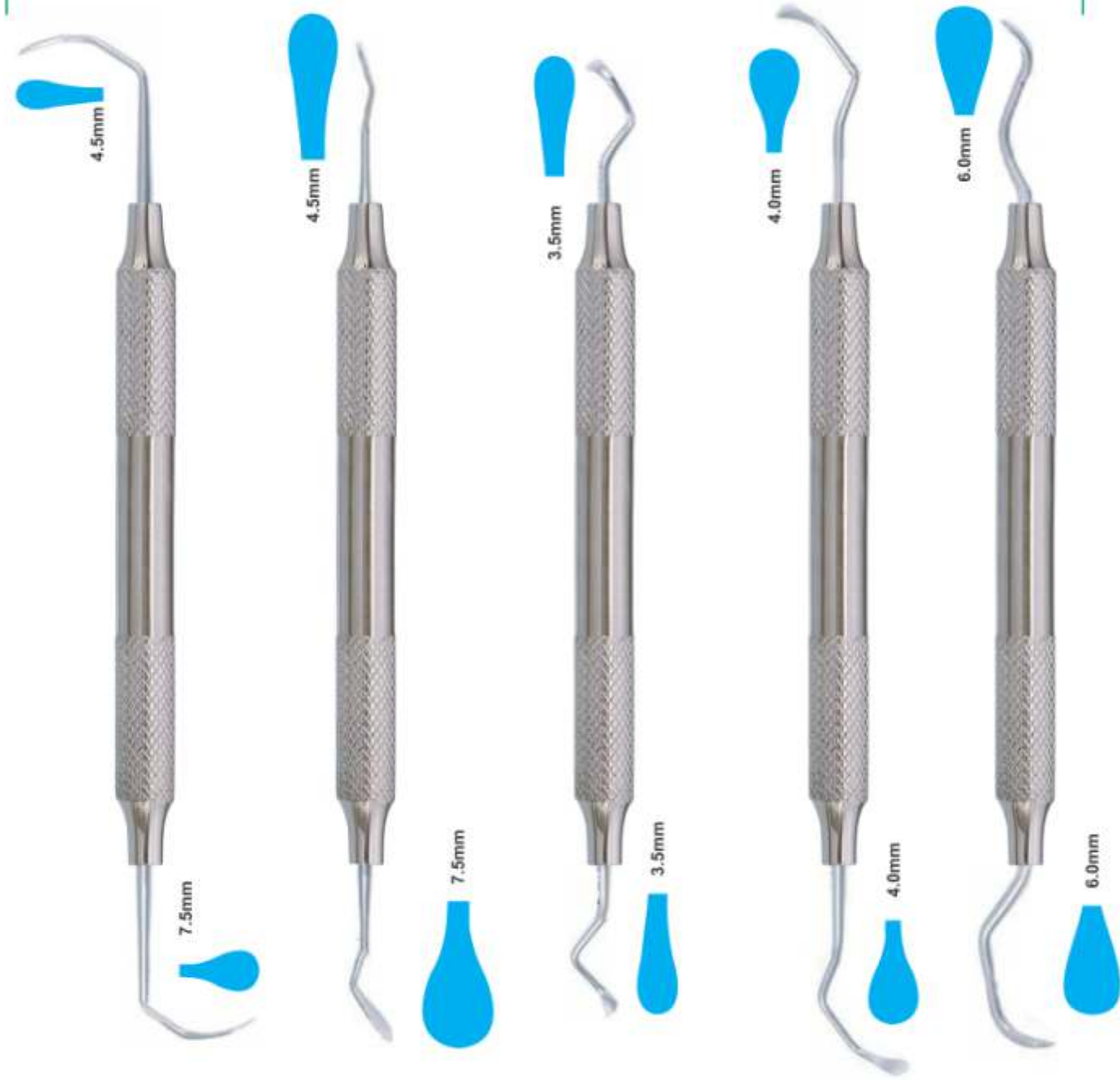

DE-1501
Sinus Lift Elevator

DE-1502
Sinus Lift Elevator

DE-1503
Sinus Lift Elevator

DE-1504
Sinus Lift Elevator

DE-1505
Sinus Lift Elevator



- Инструменты для имплантологии
- Implantologie
- Implantologie
- Инструменти для імплантології
- Implantologia
- زراعة الأسنان

SINUS LIFT INSTRUMENTS HOLLOW HANDLE 9.5MM LENGTH 170MM



DE-1506
Sinus Lift Elevator



DE-1507
Sinus Lift Elevator



DE-1508
Sinus Lift Elevator



DE-1509
Sinus Lift Elevator



IMPLANTOLOGY

- Инструменты для имплантологии
- Implantologie
- Implantologie
- Інструменти для імплантології
- Implantologia
- زراعة الأسنان

IMPLANT SINUS LIFT INSTRUMENTS HOLLOW HANDLE 9.5MM LENGTH 170MM

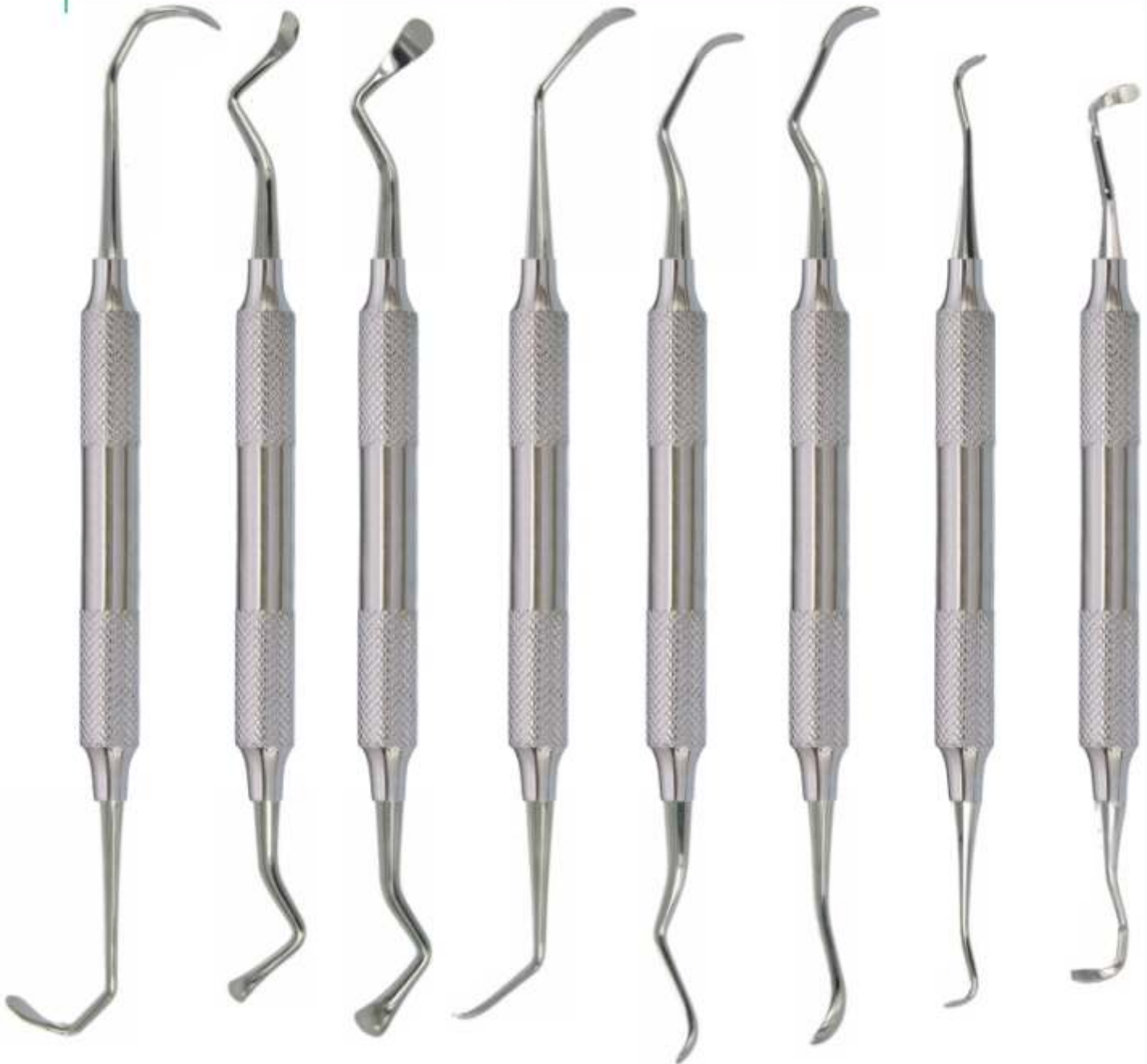

DE-1510
Acute 6577

DE-1511
Sinus1

DE-1512
Sinus2

DE-1513
Sinus3,
Obtuse 6578

DE-1514
Sinus4

DE-1515
Sinus5

DE-1516
Sinus6

DE-1517
Sinus7



- Инструменты для имплантологии
- Implantologie
- Implantologie
- Инструменти для имплантології
- Implantologia
- زراعة الأسنان

SINUS LIFT INSTRUMENTS HOLLOW HANDLE 9.5MM LENGTH 170MM

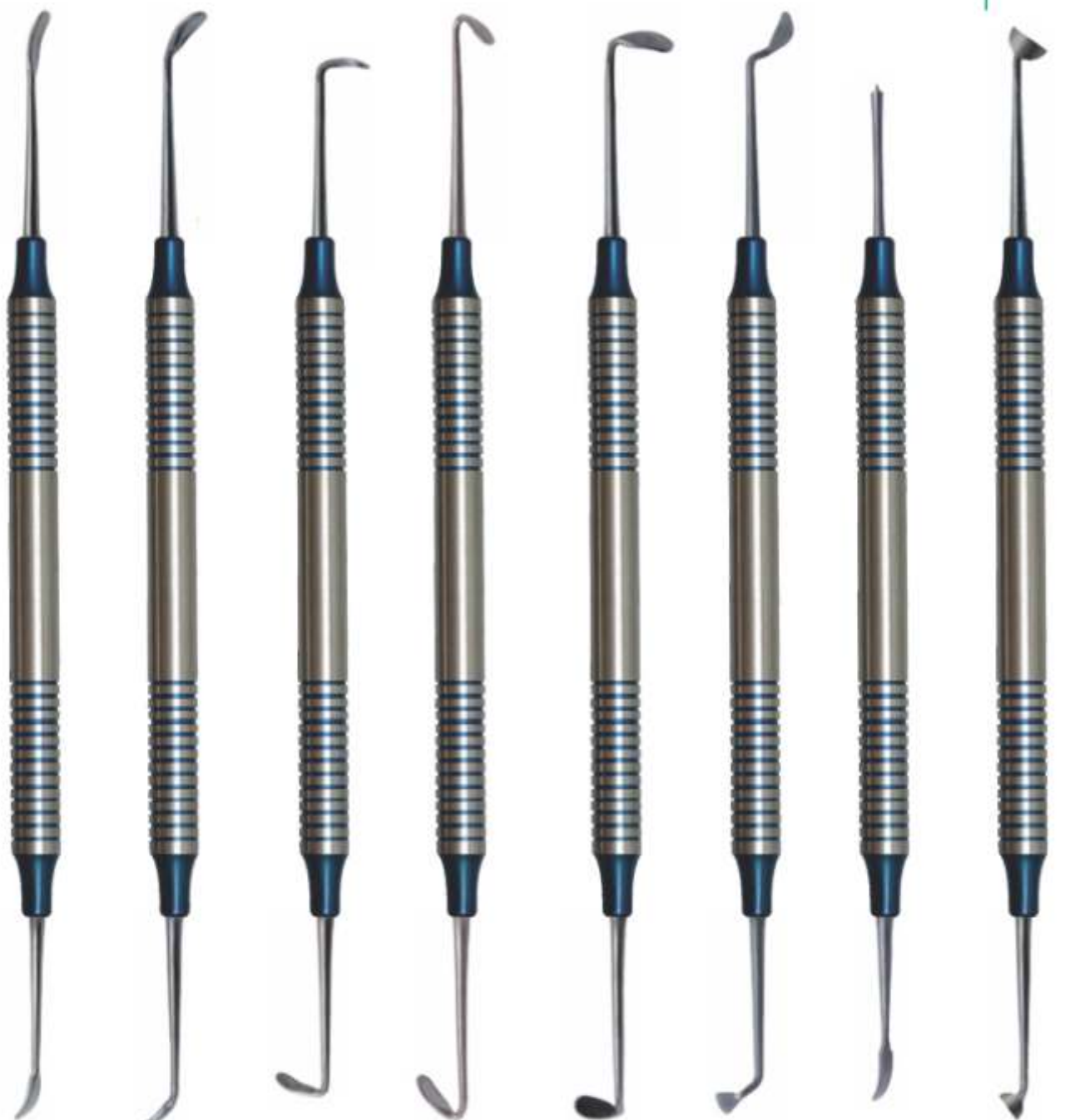

DE-1518 Sinuslift 1
DE-1519 Sinuslift 2
DE-1520 Sinuslift 3
DE-1521 Sinuslift 4
DE-1522 Sinuslift 5
DE-1523 Sinuslift 6
DE-1524 Membrane 3Positioning 1
DE-1525 Condenser 1

IMPLANTOLOGY

- Инструменты для имплантологии
 - Implantologie
 - Implantologie
- Інструменти для імплантології
 - Implantologia
 - زراعة الأسنان

Sinus Lift Instrument,
Flexible Sinus Lift Instruments
reduce the risk of perforation of the
"Schneider's membrane"



DE-1526 Fig. 1 DE-1527 Fig. 2 DE-1528 Fig. 3

Sinus Lift Elevator,
10 mm Straight grip
Length 175 mm, Sinus lift elevators, dull,
for gentle peeling and lifting the
Schneider membrane



DE-1529 Fig. 1 DE-1530 Fig. 2 DE-1531 Fig. 3

Sinus lift instrument
10 mm Straight grip Length 180 mm,
Buser (B1, B2, B3) raspatories,
quality medical stainless steel,
corrosion-resistant



DE-1532 B01 DE-1533 B02 DE-1534 B03



- Инструменты для имплантологии
 - Implantologie
 - Implantologie
- Інструменти для імплантології
 - Implantologia
 - زراعة الأسنان

Sinus lift instrument 10 mm Straight grip Sinus lift elevators, blunt or sharply curved (H01, H02, K03, K04, K78, K77)

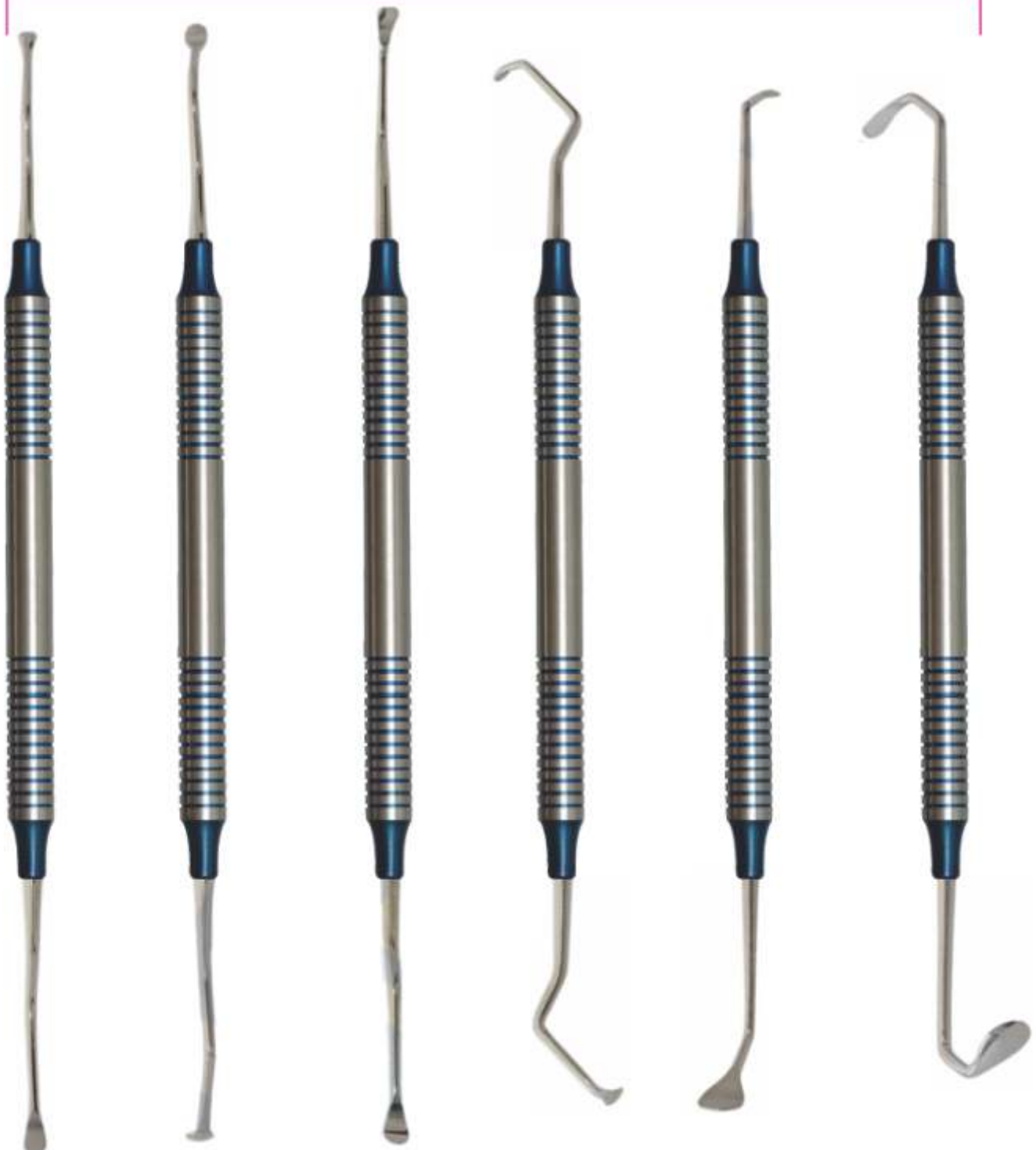
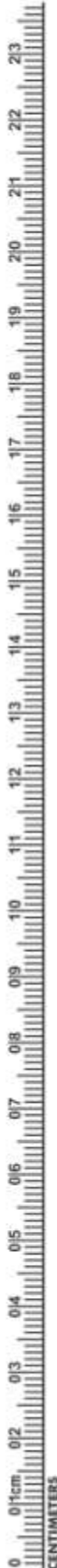

DE-1535
Sinus lift instrument
H01

DE-1536
Sinus lift instrument
H02

DE-1537
Sinus lift instrument
K03

DE-1538
Sinus lift instrument
K04

DE-1539
Sinus lift instrument
K78

DE-1540
Sinus lift instrument
K77

IMPLANTOLOGY

- Инструменты для имплантологии
- Implantologie
- Implantologie
- Інструменти для імплантології
- Implantologia
- زراعة الأسنان

SINUS LIFT INSTRUMENT

Sinus Lift Elevators, 10 mm Hollow Handle length 170mm Blunt Curved Set of 6 Pcs

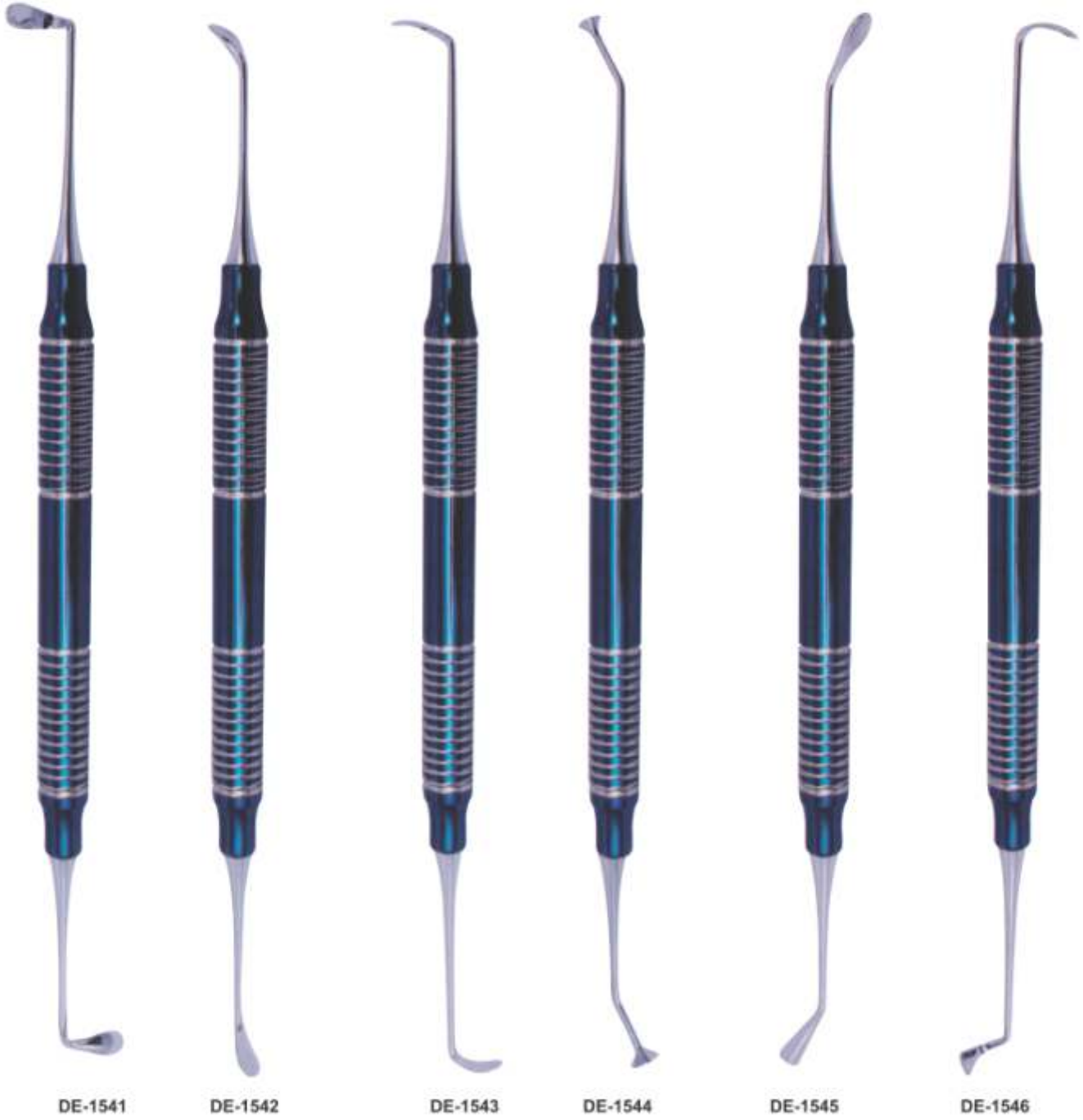

DE-1541

DE-1542

DE-1543

DE-1544

DE-1545

DE-1546

- Инструменты для имплантологии
- Instrumentologie
- Implantsologie
- Инструменти для имплантології
- Implantologia
- زراعة الأسنان

IMPLANT SINUS LIFT INSTRUMENTS
 PERIODONTAL SURGERY SURGICAL CHISELS
 KRAMER NEVINS SINUS LIFT

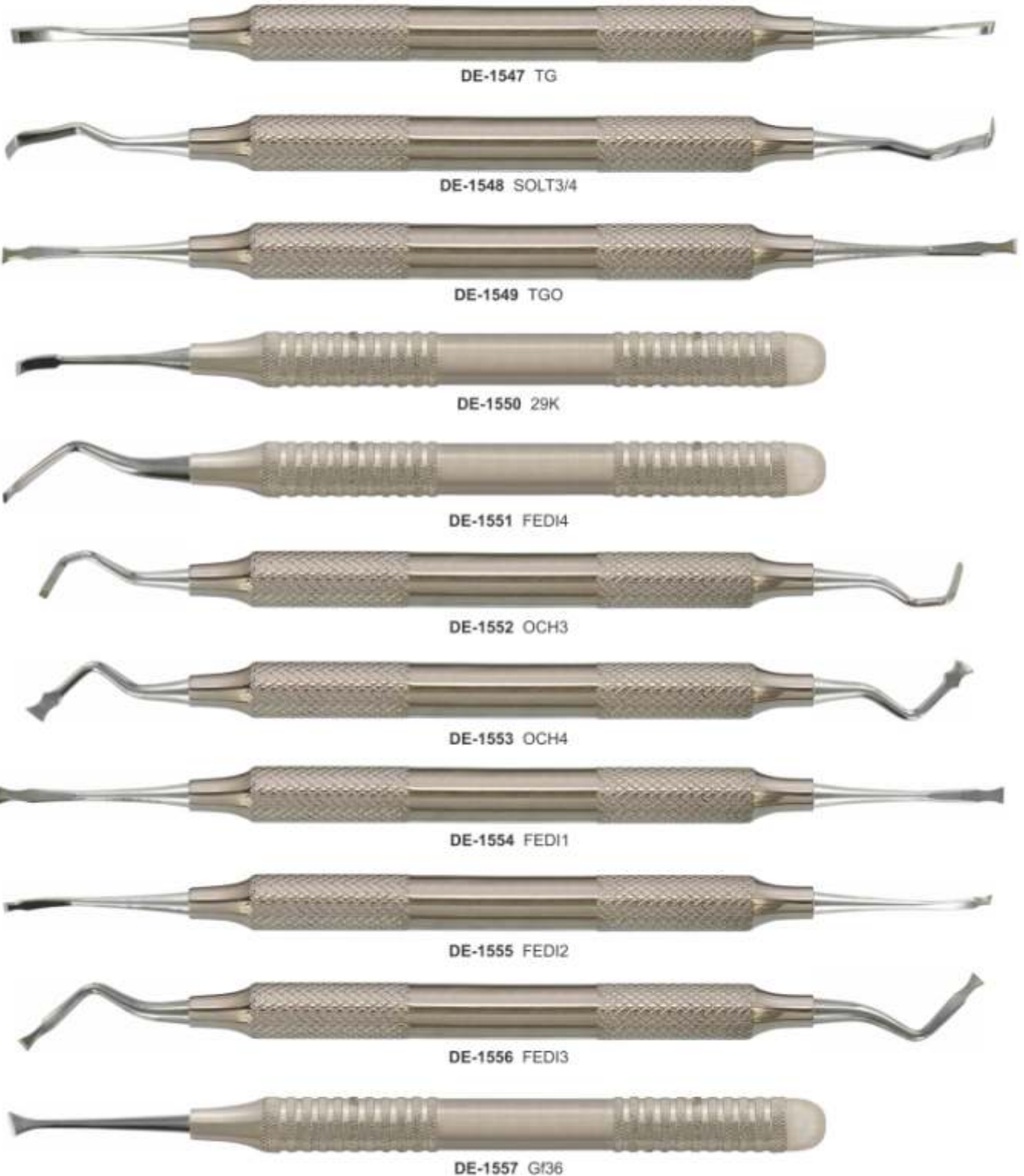

IMPLANTOLOGY

- Инструменты для имплантологии
- Implantologie
- Implantologie
- Інструменти для імплантології
- Implantologia
- زراعة الأسنان

IMPLANT

SURGICAL CHISELS

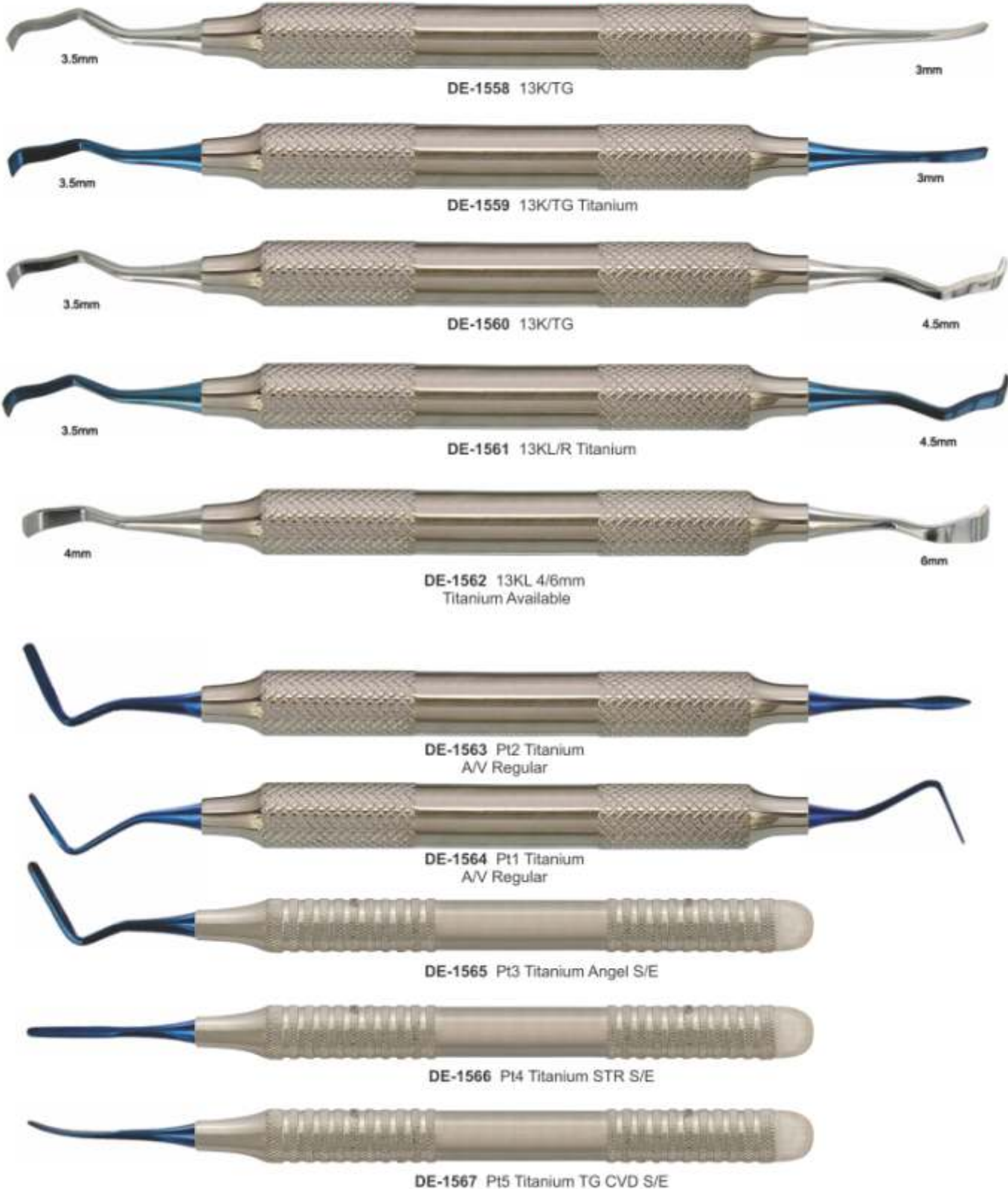

- Инструменты для имплантологии
- Implantologie
- Implantologie

- Інструменти для імплантології
- Implantologia
- زراعة الأسنان

MIXING SPATULA WITH SHOVEL



DE-1568
Bone Carrier
Titanium



DE-1569
Raspator, Prichard
Length 180 mm,
10 mm hollow handle,
double-ended
10.5 mm | 4.5 mm,



DE-1570
Raspator, Prichard
Length 180 mm,
10 mm hollow handle,
double ended



DE-1571
Raspator, Prichard
Length 180 mm,
10 mm hollow handle,
double-ended
10.5 mm | 4.5 mm,



DE-1572
Mixing Spatula
with shovel
17cm



DE-1573
Mixing Spatula
with shovel
18.5cm



IMPLANTOLOGY

- Инструменты для имплантологии
- Implantologie
- Implantologie
- Инструменти для имплантології
- Implantologia
- زراعة الأسنان

BONE GRAFTING INSTRUMENTS COMPACTOR /TAMPERS

Product offering includes instruments for harvesting, mixing and compacting bone Provides clinicians with the proper instrumentation for bone grafting procedures Weighted bone basin Prevents tipping and spilling of bone and other materials during mixing



DE-1574
Graft Packer,
Concave Tips
DE 4/6mm

DE-1575
Bone Spoon/
Packer DE 3mm

DE-1576
Graft Packer,
Serrated Tips
DE 6/8mm

DE-1577
Graft Packer,
Serrated Tips
DE 3/4mm

DE-1578
Graft Packer,
Smooth Tips
DE 5/8mm

DE-1579
Titanium graft packer/
placement site depth
gauge 3.3mm & 4.0mm
Diameter tips Marked
at 8, 11, 13, 15 & 18mm

DE-1580
Graft Material Spoon
Concave Tip For
Larger Grafts

- Инструменты для имплантологии
- Implantologie
- Implantologie

- Инструменти для имплантології
- Implantologia
- زراعة الأسنان

BONE GRAFTING INSTRUMENTS



DE-1581
Blade and pusher
Length 180 mm,
for straight or angled,
blade: 15 x 5 mm,
pusher: 4 mm diameter
Straight



DE-1582
Blade and pusher
Length 180 mm,
for straight or angled,
blade: 15 x 5 mm,
pusher: 4 mm diameter
angular



DE-1583
Spoon and pusher
Length 180 mm,
for angled spoon:
10 x 5 mm, pusher:
diameter 3 mm



DE-1584
Tunnelierungs
Instrument
length 175 mm,



DE-1585
Tunnelierungs
Instrument
length 175 mm,
different designs



DE-1586
Tamper
Length 170 mm,
for bone material,
double-ended,
diameter 3.2 mm
(2-4-6-8-10) and diameter
2.5mm (2-4-6-8-10)



IMPLANTOLOGY

- Инструменты для имплантологии
- Implantologie
- Implantologie
- Інструменти для імплантології
- Implantologia
- زراعة الأسنان

Pluggers Clarizio

Length 160 mm, with titanium tips for mixing and pouring of autologous, heterologous bone substitute material, diameter (3/4 or 6/8 mm)

BONE GRAFTING INSTRUMENTS



DE-1587 Ø 4mm
DE-1588 Ø 5mm
Compactor
150mm



DE-1589
Sinus Window
Bone Tampers
4 mm



DE-1590
Sinus Window
Bone Tampers
7 mm



DE-1591
6/8mm



DE-1592
3/4mm



- Инструменты для имплантологии
 - Implantologie
 - Implantologia
- Инструменти для имплантології
 - Implantologia
 - زراعة الأسنان

SPOON AND PUSHER (TRINOVO)

Trinovo handle, different workers, for bone material, high-grade medical stainless steel, corrosion-resistant

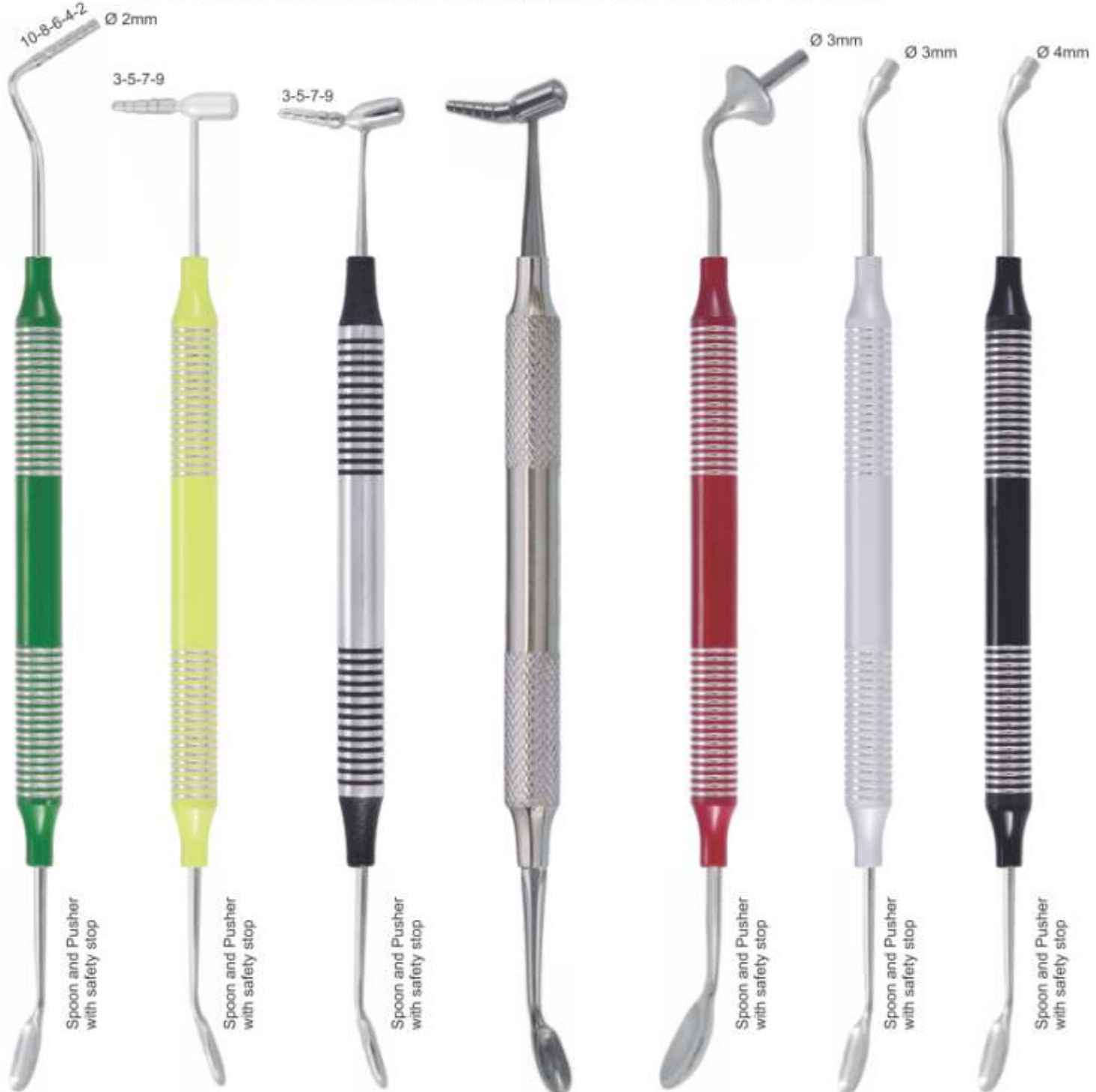

DE-1593
10x5mm

Spoon and Pusher
with safety stop

DE-1594
10x5mm

Spoon and Pusher
with safety stop

DE-1595
10x5mm

Spoon and Pusher
with safety stop

DE-1596
Bone Graft/Carrier
Titanium
2-4-6-8-10mm

DE-1597
15x10mm

Spoon and Pusher
with safety stop

DE-1598
10x5mm

Spoon and Pusher
with safety stop

DE-1599
10x5mm

Spoon and Pusher
with safety stop

- Инструменты для имплантологии
- Implantologie
- Implantologie
- Инструменти для імплантології
- Implantologia
- زراعة الأسنان

PERIOSTEALS ELEVATOR 10mm Hollow Handle



DE-1600
Raspator,
BonexScraper
Length 165 mm,
10 mm hollow
handle,
double-ended 6
mm / 4 mm,

DE-1601
Raspator,
Raspatory
Length 180 mm,
10 mm hollow
handle,
double-ended
3 mm | 3 mm,

DE-1602
Raspator,
Raspatory
Length 180 mm,
10 mm hollow
handle,
double-ended
3 mm | 3 mm,

DE-1603
Raspator,
Papilla
Length 185 mm,
10 mm hollow
handle,
double-ended
3 mm | 2 mm,

DE-1604
Raspator,
bone scraper
Length 175 mm,
10 mm hollow
handle,
double-ended,

DE-1605
Raspator,
micro-Freer
Length 180 mm,
6 mm solid grip,
double-ended
3 mm | 4 mm

DE-1606
Raspator,
Freer
Length 180 mm,
6 mm solid
handle,
double-ended
5 mm | 5 mm,

- Инструменты для имплантологии
- Implantologie
- Implantologie

- Інструменти для імплантології
- Implantologia
- زراعة الأسنان

PERIOSTEALS ELEVATOR 10mm Hollow Handle



DE-1607
Raspator,
Freer
10 mm hollow
handle,
high-quality
medical
double ended

DE-1608
Raspator,
Molt
Length 180 mm,
8 mm solid
grip,
double-ended
6 mm

DE-1609
Raspator,
micro Freer
Length 185 mm,
10 mm hollow
handle,
double-ended,

DE-1610
Raspator,
micro Freer
Length 185 mm,
10 mm hollow
handle,
double-ended,

DE-1611
Raspator, micro
Raspator /
chisel
Length 170 mm,
10 mm hollow
handle,
double-ended,

DE-1612
Raspator, micro
Raspator /
chisel
Length 175 mm,
10 mm hollow
handle,
double-ended,

DE-1613
Raspator,
Micro Raspator /
chisel
Length 175 mm,
8 mm solid handle,
double-ended
3.5mm | 3.5 mm,

IMPLANTOLOGY

- Инструменты для имплантологии
 - Implantologie
 - Implantologie
- Інструменти для імплантології
 - Implantologia
 - زراعة الأسنان

PERIOSTEALS ELEVATOR 10mm Hollow Handle



DE-1614
Raspatory Micro Molt
Length 175 mm,
corrosion-resistant

DE-1615
Raspatory Chipping
Workers:
Chisel 24G and 7.5 mm,
length about 175 mm,
corrosion-resistant

DE-1616
Raspatory MOLT
Work ends:
5.0 mm and 4.0 mm,
length about 175 mm,
corrosion-resistant

DE-1617
Rasp, Molt M9
Length 175 mm,
corrosion-resistant

DE-1618
Raspator, WAUTIER
Length 175 mm,
corrosion-resistant

DE-1619
Raspator, BENQUE
Length 170 mm,
workers
5 mm | 7 mm,
corrosion-resistant

DE-1620
Raspator, Nordberg
Length 180 mm,
8 mm hollow handle,
double-ended
6 mm | 4 mm

- Инструменты для имплантологии
- Instrumentologie
- Implantsologie
- Инструменти для імплантології
- Implantologia
- زراعة الأسنان

Hollow Handle 10mm Length 170mm



IMPLANTOLOGY

- Инструменты для имплантологии
- Implantologie
- Implantologie
- Інструменти для імплантології
- Implantologia
- زراعة الأسنان

TISSUE MEMBRANE FORCEPS



DE-1630
Tissue Graft Forcep
Serrated Teeth



DE-1631
Self Locking
Grooved



DE-1632
Tissue Graft Forcep
Serrated Teeth



DE-1633
Titanium
Locking Plier



DE-1634
TC Gripper Carbide
Tipped Tissue Forceps
Serrated Carbide Tips
14.5cm



DE-1635
Adson Carbide
Tipped Tissue Forceps
Serrated Carbide Tips
12cm



DE-1636
Micor Adson 1x2
Tissue Forcep 12.1cm
1x2 Teeth - 0.5mm Tips



DE-1637
Adson 7x7
Tissue Forceps
7x7 Teeth 12cm



DE-1638
Adson 7x7 Curved
Tissue Forceps
7x7 Teeth 12cm



DE-1639
Suture Pliers
Suture Forceps with
1.6mm Ring Tip



DE-1640
Debakey Atraumatic
Tissue Forceps Straight
Serrated Teeth
16cm



DE-1641
Debakey Atraumatic
Tissue Forceps Curved
Serrated Teeth
16cm



- Инструменты для имплантологии
- Implantologie
- Implantologie

- Инструменти для имплантології
- Implantologia
- زراعة الأسنان

TISSUE MEMBRANE FORCEPS



DE-1642
Russian Long
Tissue Forceps
Serrated Tip
20cm



DE-1643
Russian
Tissue Forceps
Serrated Tip
15cm



DE-1644
Tissue Punch Forceps
To Remove Tissue
After Using Punch



DE-1645
13.5 cm
narrow
Membrane tweezers KUEHNE



DE-1646
10.5 cm
Membrane tweezers KUEHNE



DE-1647
13.5 cm
wide



DE-1648
Pin-Tweezers
with or without lock,
length 15 cm,
with lock



DE-1649
without lock,



DE-1650
Haltepinzette with lock
15,5 cm, for pins, towards
the tips, etc.,



DE-1651
Carry Forceps
15cm



DE-1652
Carry Forceps
15cm



DE-1653
Carry Forceps
15cm

IMPLANTOLOGY

- Инструменты для имплантологии
- Implantologie
- Implantologia
- زراعة الأسنان

OSTEOTOME CONVEXES / CONCAVE / CONIQUES

CONVEXES



DE-1654
SET OF 5 PIECES

CONCAVES



DE-1655
SET OF 5 PIECES

CONIQUES



DE-1656
SET OF 5 PIECES

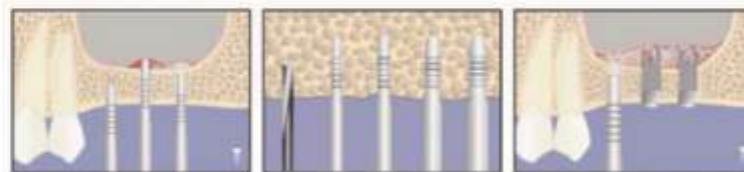

CONVEXES STRAIGHT	DE-1654	2,7 Ømm	3,2 Ømm	3,7 Ømm	4,2 Ømm	5 Ømm
CONCAVES STRAIGHT	DE-1655	2,7 Ømm	3,2 Ømm	3,7 Ømm	4,2 Ømm	5 Ømm
CONIQUES STRAIGHT	DE-1656	2,7 Ømm	3,2 Ømm	3,7 Ømm	4,2 Ømm	5 Ømm

- Инструменты для имплантологии
- Implantologie
- Implantsologie
- Instruments for implantology
- Implantologia
- زراعة الأسنان

OSTEOTOME CONVEXES / CONCAVE / CONIQUES

CONVEXES



DE-1657
SET OF 5 PIECES

CONCAVES



DE-1658
SET OF 5 PIECES

CONIQUES



DE-1659
SET OF 5 PIECES

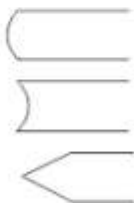
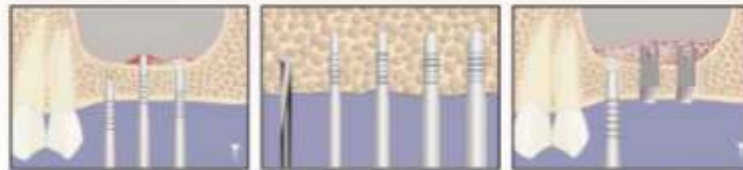

CONVEXES CURVED	DE-1657	2,7 Ømm	3,2 Ømm	3,7 Ømm	4,2 Ømm	5 Ømm
CONCAVES CURVED	DE-1658	2,7 Ømm	3,2 Ømm	3,7 Ømm	4,2 Ømm	5 Ømm
CONIQUES CURVED	DE-1659	2,7 Ømm	3,2 Ømm	3,7 Ømm	4,2 Ømm	5 Ømm



IMPLANTOLOGY

- Инструменты для имплантологии
 - Implantologie
 - Implantologie
- Інструменти для імплантології
 - Implantologia
 - زراعة الأسنان

TREPHINE

Burs with depth markings are suited for precise and simple transplantation of cylindrical bone grafts as well as for all other bone-extraction tasks.



DE-1660 Ø Int. 2 mm Ø Ext. 3 mm	DE-1661 Ø Int. 3 mm Ø Ext. 3.5 mm	DE-1662 Ø Int. 4 mm Ø Ext. 5 mm	DE-1663 Ø Int. 5 mm Ø Ext. 6 mm	DE-1664 Ø Int. 6 mm Ø Ext. 7 mm	DE-1665 Ø Int. 7 mm Ø Ext. 8 mm	DE-1666 Ø Int. 8 mm Ø Ext. 9 mm	DE-1667 Ø Int. 9 mm Ø Ext. 10 mm	DE-1668 Ø Int. 10 mm Ø Ext. 11 mm
--	--	--	--	--	--	--	---	--



DE-1669
Tissue Punch with pin
Set of Four Pieces



DE-1670
Tissue Punch
Set of Five Pieces



DE-1671
Tissue Punch
Set of Five Pieces



DE-1672
Trephine Drill
Set of Eight Pieces



DE-1673 Short Implant Drills	DE-1674 Long Implant Drills
--	---------------------------------------



DE-1675
Trephine Drill
Set of Eight Pieces



- Инструменты для имплантологии
- Implantologie
- Implantsologie
- زراعة الأسنان



BONE SCRAPER STRAIGHT & CURVED



DE-1676
Bone Scraper
Straight

DE-1677
Bone Scraper
Curved

TISSUE PUNCH STRAIGHT & CURVED

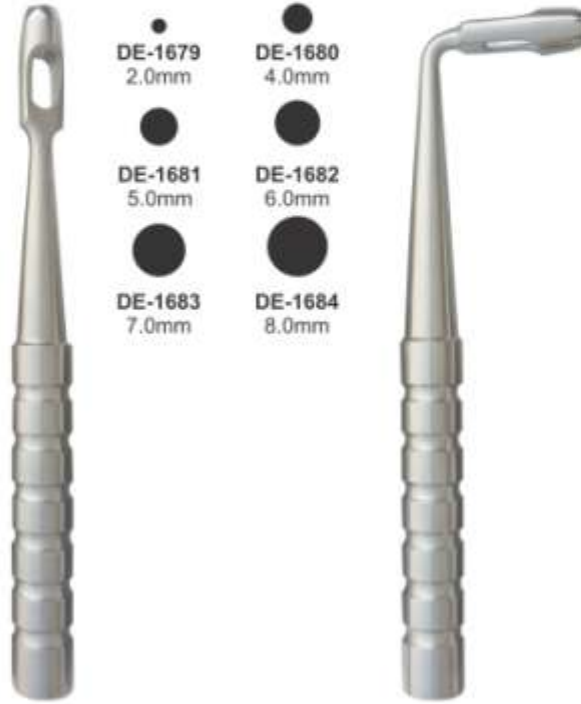

DE-1678
Tissue Punch
Straight

DE-1685
Tissue Punch
Curved

●	●	●	●
DE-1679 2.0mm	DE-1680 4.0mm	DE-1686 2.0mm	DE-1687 4.0mm
●	●	●	●
DE-1681 5.0mm	DE-1682 6.0mm	DE-1688 5.0mm	DE-1689 6.0mm
●	●	●	●
DE-1683 7.0mm	DE-1684 8.0mm	DE-1690 7.0mm	DE-1691 8.0mm



DE-1692
Bone Mill

DE-1693
Basins For Bone



BONE CRUSHER
DE-1694

IMPLANTOLOGY

- Инструменты для имплантологии
- Implantologie
- Implantologie
- Інструменти для імплантології
- Implantologia
- زراعة الأسنان

KEYS FOR IMPLANT SCREW



DE-1695



DE-1696



DE-1697



DE-1698

TORQUE WRENCH & RATCHET



DE-1699 Star Torque Wrench 6.35mm Universal



DE-1700 Round Torque Wrench 4.0mm Universal



DE-1701 Hex Driver With 4.0mm Driver



DE-1702 Star Torque Wrench 6.35mm Universal



DE-1703 Hex Torque Wrench 4.00mm Universal



DE-1704 Star Torque Wrench 6.35mm Universal



DE-1705 Star Torque Wrench 6.35mm Universal



DE-1706 Star Torque Wrench 6.35mm Universal



DE-1707 Star Torque Wrench 6.35mm Universal



DE-1708 Star Torque Wrench 6.35mm Universal



DE-1709 Star Ratchet Wrench 6.35mm Universal



DE-1710 Star Ratchet Wrench 6.35mm Universal



DE-1711 Star Ratchet Wrench 6.35mm Universal



DE-1712 Star Ratchet Wrench 4.0mm Universal



DE-1713 Round Ratchet Wrench 4.0mm Universal



DE-1714 Round Ratchet Wrench 3.35mm Universal



DE-1715 Star Ratchet Wrench 4.0mm Universal



DE-1716 Star Ratchet Wrench 6.35mm Universal



- Инструменты для имплантологии
- Instrumentologie
- Implantologie
- Инструменти для имплантології
- Implantologia
- زراعة الأسنان

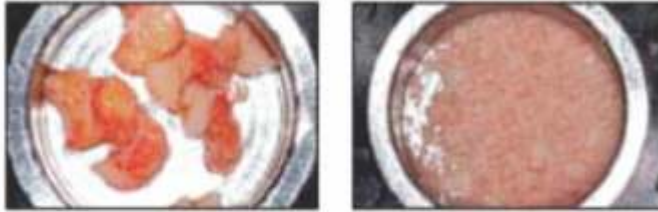

**DE-1717
BONE CRUSHER**
Titanium Metal Cutter

mallet



**DE-1718
BONE CRUSHER**
Titanium Metal Cutter

mallet



**DE-1719
BONE CRUSHER**



**DE-1720
BONE CRUSHER**
Bone Grinding Grain
1.5mm, 2mm, 2.5mm



**DE-1721
BONE CRUSHER**
Bone Grinding Grain
1.5mm, 2mm, 2.5mm



IMPLANTOLOGY

- Инструменты для имплантологии
- Implantologie
- Implantologie
- Инструменти для имплантології
- Implantologia
- زراعة الأسنان

BONE EXPANDER SCREW & SURGICAL KITS



DE-1722
 Bone Universal Kit
 Drill: 2mm, 2.8mm, 3.2mm, 3.65mm,
 4.2mm, 4.5mm, 4.8mm, 5.2mm
 Trephines Bit:
 3.0mm, 4.0mm, 5.0mm, 6.0mm,
 7.0mm, 8.0mm, 9.0mm, 10mm.
 Driver:
 2.5mm, 2.5mm Hand Pcs
 1.25mm, 1.25mm Hand Pcs
 Short Driver 2.5mm
 Long Driver 2.5mm
 1.25mm, Short Hex Driver Hand Pcs
 1.25mm, Long Hex Driver Hand Pcs
 Torque Wrench 4.0mm



DE-1723
 Bone Expander Kit
 Expander: 2.6mm, 3.0mm,
 3.4mm, 3.8mm, 4.3mm
 Ratchet Driver
 Parallel Pin
 Pilot Drill
 Drill 1.4mm
 Drill Driver 4mm
 Hand Driver 4mm
 Ratchet 4.0mm



DE-1724
 Bone Universal Kit
 Drill: 2mm, 2.8mm, 3.2mm, 3.65mm,
 4.2mm, 4.5mm, 4.8mm, 5.2mm
 Trephines Bit:
 3.0mm, 4.0mm, 5.0mm, 6.0mm,
 7.0mm, 8.0mm, 9.0mm, 10mm.

Bone Compression:
 2mm, 3.3mm, 2.8mm, 4.2mm, 3mm, 3.5mm
 Driver:
 2.5mm, 2.5mm Hand Pcs
 1.25mm, 1.25mm Hand Pcs
 Short Driver 2.5mm
 Long Driver 2.5mm
 1.25mm, Short Hex Driver Hand Pcs
 1.25mm, Long Hex Driver Hand Pcs
 Torque Wrench 6.35mm 1 Pcs



DE-1725
 Conical Drills: 20 Pcs
 Tissue Punches:
 3.0mm, 3.50mm, 4.0mm, 4.5mm,
 5.0mm, 6.0mm, 6.50mm
 Bone Expander:
 1.6/3.8mm, 1.9/3.0mm, 2.1/3.6mm,
 2.6/3.8mm, 2.9/4.3mm
 Drill Adapter: 1 Pcs
 1.25mm, 2.50mm Hex Driver Hand Pcs

Pilot Drill: 1.6mm
 Drill Bit: 1.4mm, 1.6mm, 1.8mm, 2.0mm, 2.2mm
 Ratchet Driver: 4mm/6.35, 1.25/2.50
 Rimer: 3.2/4.7mm, 3.7/4.7mm
 Parallel Pin: 4.5mm, 2.5mm
 Double step Drill: 2.4/2.8mm
 Depth Gauge: 1 Pcs
 Torque Wrench 6.35mm Universal: 1 Pcs



- Инструменты для имплантологии
 - Implantologie
 - Implantologie
- Инструменти для имплантології
 - Implantologia
 - زراعة الأسنان

BONE INJECTORS, COLLECTORS & SUCTION TUBE



DE-1726
Ø 2,5mm / 3,5mm
170mm

DE-1727
Ø 4,5mm / 5,5mm
170mm

DE-1728
Ø 3,5mm / 4,5mm
170mm

DE-1729
Ø 6,0mm / 7,0mm
170mm



DE-1730
18cm
Straight / Bend
I.D 2.5mm
O.D 3.5

DE-1731
18cm
Straight / Bend
I.D 3.5mm
O.D 4.5

DE-1732
18cm
Straight / Bend
I.D 4.5mm
O.D 5.5

DE-1733
18cm
Straight / Bend
I.D 6.0mm
O.D 7.0



DE-1734
17.5cm

DE-1735
18cm

DE-1736
coarse
Ø 5mm

DE-1737
fine
Ø 9mm

Suction tubes to collect the extracted bone material 180mm



DE-1738
Suction Tubes
180mm

DE-1739
Suction Tubes
180mm

DE-1740
Suction Tubes
180mm



DE-1741
Fig. 6FR
Frazier
15 cm - Ø 2 mm

DE-1742
Ø 3 mm
length 180mm

DE-1743
Ø 4 mm
length 180mm

DE-1744
Ø 5 mm
length 180mm

IMPRESSION TRAYS

- Оттисные ложки
- Porte-empainte
- Abdrucklöffel
- Відбиткові ложки
- Cubetas para impresiones
- صواني الانطباع

PERFORATED WITH RIM LOCK Set of 06 Pcs

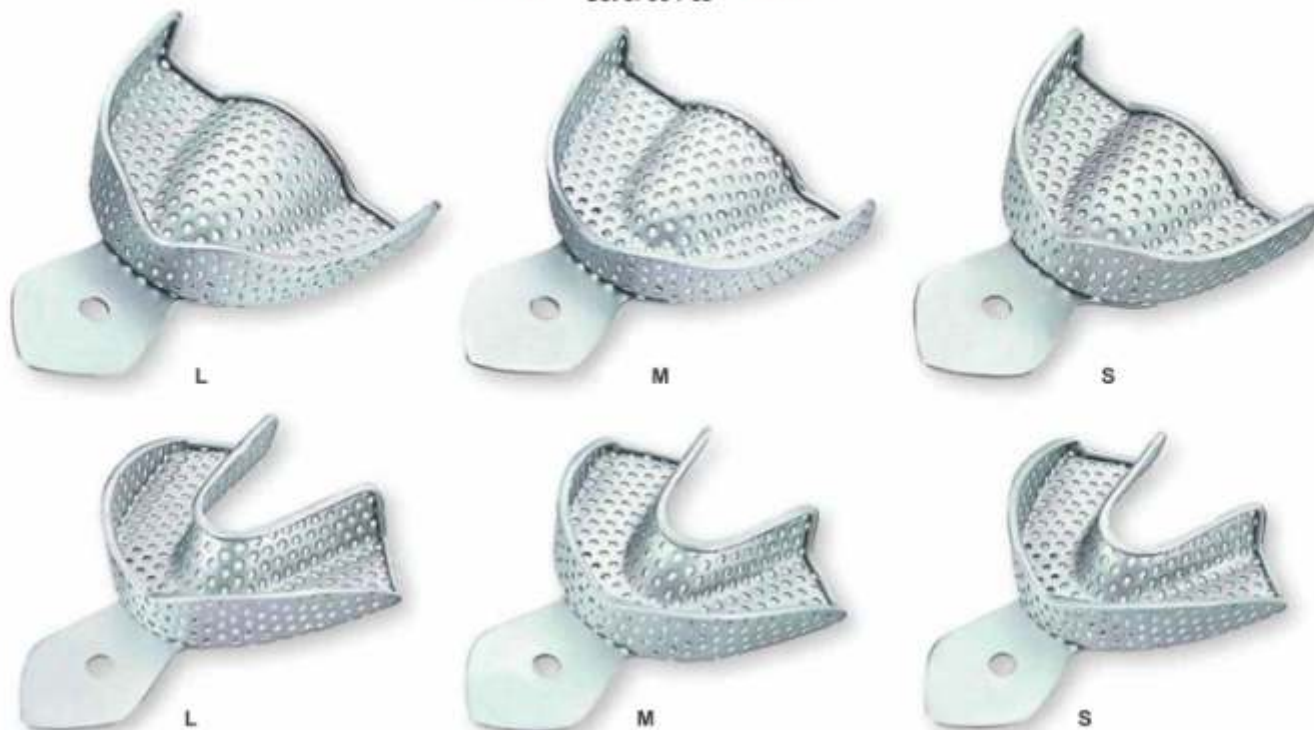

DE-1745 SET OF 06 PCS
Upper: S, M, L
Lower: S, M, L

PERFORATED WITH RIM LOCK Set of 8 Pcs



DE-1746 SET OF 08 PCS
Upper: XS, S, M, L
Lower: XS, S, M, L

DE-1747 SET OF 08 PCS
Upper: S, M, L, XL
Lower: S, M, L, XL

DE-1748 SET OF 10 PCS
Upper: XS, S, M, L, XL
Lower: XS, S, M, L, XL



- Оттисные ложки
 - Porte-empreinte
 - Abdrucklöffel
- Відбиткові ложки
 - Cubetas para impresiones
 - صواني الانطباع

SOLID WITH RIM LOCK

Set of 6 Pcs



L



M



S



L



M



S

DE-1749 SET OF 06 PCS

Upper: S, M, L
Lower: S, M, L

SOLID WITH RIM LOCK

Set of 8 Pcs



L



M



S



XS



L



M



S



XS

DE-1750 SET OF 08 PCS

Upper: XS, S, M, L
Lower: XS, S, M, L

DE-1751 SET OF 08 PCS

Upper: S, M, L, XL
Lower: S, M, L, XL

DE-1752 SET OF 10 PCS

Upper: XS, S, M, L, XL
Lower: XS, S, M, L, XL



IMPRESSION TRAYS

- Оттисные ложки
- Відбиткові ложки
- Porte-empreinte
- Cubetas para impresiones
- Abdrucklöffel
- صواني الاطباع

PERFORATED FULL DENTURE Set of 8 Pcs

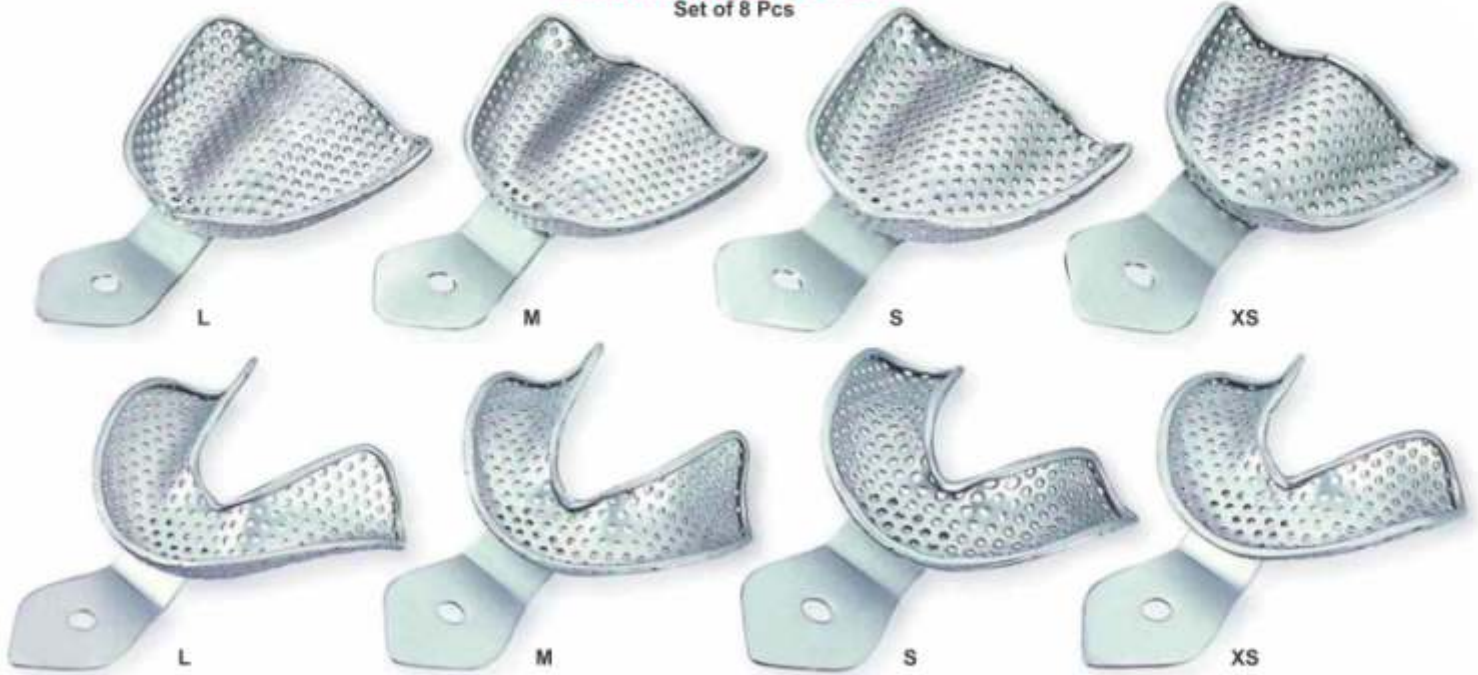

DE-1753 SET OF 08 PCS
Upper: S, M, L, XL
Lower: S, M, L, XL

DE-1754 SET OF 08 PCS
Upper: S, M, L
Lower: S, M, L

SOLID FULL DENTURE Set of 8 Pcs

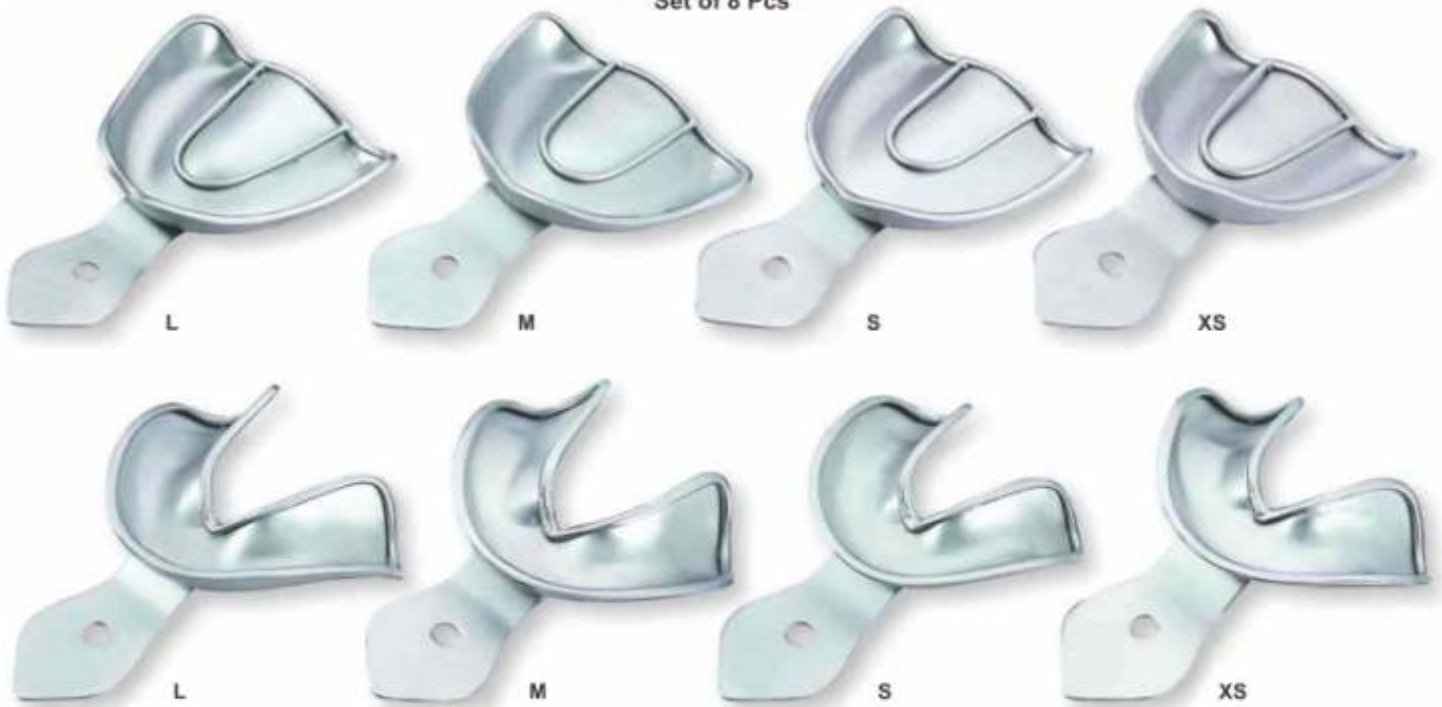

DE-1755 SET OF 08 PCS
Upper: S, M, L, XL
Lower: S, M, L, XL

DE-1756 SET OF 06 PCS
Upper: S, M, L
Lower: S, M, L



- Оттисные ложки
 - Porte-empreinte
 - Abdrucklöffel
- Відбиткові ложки
 - Cubetas para impresiones
 - صواني الانطباع

Perforated Without Rim Lock

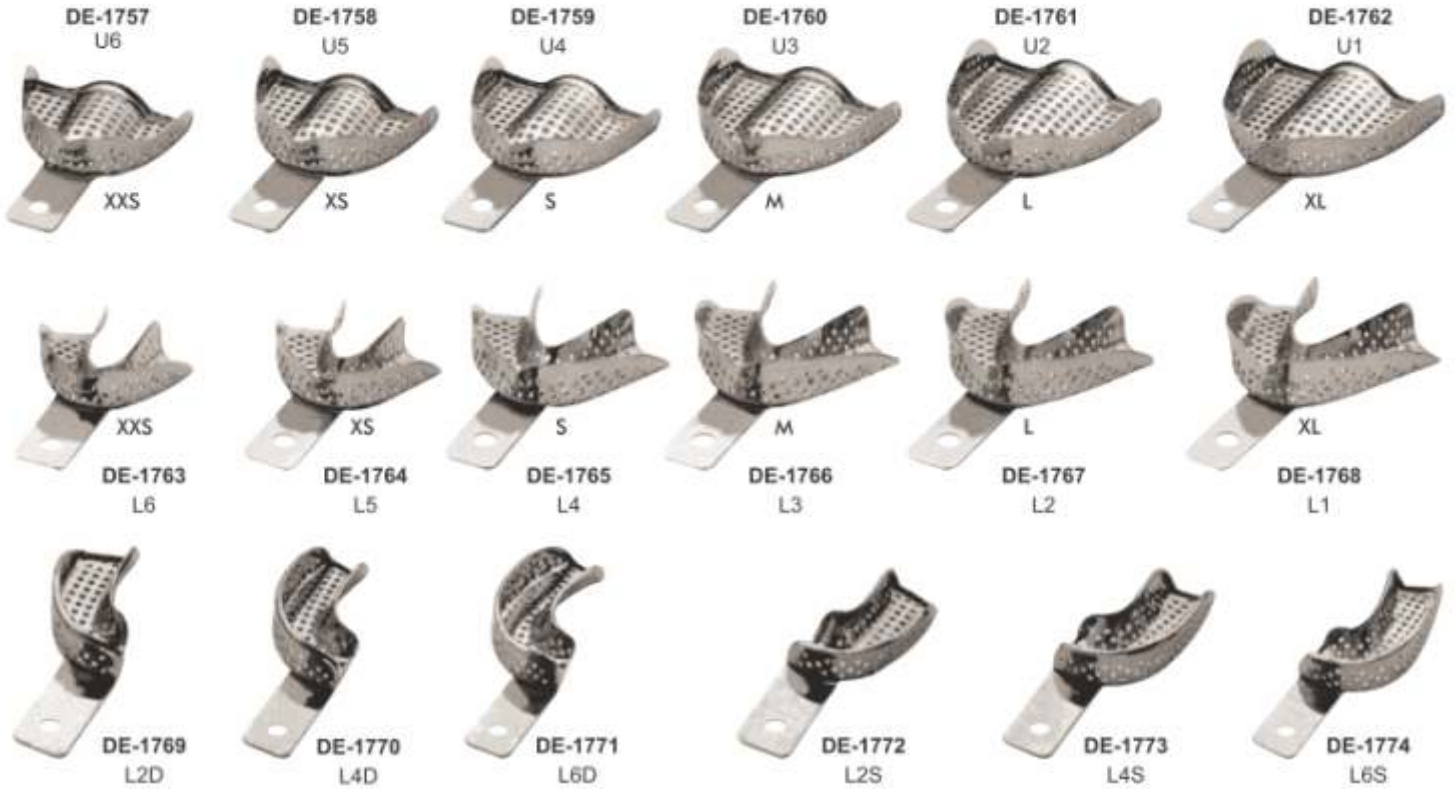

Solid With Rim Lock

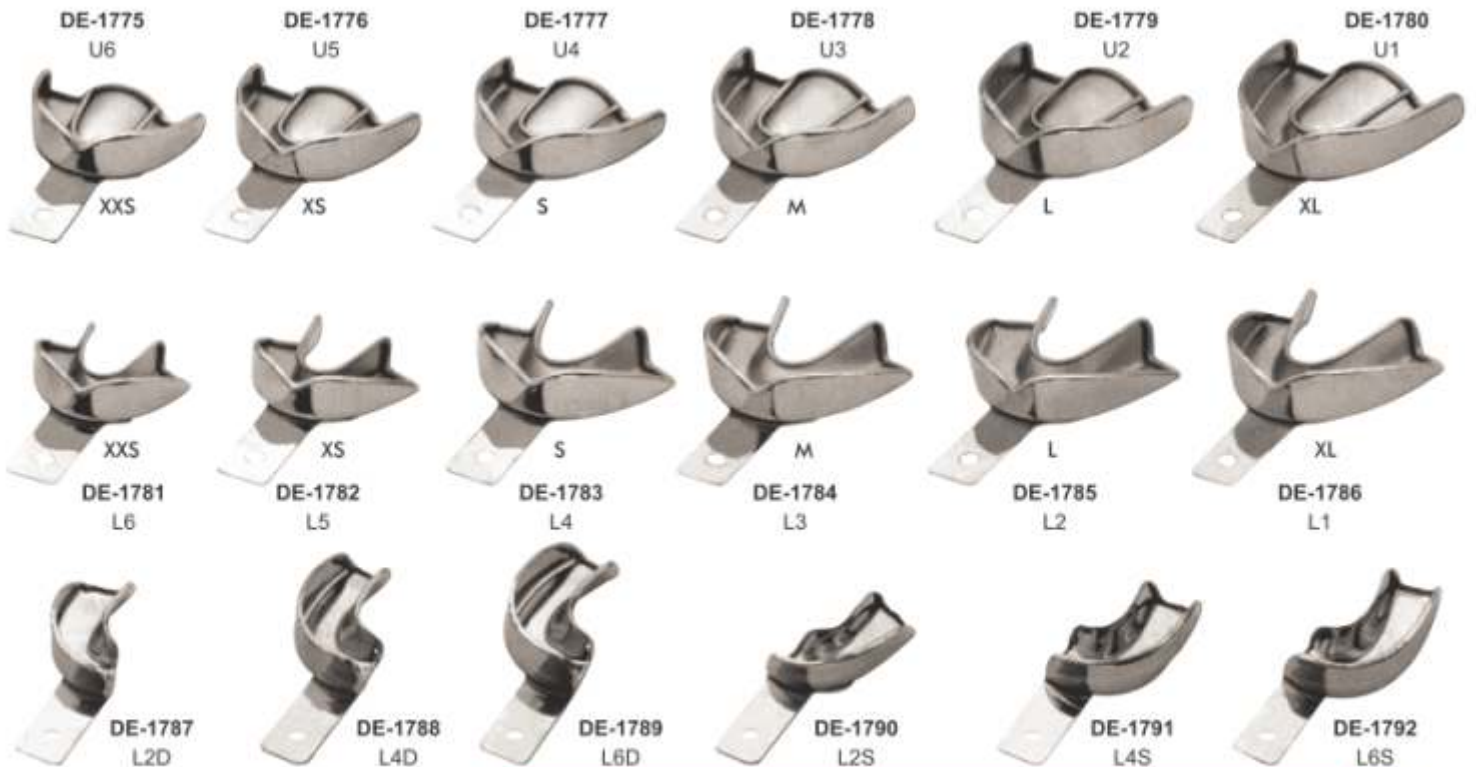

INSTRUMENTS CASSETTES & STANDS



DE-1793
Mesh Cassettes
5 Pieces, 7 Pieces, 10 Pieces,
15 Pieces & 20 Pieces

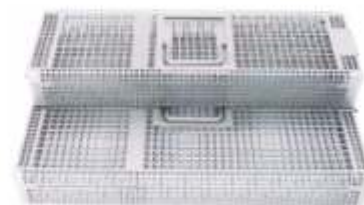

DE-1795
Instruments Cassette
7 Pieces & 10 Pieces



DE-1796
Gracey Curette Set Cassettes



DE-1797
182 x 150 x 20 mm
10 Instruments



DE-1798
180 x 85 x 15 mm
5 Instruments



DE-1799
288 x 182 x 35 mm
20 Instruments



DE-1800
288 x 182 x 35 mm
20 Instruments



DE-1801
182 x 145 x 35 mm
10 Instruments



DE-1802
182 x 72 x 35 mm
5 Instruments



DE-1803
182 x 145 x 35 mm
9 Instruments



DE-1804
Gracey Curette Set Stand



DE-1805
Sinus Lift Set Stand



Made of 18/8 stainless steel



KIDNEY TRAY WITH COVER
(English Pattern)

DE-1806	Size
DE-1807	150 mm
DE-1808	200 mm
DE-1809	240 mm
	300 mm



Kidney Trays

With lid available		Without lid available	
DE-1810	6"	DE-1814	6"
DE-1811	8"	DE-1815	8"
DE-1812	10"	DE-1816	10"
DE-1813	12"	DE-1817	12"



Deep	DE-1818	2.25" - 2"
	DE-1819	4.75" - 2"
	DE-1820	5.5" - 2.5"
	DE-1821	6.25" - 2.75"
	DE-1822	7" - 3.5"



Sterilizing Drum

Art #	Ø mm	h mm
DE-1823	80	80
DE-1824	120	120
DE-1825	160	120
DE-1826	190	140
DE-1827	190	200
DE-1828	240	120
DE-1829	240	160
DE-1830	240	240
DE-1831	290	120
DE-1832	290	160
DE-1833	290	240
DE-1834	340	160
DE-1835	340	240
DE-1836	390	145
DE-1837	390	200
DE-1838	390	290



Bowl
DE-1839 Fig. 1 to 14



DE-1840
Endodontic Box



DE-1841 6" x 8"
DE-1842 8" x 10"
DE-1843 10" x 12"
Without Lid



DE-1844
Instruments Box



SCALER TRAY
DE-1845
100 x 200 mm



Sterilizing Cases Stainless Steel



- DE-1846 130X50X50 mm
- DE-1847 130X60X50 mm
- DE-1848 140X80X50 mm
- DE-1849 150X60X50 mm
- DE-1850 160X30X25 mm
- DE-1851 170X70X30 mm
- DE-1852 180X80X40 mm
- DE-1853 180X90X40 mm
- DE-1854 200X100X40 mm

- DE-1855 220X120X50 mm
- DE-1856 230X130X50 mm
- DE-1857 230X150X50 mm
- DE-1858 250X100X50 mm
- DE-1859 300X150X50 mm
- DE-1860 300X200X50 mm
- DE-1861 350X160X60 mm
- DE-1862 400X200X90 mm
- DE-1863 500X200X125 mm

- DE-1864 130X50X50 mm
- DE-1865 130X60X50 mm
- DE-1866 140X80X50 mm
- DE-1867 150X60X50 mm
- DE-1868 160X30X25 mm
- DE-1869 170X70X30 mm
- DE-1870 180X80X40 mm
- DE-1871 180X90X40 mm
- DE-1872 200X100X40 mm

- DE-1873 220X120X50 mm
- DE-1874 230X130X50 mm
- DE-1875 230X150X50 mm
- DE-1876 250X100X50 mm
- DE-1877 300X150X50 mm
- DE-1878 300X200X50 mm
- DE-1879 350X160X60 mm
- DE-1880 400X200X90 mm
- DE-1881 500X200X125 mm



INSTRUMENTS BOX

- DE-1882 130/50/50 mm
- DE-1883 130/60/50 mm
- DE-1884 140/80/50 mm
- DE-1885 150/60/50 mm
- DE-1886 160/30/25 mm
- DE-1887 170/70/30 mm
- DE-1888 180/80/40 mm
- DE-1889 180/90/40 mm
- DE-1890 200/100/40 mm
- DE-1891 220/120/50 mm

- DE-1892 230/130/50 mm
- DE-1893 230/150/50 mm
- DE-1894 250/150/50 mm
- DE-1895 300/150/50 mm
- DE-1896 300/200/50 mm
- DE-1897 350/160/60 mm
- DE-1898 350/160/60 mm
- DE-1899 400/200/90 mm
- DE-1900 500/200/125mm



NEEDLES BOX

- DE-1901 150/60/20 mm
- DE-1902 140/80/20 mm
- DE-1903 220/120/20 mm



FORCEPS JAR

DE-1904 Fig. 1 to 5

Ø	h
mm	mm
52	100
52	130
52	175
70	130
	175
	200
	200



Forceps Jars

DE-1905 Fig. 3/3

Ø	h
mm	mm
25	130



Forceps Jar

- DE-1906 25 x 80mm
- DE-1907 30 x 100mm
- DE-1908 100 x 200mm
- DE-1909 75 x 173mm



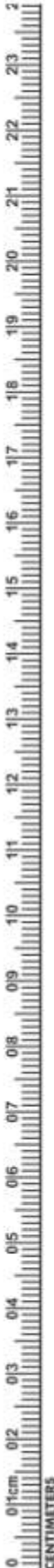

Mm Hmm
55 70

Cotton Holders
DE-1910 Fig. 000/1



Cotton Holder -
DE-1911



DE-1912
Sprit Lamp
Single Nut



DE-1913
Sprit Lamp



DE-1914
Endodontic Box
Small & Large



DE-1915
Needle Case Round with Cover



DE-1916
Bedpan Perfection Type
Small & Large



DE-1917
Urinal Female, Urinal Male, Urinal Male Vertical

IMPLANTOLOGY

- Инструменты для имплантологии
- Implantologie
- Implantologie
- Інструменти для імплантології
- Implantologia
- زراعة الأسنان



DE-1918
Endo Finger Ruler
Span Measure Scale



DE-1919
Endo Finger Ruler
Span Measure Scale



DE-1920
Endo Finger Ruler
Span Measure Scale



DE-1921
Amalgam Gun



DE-1922
Brush Stainless Steel



DE-1923
Suction Cannula Kit
with 3 Needles



DE-1924
Suction Pipe



DE-1925
Suction Needle
1mm



DE-1926
Suction Needle
1.5mm



DE-1927
Suction Needle
2mm





**Witzel
DE-1851**
170mm

Upper roots, Universal



**Witzel
DE-1852**
165mm

Lower roots, Universal



DE-1853
#400(300)
165mm

Upper roots, Universal



DE-1854
#401(301)
160mm

Lower roots, Universal



DE-1855
Witzel Forceps With Gold
Set of 3 Pcs



DE-1856
Witzel Forceps With Hole And Screw Pattern
Set of 3 Pcs



DE-1857
Witzel Forceps With Anatomical Handle
Set of 3 Pcs



DE-1858
#401(301)
160mm

Lower roots, Universal



DE-1859
#401(301)
160mm

Lower roots, Universal



DE-1860
#401(301)
160mm

Lower roots, Universal



DE-1861
#400(300)
165mm

Upper roots, Universal



DE-1862
#400(300)
165mm

Upper roots, Universal



DE-1863
#400(300)
165mm

Upper roots, Universal



**Witzel
DE-1864**
165mm

Lower roots, Universal



**Witzel
DE-1865**
165mm

Lower roots, Universal



**Witzel
DE-1866**
165mm

Lower roots, Universal

ROOTS SPLINTER FORCEPS

- Щипцы для удаления корневых осколков
- Pincers Fragments
- Wurzelsplitterzangen

- Щипці для видалення корневих осколків
- Pinzas Para Fragmentos
- جنور متشقة الملقط



DE-1867
Splinter Forceps
15.5cm



Stieglitz Root Splinter Forceps



DE-1868
Splinter Forceps
15.5cm 45°



DE-1869
Stieglitz
Root Fragments



DE-1870
Stieglitz
Root Fragments



DE-1871
Stieglitz Splinter Forceps
140mm 90°



DE-1872
Stieglitz Splinter Forceps
140mm Straight





With Diamond

DE-1873
130mm



With Diamond

DE-1874
130mm



With Diamond

DE-1875
125mm



DE-1876
130mm



DE-1877
130mm



DE-1878
125mm

EXTRACTING FORCEPS (English Pattern)

- Щипцы экстракционные (английская форма)
- Daviers (Forme Anglaise)
- Zahnzangen (Englische Form)
- Щипці екстракційні (англійська форма)
- Forceps de Extracción (Forme Inglesa)
- استخراج الملقط (نمط اللغة الإنجليزية)

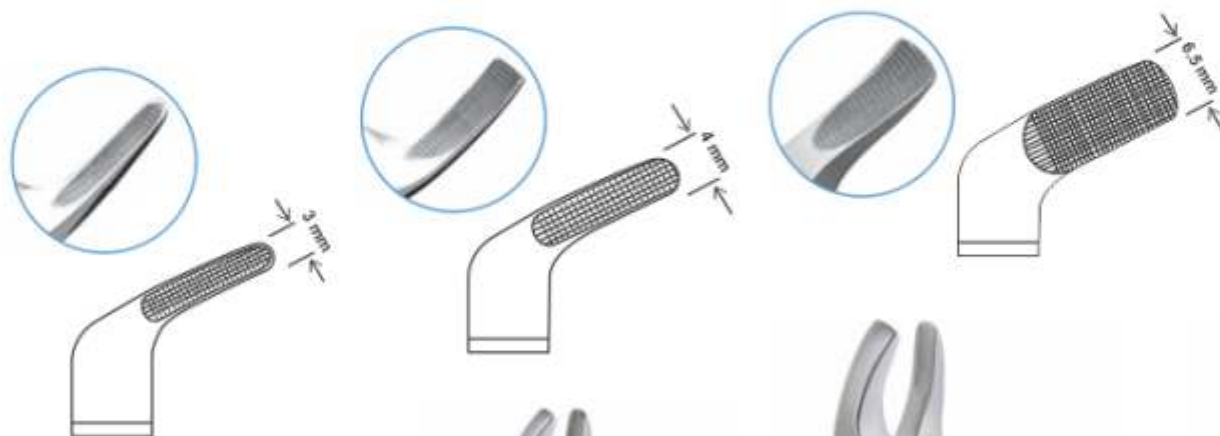

DE-1879
Meissner
Extracting Forceps



DE-1880
Meissner
Extracting Forceps



DE-1881
Meissner
Extracting Forceps



DE-1882
Comellas Forceps
Anatomical Handle



EXTRACTING FORCEPS SET

- Извлечение щипцов
- Ensemble de pinces d'extraction
- Zange sammeln
- Витягуючий комплект щипців
- Extracción del conjunto de fórceps
- استخراج منقذ مجموعة



DE-1938
Extracting Forceps
Set of 10 Pieces
Extracting Forceps Fig. 2
Extracting Forceps Fig. 7
Extracting Forceps Fig. 13
Extracting Forceps Fig. 17
Extracting Forceps Fig. 18
Extracting Forceps Fig. 22
Extracting Forceps Fig. 33
Extracting Forceps Fig. 51A
Extracting Forceps Fig. 67A
Extracting Forceps Fig. 79



DE-1939
Extracting Forceps
Set of 10 Pieces
Extracting Forceps Fig. 2
Extracting Forceps Fig. 7
Extracting Forceps Fig. 13
Extracting Forceps Fig. 17
Extracting Forceps Fig. 18
Extracting Forceps Fig. 22
Extracting Forceps Fig. 33
Extracting Forceps Fig. 51A
Extracting Forceps Fig. 67A
Extracting Forceps Fig. 79



DE-1940
Extracting Forceps
Set of 13 Pieces
Extracting Forceps Fig. 2
Extracting Forceps Fig. 7
Extracting Forceps Fig. 13
Extracting Forceps Fig. 17
Extracting Forceps Fig. 18
Extracting Forceps Fig. 22
Extracting Forceps Fig. 33
Extracting Forceps Fig. 51A
Extracting Forceps Fig. 67A
Extracting Forceps Fig. 79
Extracting Forceps Fig. 86C
Extracting Forceps Fig. 89
Extracting Forceps Fig. 90



DE-1941
Extracting Forceps Children Pattern
Set of 10 Pieces
Extracting Forceps Fig. 13S
Extracting Forceps Fig. 22S
Extracting Forceps Fig. 30S
Extracting Forceps Fig. 33S
Extracting Forceps Fig. 37
Extracting Forceps Fig. 38
Extracting Forceps Fig. 39
Extracting Forceps Fig. 39L
Extracting Forceps Fig. 39R
Extracting Forceps Fig. 51S



DE-1942
Extracting Forceps English adult Adult
Set of 10 Pcs



DE-1943
Extracting Forceps American Adult
Set of 10 Pcs



DE-1944
Extracting Forceps American Adult
Set of 8 Pcs



DE-1945
Extracting Forceps Pedro
Set of 7 Pcs



ROOT ELEVATOR

- Elevator корневой экстракционный
- Elévateurs à racines
- Wurzelheber
- Elevator корневий екстракційний
- Elevadores para raíces
- المعصاع الجذر



DE-1946
Fig. 1
Chompret



DE-1947
Fig. 2
Chompret



DE-1948
Fig. 3
Chompret



DE-1949
Fig. 4
Chompret



Lecluse elevator for lower third molar dislocation



Chompret syndesmotome, sickle pattern

Root Pick Elevator With Gold Flexible Points



DE-1950



DE-1951



DE-1952



DE-1953



DE-1954



DE-1955



DE-1956



ROOT ELEVATOR

- Элеватор корневой экстракционный
- Élévateurs à racines
- Wurzelheber

- Elevator cornevil ekstrakçionnyy
- Elevadores para raices
- المصاعد الجذر

FUNCTION: To loosen small root fragments from bony socket



Heidbrink Roots Elevator

Warwick-James



ROOT ELEVATOR

- Элеватор корневой экстракционный
- Elévateurs à racines
- Wurzelheber
- Слеватор корневий экстракційний
- Elevadores para raices
- المعاصر الجذر



DE-1966
Luxators Set of 7 Pcs



DE-1967
Luxators Set of 7 Pcs



DE-1968
Luxators Set of 8 Pcs



DE-1969
Root Elevators Set of 10 Pcs



DE-1970
Elevators Set of 8 Pcs



DE-1971
Elevators Set of 8 Pcs



HANDLES FOR MOUTH MIRRORS

- Ручки для зеркал
- Manches pour miroirs à bouche
- Mundspiegelgriffe

- Ручки для дзеркал
- Mangos para espejos de boca
- مقابض لمرآة الفم



DE-1972
Hollow Mirror
Handle Round
Ø 10 mm



DE-1973
Hollow Mirror
Hexagonal
Handle
Ø 8 mm



DE-1974
Hollow
Ø 8 mm



DE-1975
Hollow Mirror
Hexagonal
Handle
Ø 10 mm



DE-1976
Hollow Mirror
Handle
Ø 8 mm



DE-1977
Hollow Mirror
Handle
Ø 10 mm

Cone-Socket Mirror Handle



DE-1978
Mirror Handle
Solid
Ø 6 mm



DE-1979
Mirror Handle
Solid
Ø 6 mm



DE-1980
Mirror Handle
Solid Octagonal
Ø 6 mm



DE-1981
Mirror Handle
Stem
with Rule
35mm



DE-1982
Mirror Handle
Solid
Stem with
Rule 35mm



DE-1983
Cone-Socket
Solid Octagonal
Ø 6 mm



DE-1984
Cone-Socket
Solid
Ø 6 mm



DE-1985
Cone-Socket
Hexagonal
Handle
Ø 6 mm

EXPLORERS

- Зонды
- Sondes
- Zahnsonden
- Зонди
- Sondas
- المستكشفين

Examination kit Set of 3 Pieces



DE-1986 Probe
DE-1987 Mirror
DE-1988 College Forcep 15cm



Examination Set of 4 Pieces



DE-1989 Exp,23/17-A
DE-1990 Exavators
DE-1991 Tweezers
DE-1992 Mouth Mirror

DE-1993

First Aid Examination Set of 3 Pieces



DE-1994

First Aid Examination Set of 3 Pieces



DE-1995

First Aid Examination Set of 3 Pieces



DE-1996

First Aid Examination Set of 3 Pieces



23
22
21
20
19
18
17
16
15
14
13
12
11
10
09
08
07
06
05
04
03
02
01
0
10
01cm
CENTIMETERS



DE-1997
Gracey Curettes 1/2



DE-1998
Gracey Curettes 3/4



DE-1999
Gracey Curettes 5/6



DE-2000
Gracey Curettes 7/8



DE-2001
Gracey Curettes 9/10



DE-2002
Gracey Curettes 11/12



DE-2003
Gracey Curettes 13/14



DE-2004
Gracey Curettes 1/2



DE-2005
Gracey Curettes 3/4



DE-2006
Gracey Curettes 5/6



DE-2007
Gracey Curettes 7/8



DE-2008
Gracey Curettes 9/10



DE-2009
Gracey Curettes 11/12



DE-2010
Gracey Curettes 13/14



SCALER

GRACEY MINI FIVE

Hollow Handle 9.5mm, Length 170mm Ceramic Coated Handle



DE-2012
Fig. 3/4 Gracey 3M



DE-2013
Fig. 5/6 Gracey 3M



DE-2014
Fig. 7/8 Gracey 3M
Buccal and lingual/
Palatal surfaces

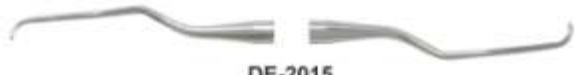

DE-2015
Fig. 11/12 Gracey 3M
Mesial



DE-2016
Fig. 13/14 Gracey 3M
Distal

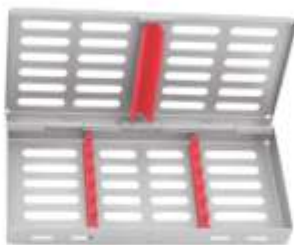

DE-2011
Fig. 1/2
Gracey 3M

GRACEY AFTER FIVE

Hollow Handle 9.5mm, Length 170mm Ceramic Coated Handle



DE-2018
Gracey 3/4 AF



DE-2019
Gracey 5/6 AF



DE-2020
Gracey 7/8 AF

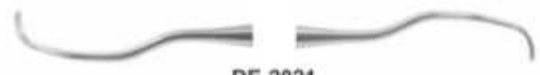

DE-2021
Gracey 11/12 AF



DE-2022
Gracey 13/14 AF



DE-2017
Gracey
1/2 AF



SCALER

Gracey Curettes



$\frac{3...1}{3...1} \mid \frac{1...3}{1...3}$ **DE-2023 Fig. 1/2 GR - Gracey**
Buccal surfaces



$\frac{5...1}{5...1} \mid \frac{1...5}{1...5}$ **DE-2024 Fig. 3/4 GR - Gracey**
Lingual/Palatal surfaces



$\frac{5...1}{5...1} \mid \frac{1...5}{1...5}$ **DE-2025 Fig. 5/6 GR - Gracey**



$\frac{8...4}{8...4} \mid \frac{4...8}{4...8}$ **DE-2026 Fig. 7/8 GR - Gracey**
Buccal and lingual/
palatal surfaces



$\frac{8...4}{8...4} \mid \frac{4...8}{4...8}$ **DE-2027 Fig. 9/10 GR - Gracey**
Buccal and lingual/
palatal surfaces more angled



$\frac{8...4}{8...4} \mid \frac{4...8}{4...8}$ **DE-2028 Fig. 11/12 GR - Gracey**
Mesial



$\frac{8...4}{8...4} \mid \frac{4...8}{4...8}$ **DE-2029 Fig. 13/14 GR - Gracey**
Distal



$\frac{8...4}{8...4} \mid \frac{4...8}{4...8}$ **DE-2030 Fig. 15/16 GR - Gracey**
Mesial



$\frac{8...4}{8...4} \mid \frac{4...8}{4...8}$ **DE-2031 Fig. 17/18 GR - Gracey**
Distal



- 410-434-436
- 410-437
- 411/12-415/16
- 412/14-415/16

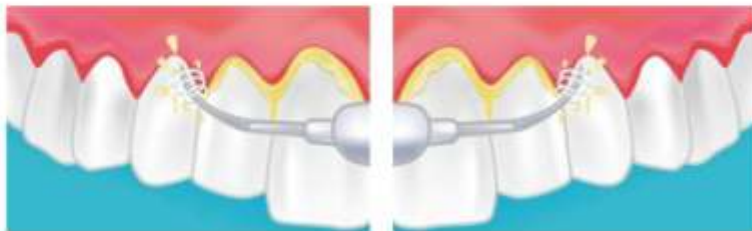

- 410-434-436
- 410-437
- 411/12-415/16
- 412/14-415/16

Sickle Scalers



DE-2032 Fig. U15/33 - Towner-Jaquette



DE-2033 Fig. U15/30 - Towner-Jaquette



DE-2034 Fig. H5/33



DE-2035 Fig. H6/H7



DE-2036 Fig. 30/33 - Jaquette



DE-2037 Fig. T2/T3 - Taylor



DE-2038 Fig. 204



DE-2039 Fig. 204S



DE-2040 Fig. 11/12 - MC - McCall
Mesial



DE-2041 Fig. 13/14 - MC - McCall
Distal



Straight and curved sickle scalers

Feature: 2 cutting edges curved facial component tipped ends



Universal curettes

are characterized by an angle of 90° between the terminal stem and the cutting component.



Gracey curettes

are characterized by an angle of 70° between the terminal stem and the cutting component.



SCALER

Universal Curettes



DE-2042 Fig. 13S/14S - MC - McCall



DE-2043 Fig. 17S/18S - MC - McCall
Distal



DE-2044 Fig. M23



DE-2045 Fig. 204SD



DE-2046 Fig. YG7/8-Younger Good



DE-2047 Fig. L 1/2 - Langer



DE-2048 Fig. L 3/4 - Langer



DE-2049 Fig. L 5/6 - Langer



DE-2050 Fig. M 23A



DE-2051 Fig. M 23B



Straight and curved sickle scalers

Feature: 2 cutting edges curved facial component tipped ends



Universal curettes

are characterized by an angle of 90° between the terminal stem and the cutting component.



Gracey curettes

are characterized by an angle of 70° between the terminal stem and the cutting component.





DE-2052
WHITE 28



DE-2053
WHITE 29



DE-2054
WHITE 31



DE-2055
WHITE 32



DE-2056
WHITE 33



DE-2057
WHITE 34



DE-2058
WESTCOTT 21



DE-2059
WESTCOTT 21B



DE-2060



DE-2061



DE-2062
WHITE



DE-2063
WHITE



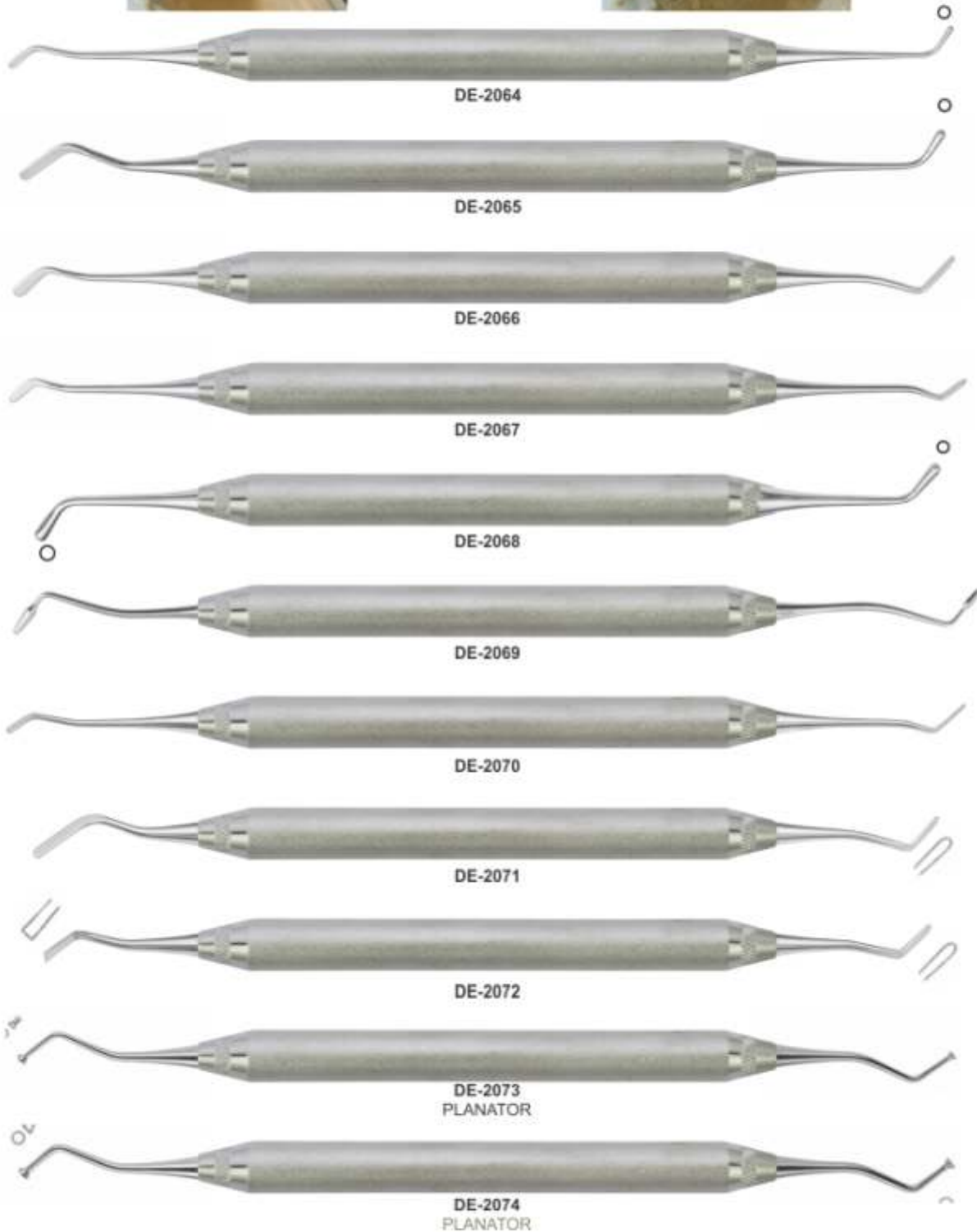

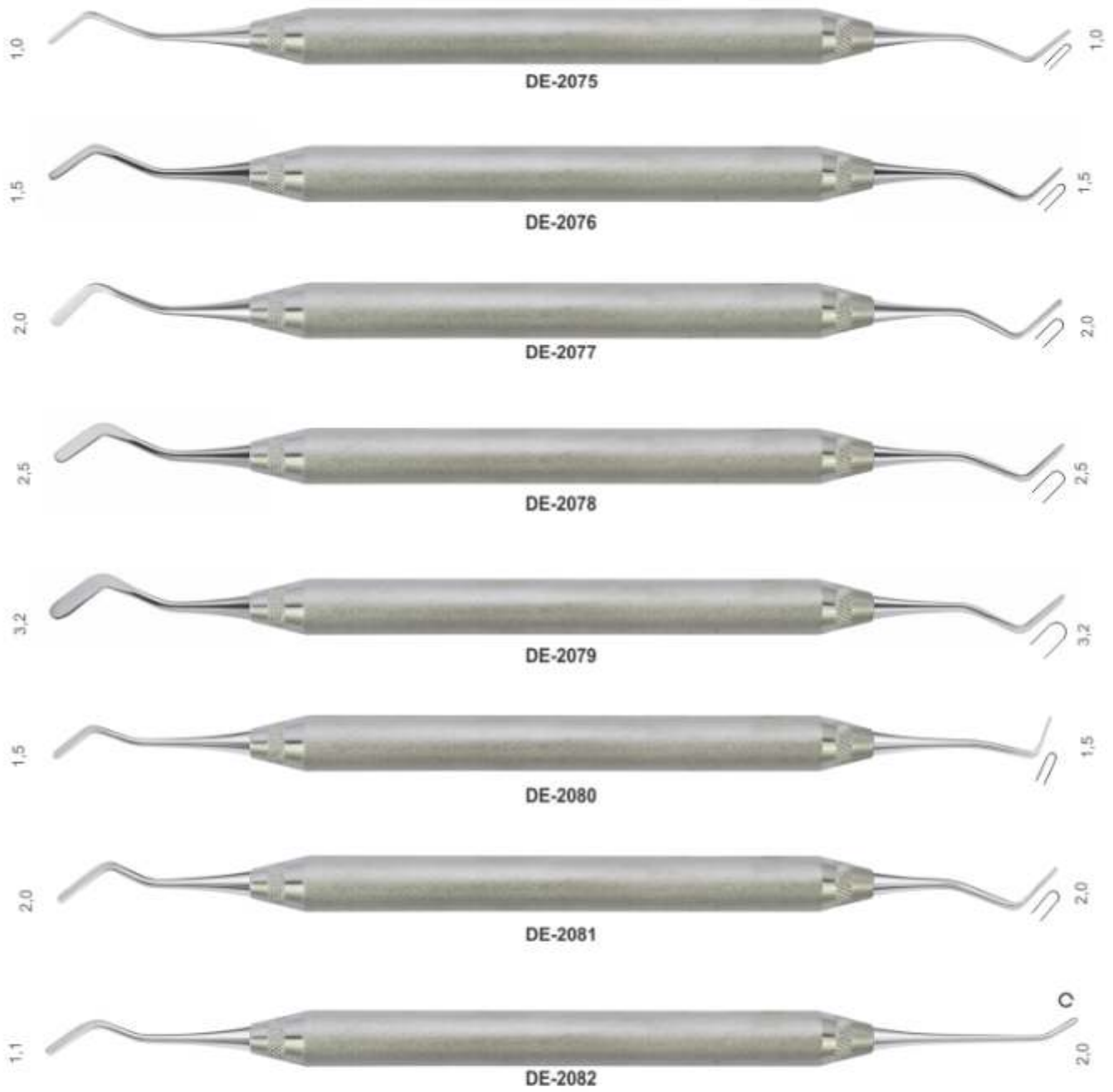

Ball Burnishers



Hatches



COMPOSITE INSTRUMENTS

Spatulas rounded and sharp

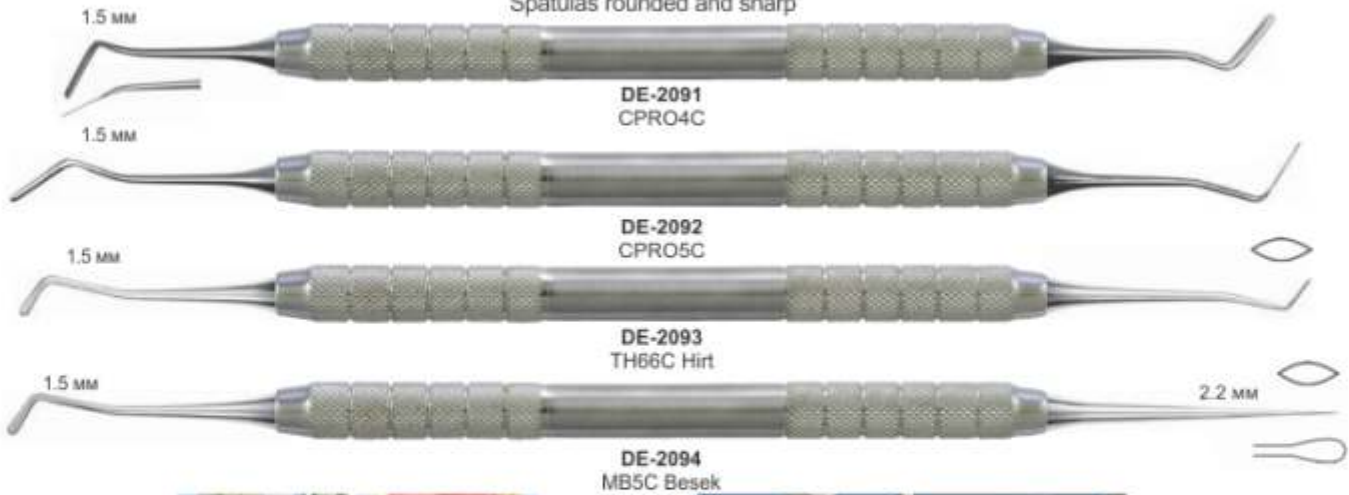

Spatulas Blade Thickness 0.22 MM

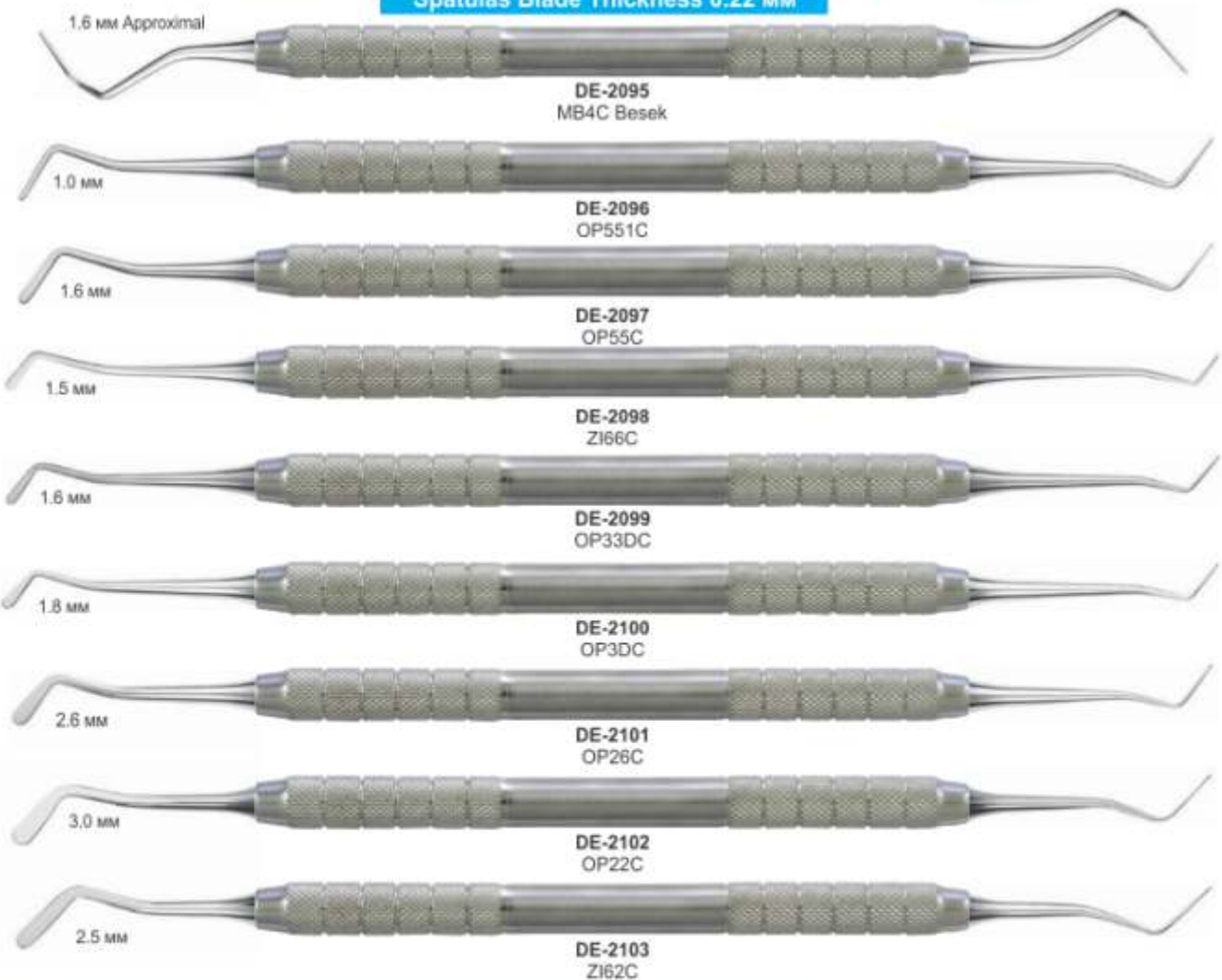



Spatulas

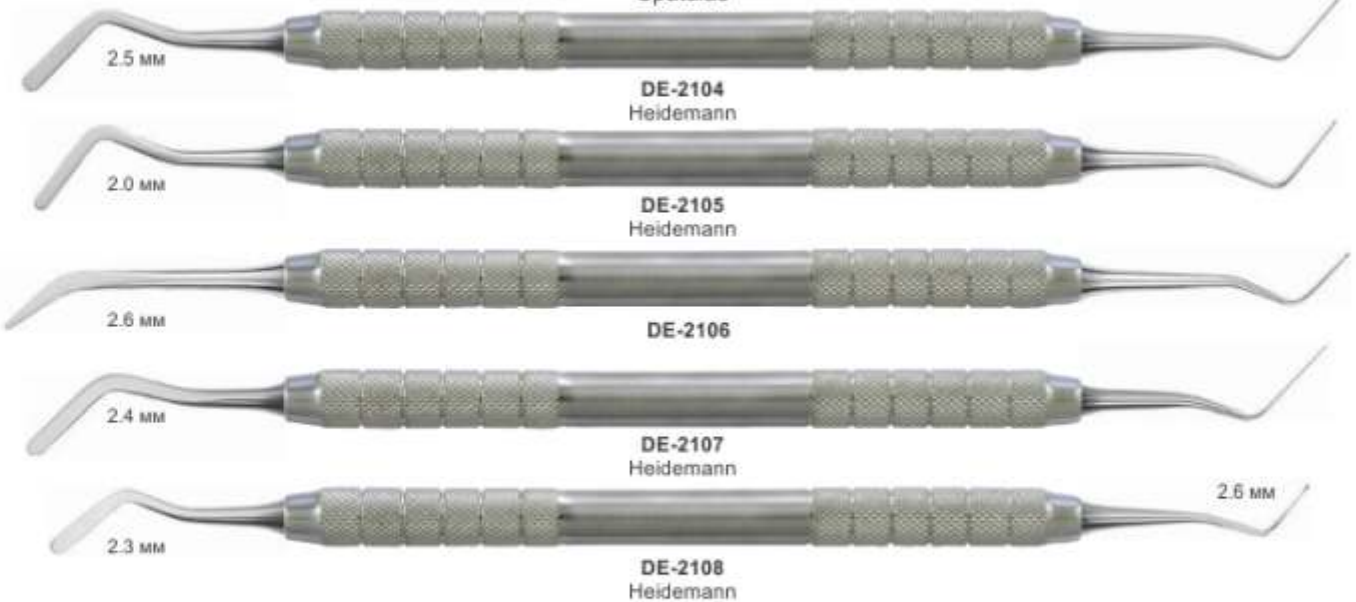

Spatulas-Pluggers



EXCAVATOR INSTRUMENTS

Water drop Our excavators have particularly sharp blades, free of burrs and perfectly rounded.

110

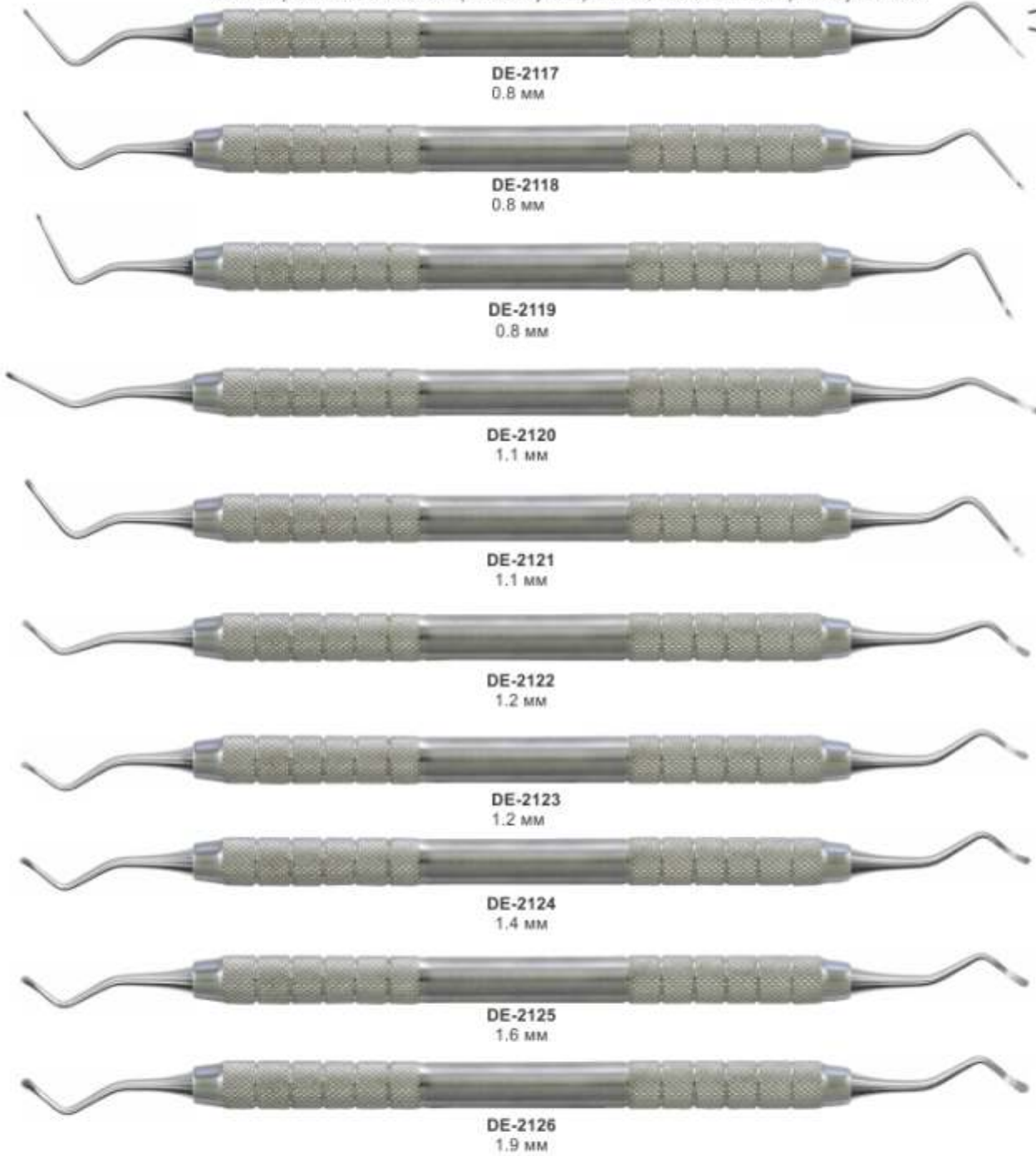

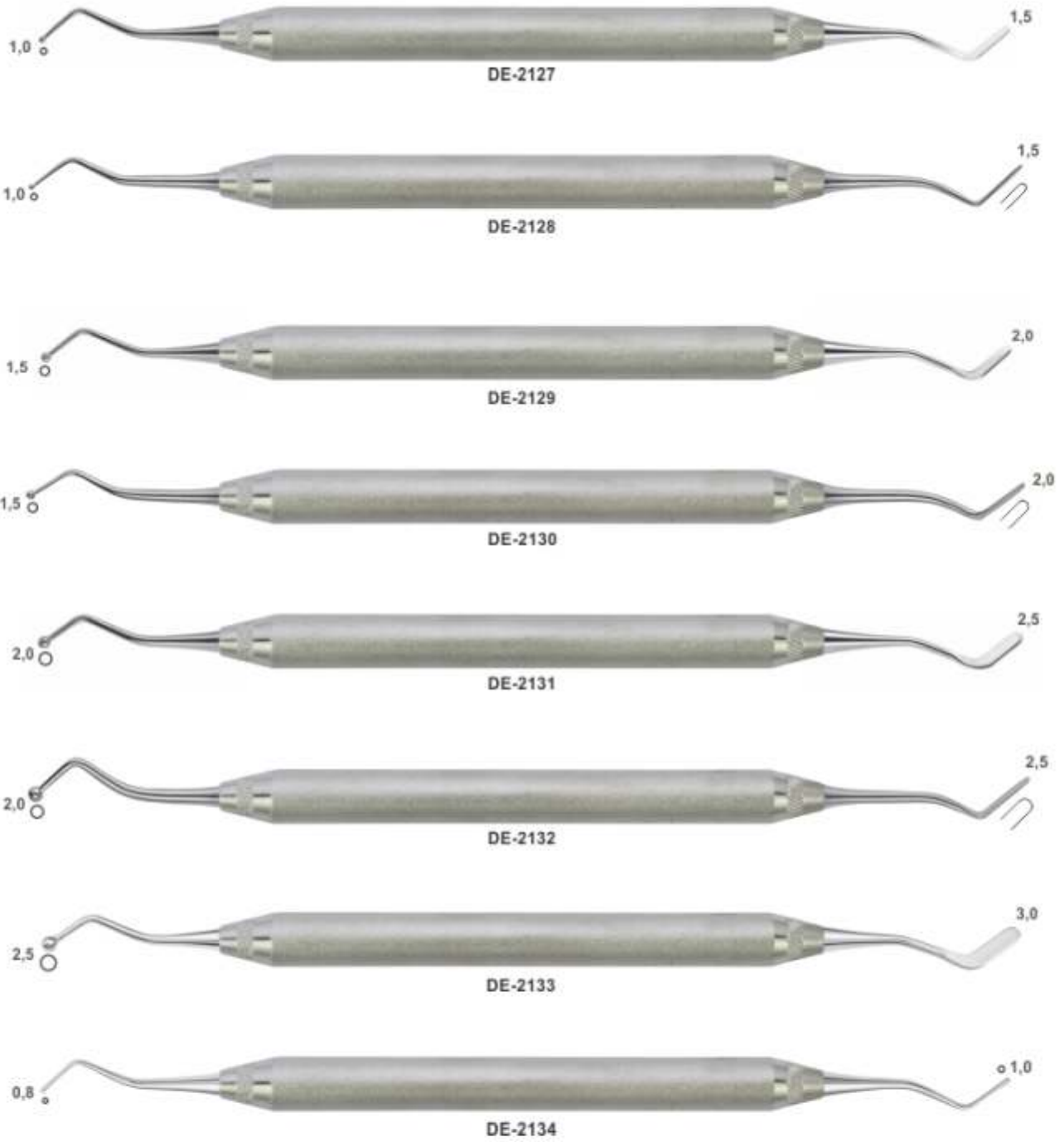

COMPOSITE BALL PLUGGERS

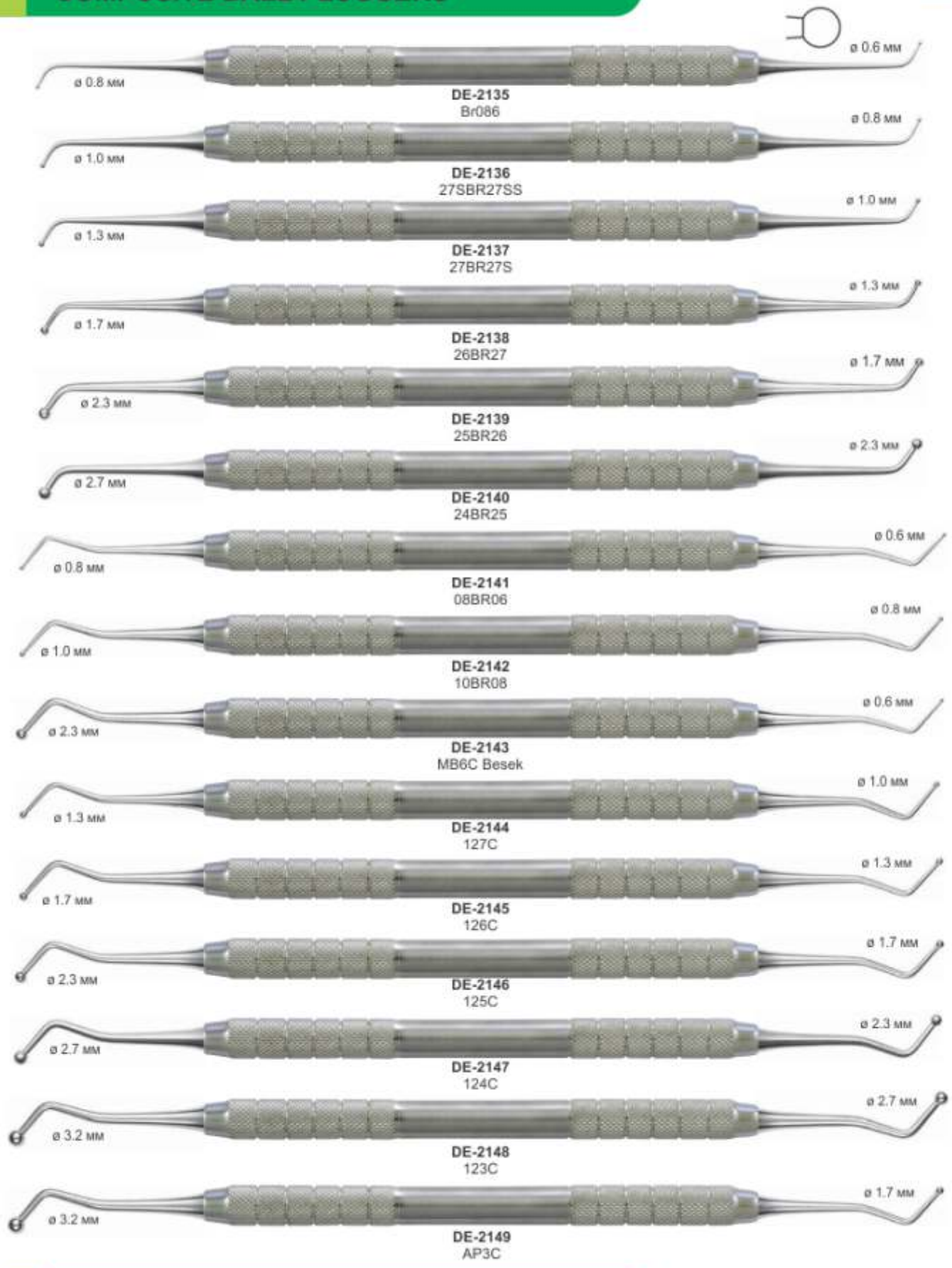

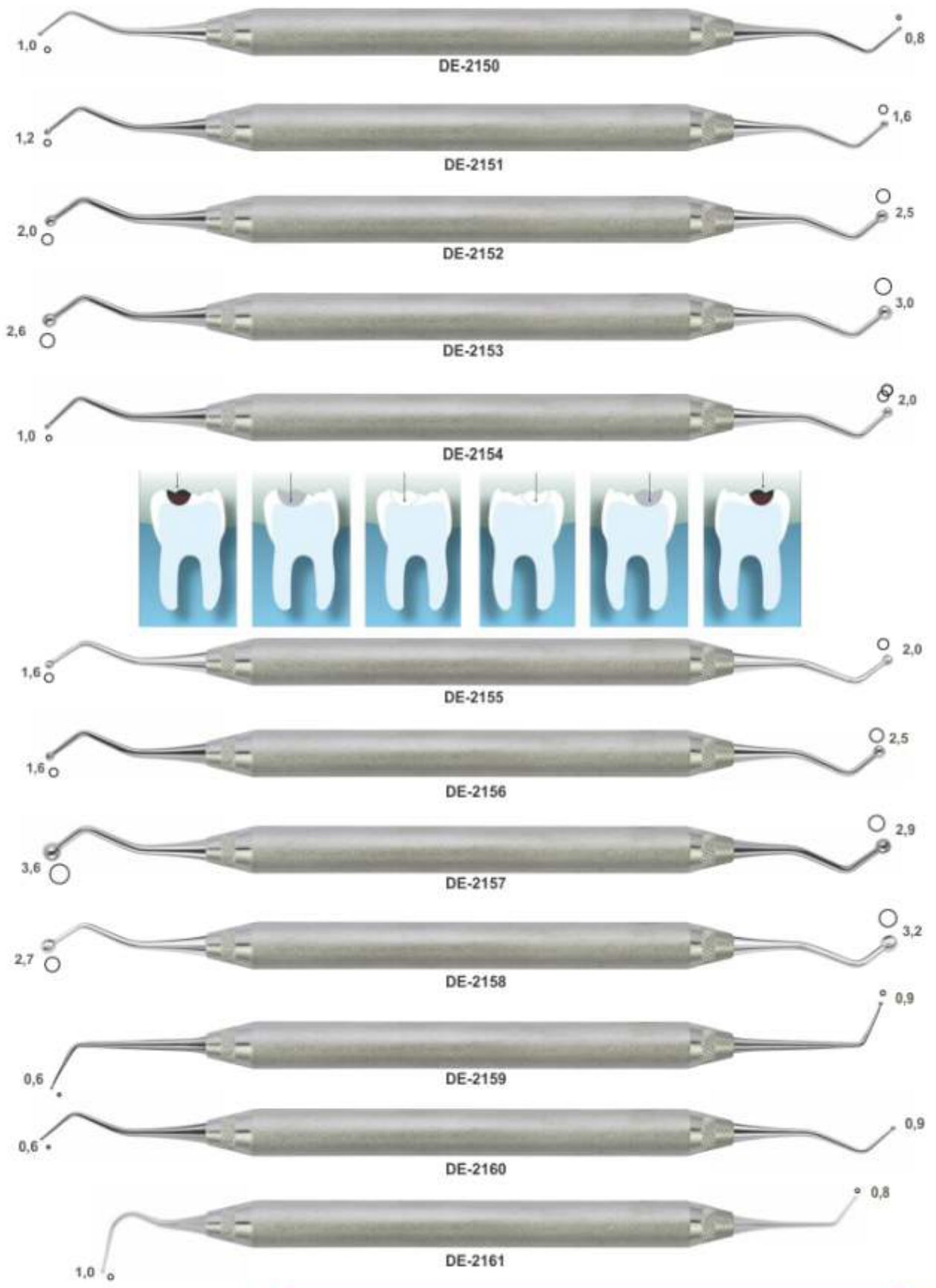

FILLING INSTRUMENTS CONSERVATIVE TREATMENT

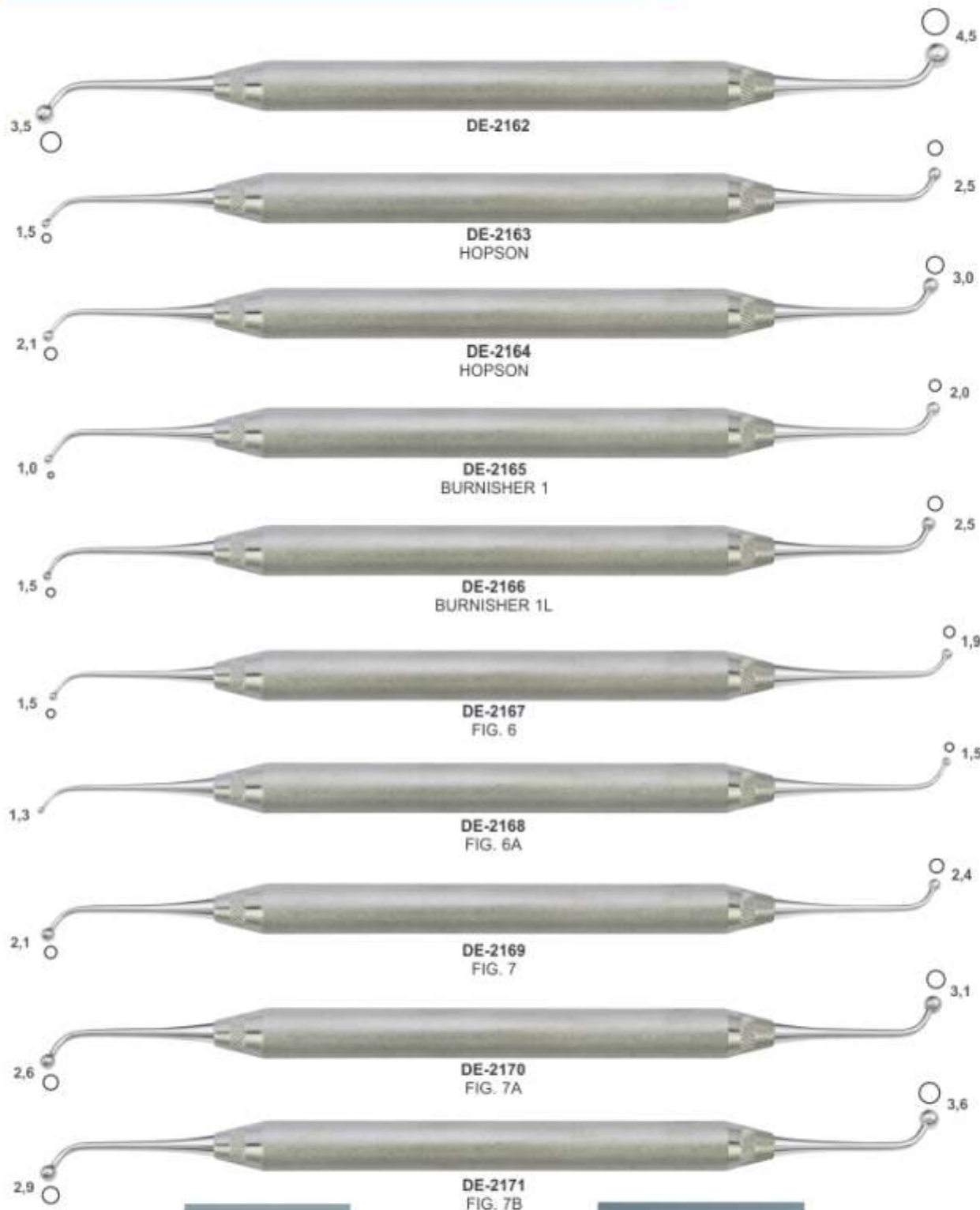

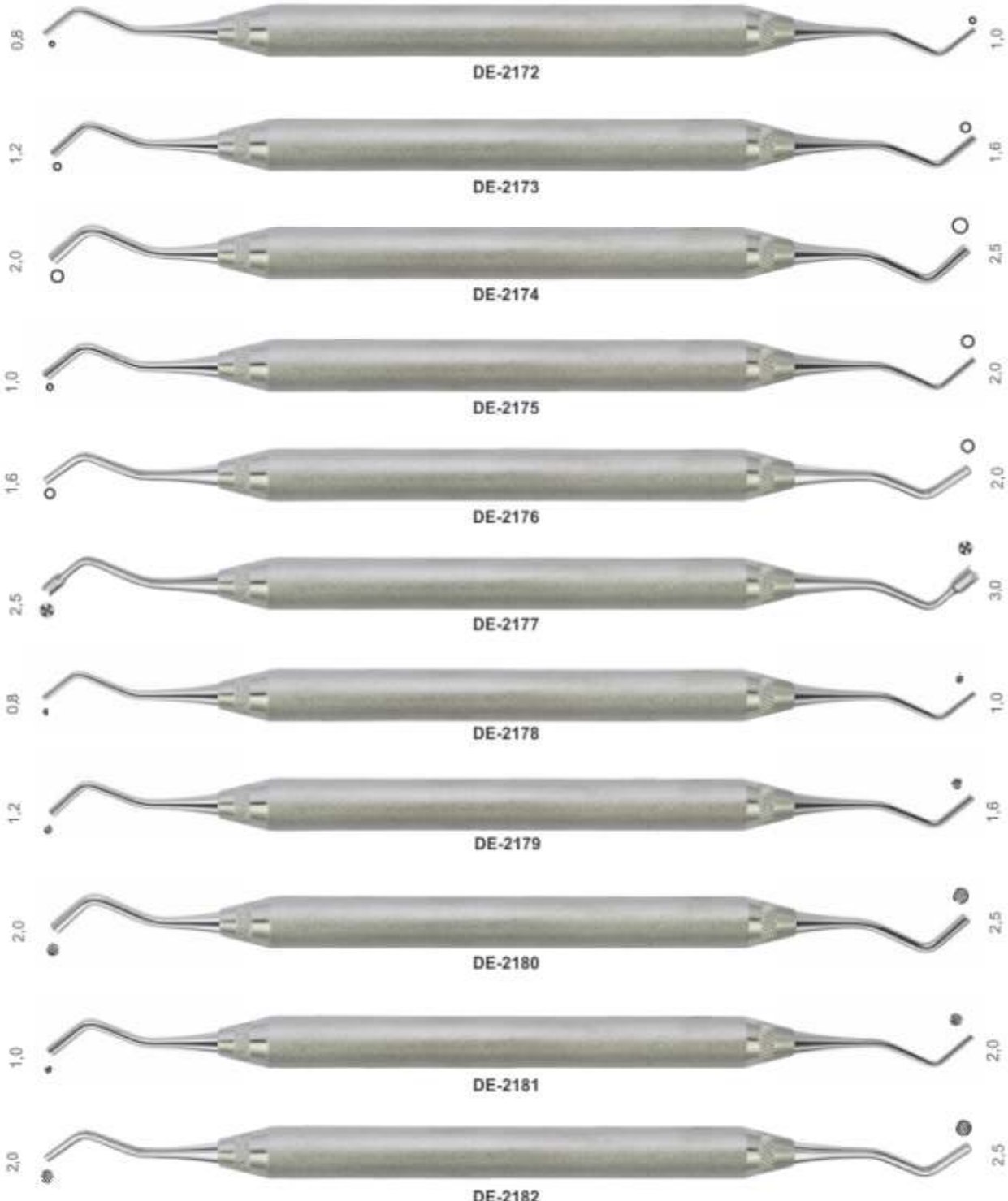

FILLING INSTRUMENTS CONSERVATIVE TREATMENT

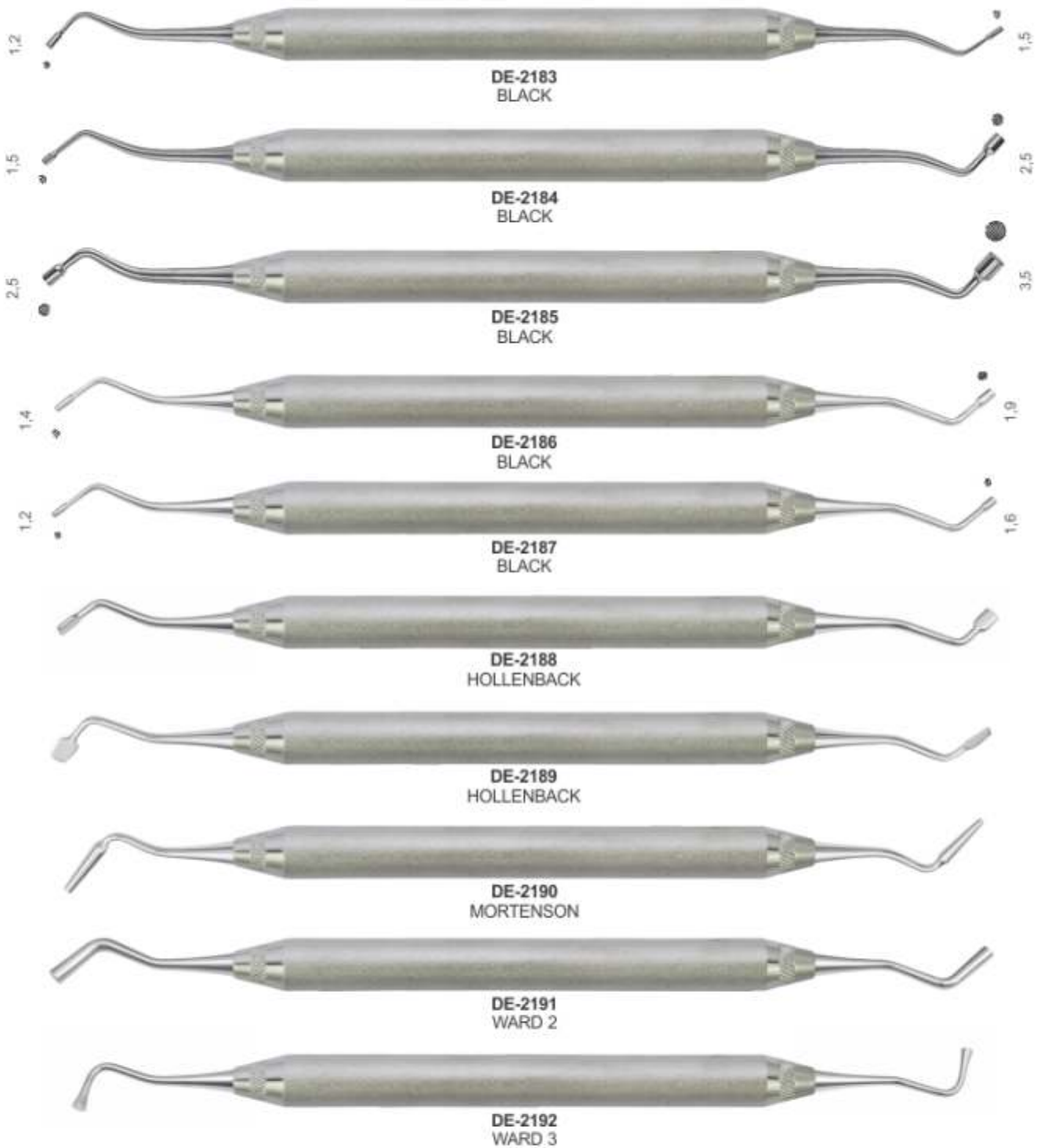

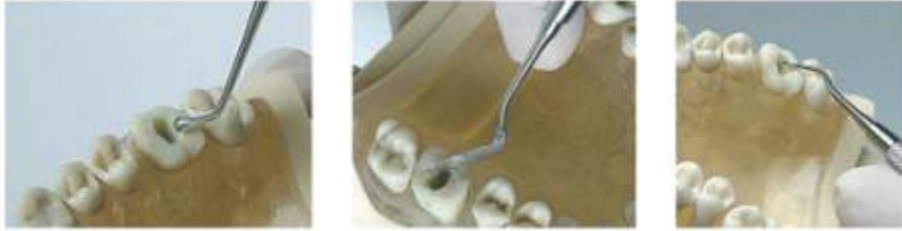

**DE-2193
WILLIAMS**



**DE-2194
WILLIAMS**



**DE-2195
WILLIAMS**



DE-2196



DE-2197



DE-2198



DE-2199



DE-2200



DE-2201



DE-2202



CARVERS INSTRUMENTS

- Инструменты для реставрации
- Instruments a modeler
- Modellierinstrumente
- Инструменти для реставрації
- Instrumentos para modelar
- أدوات تقطیع

P.K. THOMS WAXING INSTRUMENTS SOLID HANDLE 6mm

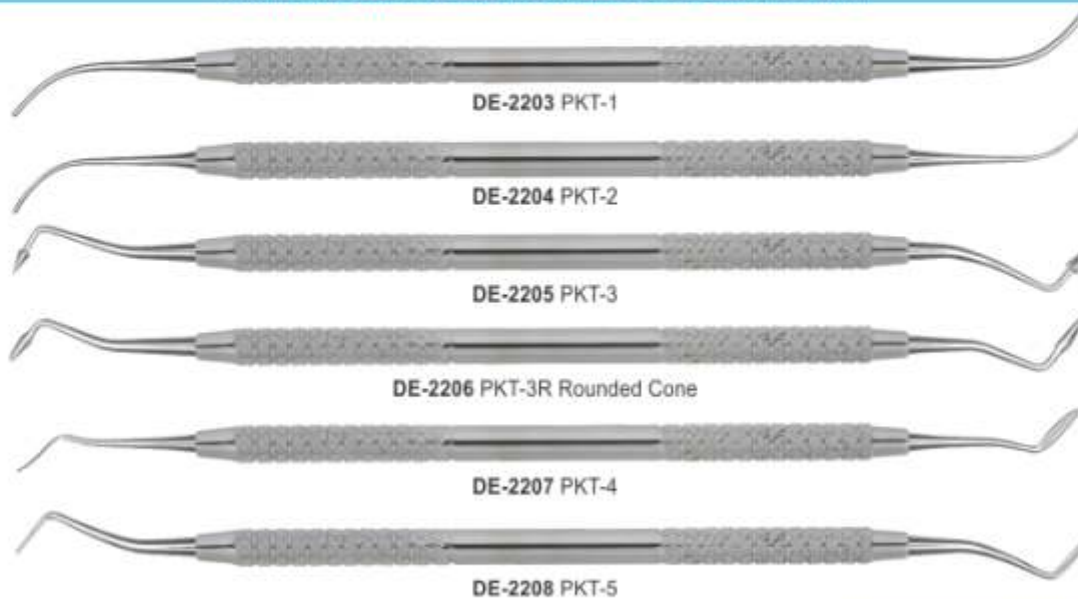

DE-2209
Composite Instruments Blue
Titanium with Cassettes



DE-2210
P.k. Thomas Waxing Instruments Kit

COMPOSITE INSTRUMENTS TITANIUM BLUE ENDODONTIC

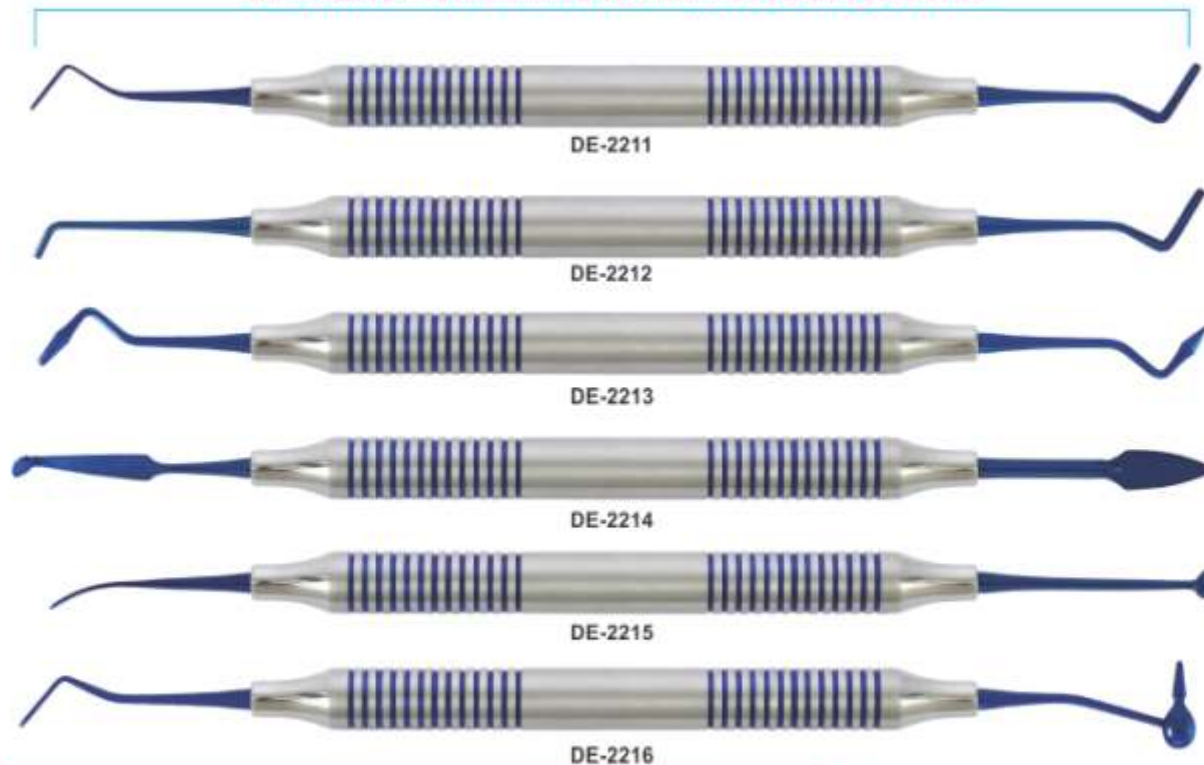

- Прочие товары
- Divers produits et services
- Sonstige Produkte

- Інші товари
- Varios Productos
- المنتجات المتنوعة

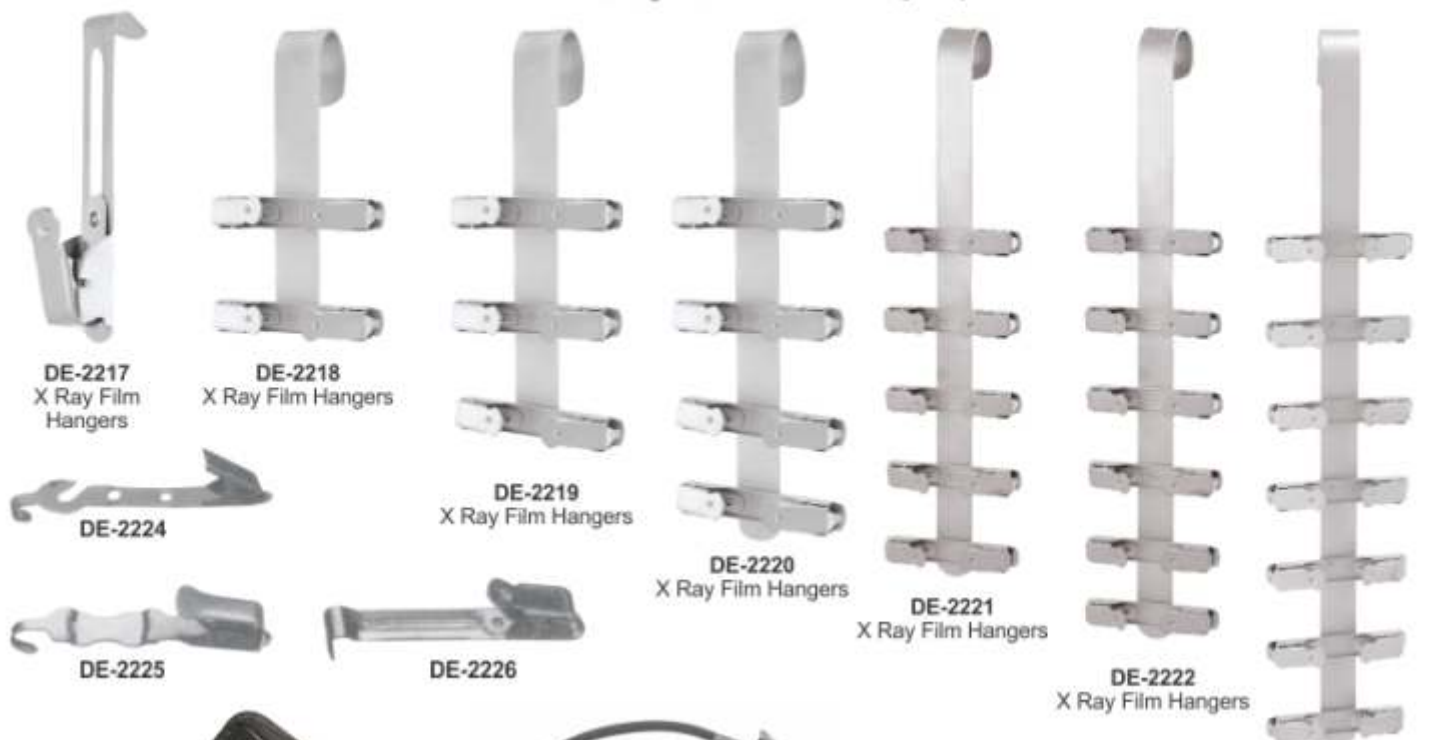
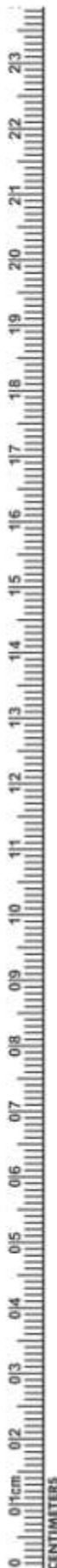

DE-2217
X Ray Film Hangers

DE-2218
X Ray Film Hangers

DE-2219
X Ray Film Hangers

DE-2220
X Ray Film Hangers

DE-2221
X Ray Film Hangers

DE-2222
X Ray Film Hangers

DE-2223
X Ray Film Hangers



DE-2224



DE-2225



DE-2226



Dissecting Set
DE-2227 Set of 9 Pcs.
DE-2228 Set of 11 Pcs.



DE-2229
Napkin Holder with Plastic Chain

DE-2230
Napkin holder with metal chain



Mouth Props
DE-2231
Small

Mouth Props
DE-2232
Medium

Mouth Props
DE-2233
Large

Key Rings



DE-2234

DE-2235

DE-2236

DE-2237

DE-2238

DE-2239

DENTAL PHOTOGRAPHIC MIRRORS



DE-2240 Adult Palatal /
DE-2241 Child Palatal



DE-2242
Buccal



DE-2243 Adult Palatal /
DE-2244 Child Palatal



DE-2245 Adult Palatal /
DE-2246 Adult Buccal



DE-2247 Lingual upper /
DE-2248 Lingual Lower



DE-2249 Adult Buccal /
DE-2250 Child Buccal



DE-2251 Child Palatal /
DE-2252 Child Buccal



DE-2253
Palatal-Adult



DE-2254
Palatal-Adult Large



DE-2255
Palatal-Child



DE-2256
Buccal-Small



DE-2257
Buccal



DE-2258
Lingual



DE-2259
Lingual-Large



NEEDLE HOLDERS

- Иглодержатели
- Porte-aiguilles
- Nadelhalter

- Голкотримачи
- Porta-agujas
- اصحاب ابرة



DE-2260
Lichtenberg-Ryder T.C
14 cm

DE-2262
Lichtenberg-Ryder T.C
17 cm

DE-2261
Lichtenberg-Ryder T.C
14 cm

DE-2263
Lichtenberg-Ryder T.C
17 cm



DE-2264
Barraquer
18 cm

DE-2266
Barraquer T.C
18 cm

DE-2265
Barraquer
18 cm

DE-2267
Barraquer T.C
18 cm



DE-2268
Tönnis
18 cm



DE-2269
Castroviejo
13 cm
Straight



DE-2270
Kalt Needle Holders T.C
14 cm Straight



DE-2271
Peet Splinter Forceps
11.5 cm

DE-2272
La Grange
Curved



DE-2273
All-Purpose Pliers

RUBBER DAM CLAMPS KITS

- Резиновая дамба зажимы комплекты
- Trousses de caoutchouc
- Gummidammklammern
- Гумова дамба затискачі комплекти
- Conjuntos de abrazaderas de retención de caucho
- المطاط الدم المشابك مجموعات



DE-2274

Stainless Steel Gold Plated Rubber Dam Clamp Tray with 11 Different Clamps
Fig. 212, 211, 8, 8A, 14, 14A, 0, 00, 2, 2A, 7



DE-2275

Stainless Steel Rubber Dam Clamp Tray with 12 Different Clamps
Fig. 209, 212, 211, 8, 8A, 14, 14A, 0, 00, 2, 2A, 7



DE-2276

Stainless Steel Rubber Dam Clamp Tray with 8 Different Clamps
Fig. 1, 26, 29, 51, 60, 202, 205, 210



DE-2277

Stainless Steel Rubber Dam Clamp Tray
(without clamps)



DE-2278

On request the Content of the rubber dam kit can be changed with other instruments.

Content:

- | | |
|------------------------------|------------------------------|
| 01 Ivory | 08 Rubber Dam Clamp Fig. 209 |
| 02 Ivory light weight | 09 Rubber Dam Clamp Fig. 212 |
| 03 Clamps Stand | 10 Rubber Dam Clamp Fig. 211 |
| 04 Rubber Dam Frame M | 11 Rubber Dam Clamp Fig. 8 |
| 05 Rubber Dam Frame L | 12 Rubber Dam Clamp Fig. 8A |
| 06 Rubber Dam Box Lower Case | 13 Rubber Dam Clamp Fig. 14 |
| 07 Rubber Dam Box Upper Case | 14 Rubber Dam Clamp Fig. 14A |
| | 15 Rubber Dam Clamp Fig. 0 |
| | 16 Rubber Dam Clamp Fig. 00 |
| | 17 Rubber Dam Clamp Fig. 2 |
| | 18 Rubber Dam Clamp Fig. 2A |
| | 19 Rubber Dam Clamp Fig. 7 |

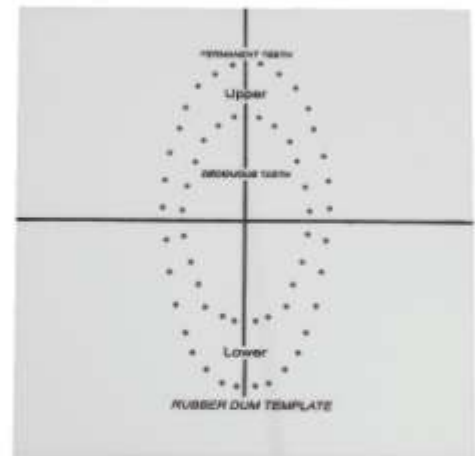

DE-2279

Rubber Dum Template



PERIODONTAL INSTRUMENTS

- Инструменты пародонтологические
 - Instruments pour la parodontologie
 - Instrumente für die Parodontologie
- Инструменти пародонтологічні
 - Instrumentos para periodoncia
 - المسكوك التثنية

To separate tissue tooth or bone. tp hold tissue away from surgical site.



PERIODONTAL INSTRUMENTS

- Инструменты пародонтологические
- Instruments pour la parodontologie
- Instrumente für die Parodontologie
- Инструменти пародонтологічні
- Instrumentos para periodoncia
- المسكوك للتانة



DE-2290



DE-2291
P24G



DE-2292
titanium Periosteal Elevator for Implan5



DE-2293
S1



DE-2294
Hirschfeld



DE-2295
9S



10mm

DE-2296
Selden

13mm

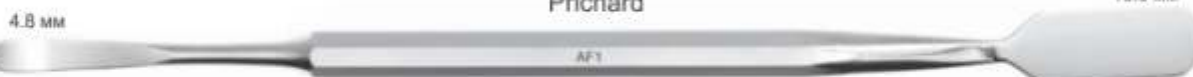

4.8 mm

Prichard

10.6 mm

DE-2297
Friedmann



DE-2298
Schmidlin

6.9 mm





DE-2299
Metal tip
220 mm
Hammer With Wooden Handle



DE-2300
Metal tip
220 mm



DE-2301
1
For plaster



DE-2302
2
For metal



DE-2303
Fret saw
250 mm



DE-2304
Small
Saw Blades



DE-2305
Large
Saw Blades



DE-2306
Ceri Saw



Special Inox
DE-2307 170mm
DE-2308 200mm



DE-2309
Plaster Shears
200 mm



Crucible Tongs
DE-2310 250 mm
DE-2311 320 mm

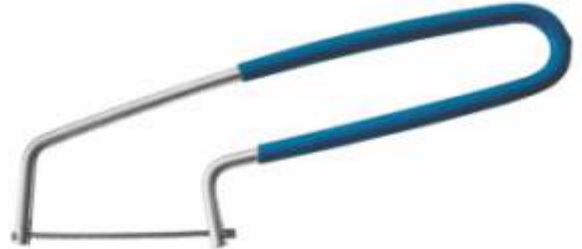

DE-2312
Ceri Saw
180 mm



DE-2313
Blade
0,12x5 mm
Conf. 12 pcs



DE-2314
Blade
0,25x5 mm
Conf. 12 pcs



DE-2315
Blade
0,25x3 mm
Conf. 12 pcs

ORTHODONTIC INSTRUMENTS

- Инструменты ортодонтические
- Instrumentos Ortodonticos
- Orthodontische Instrumente
- Инструменти ортодонтични
- Instruments Orthodontiques
- أدوات تقويم الأسنان



DE-2316
Height Gauge 0.18
Aluminum



DE-2317
Height Gauge 0.22
Aluminum



DE-2318
Height Gauge 0.18
Stainless Steel



DE-2319
Height Gauge 0.22
Stainless Steel



DE-2320
Moveable
Height Gauge



DE-2321
Endo Finger
Ruler Span
Measure Scale

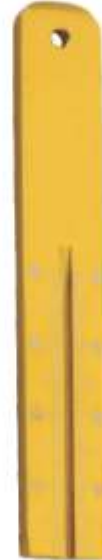

DE-2322
Endo Finger
Ruler Span
Measure Scale



DE-2323
Endo Finger
Ruler Span
Measure Scale



DE-2324
Positive
Postioner



DE-2325
Strip Saw



DE-2326
Bone Bracket Gauge



DE-2327
Endo Finger Ruler
Span Measure Scale



DE-2328
Endo Finger Ruler
Span Measure Scale



- Инструменты ортодонтические
- Instrumentos Ortodonticos
- Orthodontische Instrumente
- Инструменти ортодонтични
- Instruments Orthodontiques
- أدوات تقويم الأسنان



DE-2329
Boley Gauge



DE-2330
Vernier Gauge



DE-2331
Aluminium Caliper
up to 200mm



DE-2332
Boley Gauge



DE-2333
Delux Boley
Gauge



DE-2334
Beerendonk
130mm
Mini Gauge



DE-2335
Compasso
De Willis



DE-2336
Dentaureum
Ruler



DE-2337
Ruler Wedge



DE-2338
Ruler

- Инструменты ортодонтические
- Instrumentos Ortodonticos
- Orthodontische Instrumente
- Инструменти ортодонтични
- Instruments Orthodontiques
- أدوات تقويم الأسنان

Bracket Holder Tweezers



DE-2339
Deluxe Bracket
Holder Tweezers



DE-2340
Deluxe Bracket
Holder Tweezers



DE-2341
Direct Bond Bracket
Holder Tweezers



DE-2342
Bracket Tweezers
Slot Aligner



DE-2343
Direct Bond
Bracket Holder
Tweezers, Small Tip



DE-2344
Exact Bracket
Holder Tweezers



DE-2345
Bracket Placing
Tweezers



DE-2346
Easy Access
Tweezers



DE-2347
Bracket Placer
Tweezers
(Extra Fine Tip)



DE-2348
Deluxe Bracket
Holder Tweezers
135mm



DE-2349
Easy Eccess
Tweezers



DE-2350
Slipper
Tweezers



DE-2351
Direct Bonding
Bracket Holders
135mm



DE-2352
Direct Bonding
Bracket Holders
136mm



DE-2353
Direct Bonding
Bracket Holders
135mm



DE-2354
Deluxe Bracket
Holder



DE-2355
Direct Bonding
Bracket Holders
140mm



ORTHODONTIC INSTRUMENTS

- Инструменты ортодонтические
- Instrumentos Ortodonticos
- Orthodontische Instrumente
- Инструменти ортодонтични
- Instruments Orthodontiques
- أدوات تقويم الأسنان



DE-2356
Band seater
auto cleavable



DE-2357
Band seater
auto cleavable
Triangle Shape



DE-2358
Band seater
auto cleavable
Square Shape



DE-2359
Band seater
auto cleavable
Round Shape



DE-2360
Mershon Band
Pusher
140mm



DE-2361
Band seating &
removing
instruments



DE-2362
Ortho Light double
ended
ligature director
scaler



DE-2363
Ortho Light Band
Pusher
Scaler



DE-2364
Band Seating &
Removing
Silicon Grip



DE-2365
Ligature Instrument
Silicon Grip



DE-2366
Elastic Instrument
Silicon Grip



DE-2367
Distal Bender
Silicon Grip



DE-2368
Distal Bender
Silicon Grip



DE-2369
Distal Bender
Silicon Grip



ORTHODONTICS PLIERS STANDS

- Ортодонтия Щипцы Подставки
- Supports de pinces d'orthodontie
- Kieferorthopädie Zangenständer
- Ортодонтия Щипці Підставки
- KFO Zangen Ständer
- تقويم الأسنان كمشاشة تلف



DE-2370
Plier Stand
Stainless Steel.



DE-2371
Plier Stand
Stainless Steel.



DE-2372
Pliers Stand
Stainless Rod
(Aluminum Anodized)
Stainless Steel



DE-2373
Plier Stand
Stainless Steel.



DE-2374
Plier Stand
Stainless Steel.



DE-2375
Plier Stand
Plastic



- Инструменты для имплантологии
 - Implantologie
 - Implantologie
- Инструменти для имплантології
 - Implantologia
 - زراعة الأسنان

Composite Filling Instruments Set of 6 Pcs



DE-2376



DE-2377



DE-2378



DE-2379



DE-2380



DE-2381

COMPOSITE INSTRUMENTS USE:

A composite (tooth colored) filling is used to repair a tooth that is affected by decay, cracks, fractures, etc. The decayed or affected portion of the tooth will be removed and then filled with a composite filling.

There are many types of filling materials available, each with their own advantages and disadvantages. You and your dentist can discuss the best options for restoring your teeth. Composite fillings, along with silver amalgam fillings, are the most widely used today. Because composite fillings are tooth colored, they can be closely matched to the color of existing teeth, and are more aesthetically suited for use in front teeth or the more visible areas of the teeth.

As with most dental restorations, composite fillings are not permanent and may someday have to be replaced. They are very durable, and will last many years, giving you a long lasting, beautiful smile.

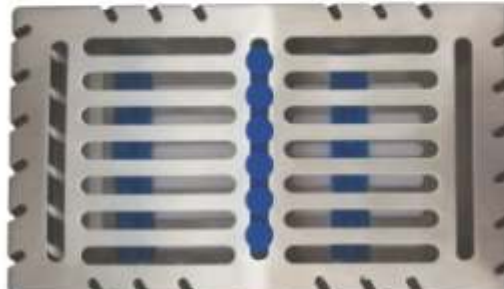

DE-2382



IMPLANTOLOGY

- Инструменты для имплантологии
- Implantologie
- Implantologie
- Инструменти для имплантології
- Implantologia
- زراعة الأسنان

Set of 5 Composite Gold Tip Instruments
DE-2383



Set of 4 Composite Blue Tip Instruments
DE-2384



Set of 3 Composite Blue Tip Instruments
DE-2385



Set of 2 Composite Blue Tip Instruments
DE-2386



DE-2387 Periosteal Elevators Molt # 9

DE-2388 Endodontic explorer DG # 16



IMPLANTOLOGY

- Инструменты для имплантологии
- Implantologie
- Implantologie

- Инструменти для имплантології
- Implantologia
- زراعة الأسنان



DE-2389
Sinus Lift elevator 1



DE-2390
Sinus Lift elevator 2



DE-2391
Sinus Lift elevator 3



DE-2392
Sinus Lift elevator 4



DE-2393
Sinus Lift elevator 5



DE-2394
Sinus Lift elevator 6



DE-2395
Sinus Lift Elevators Set of 7 Pcs
with cassette

IMPLANTOLOGY

- Инструменты для имплантологии
 - Implantologie
 - Implantologie
- Инструменти для имплантології
 - Implantologia
 - زراعة الأسنان

Sinus Left Elevator Set of 10 Pcs

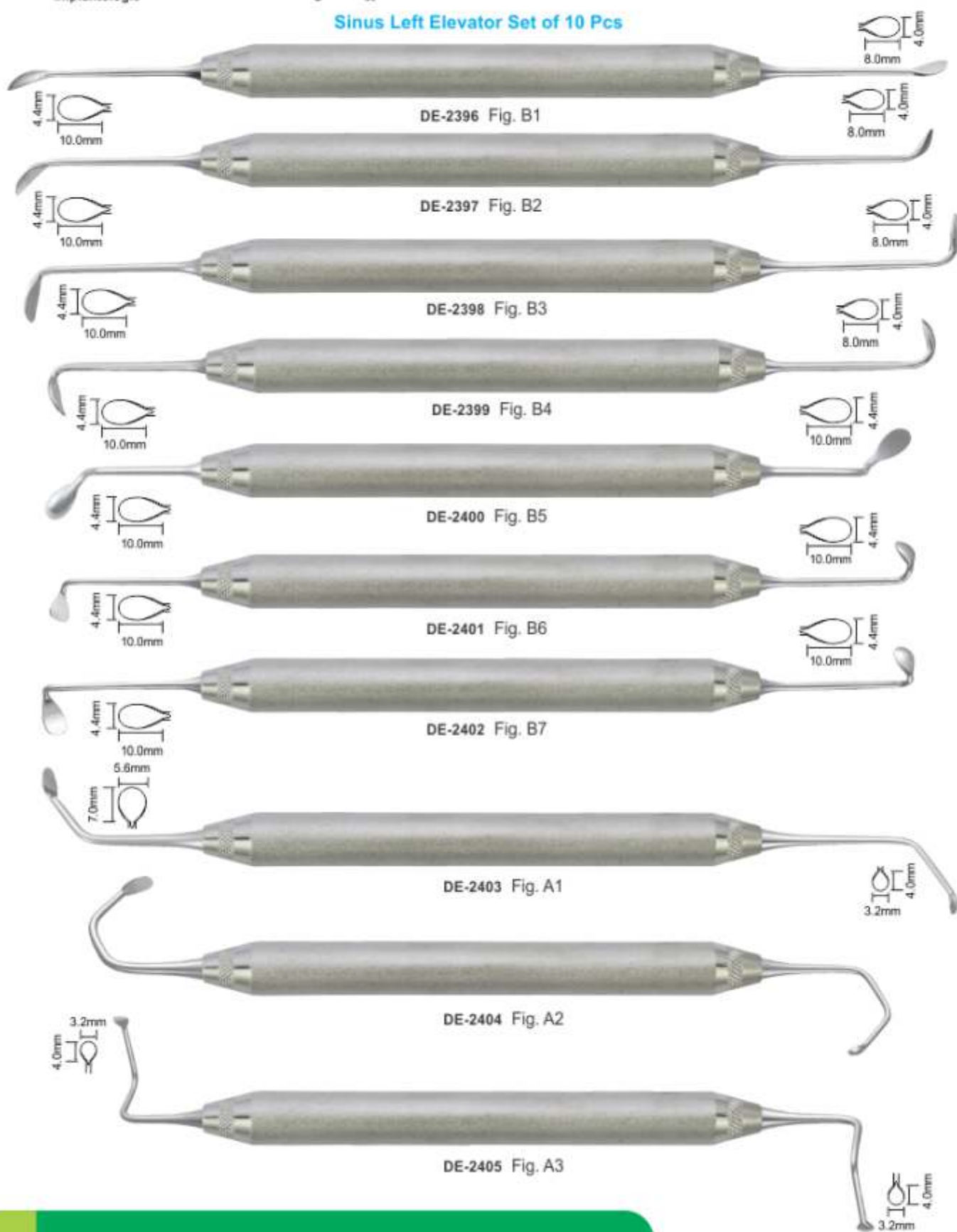

- Инструменты для имплантологии
- Implantologie
- Implantologie

- Инструменти для имплантології
- Implantologia
- زراعة الأسنان

IMPLANT SINUS LIFT INSTRUMENTS HOLLOW HANDLE 9.5MM LENGTH 170MM

SINUS LIFT INSTRUMENTS HOLLOW HANDLE 9.5MM LENGTH 170MM



DE-2406
Acute 6577

DE-2407
Sinus1

DE-2408
Sinus2

DE-2409
Sinus 3
Obtuse 6578

DE-2410
Sinus 4

DE-2411
Sinus 5

DE-2412
Sinus 6

DE-2413
Sinus 7



9 Pcs of Set
DE-2414

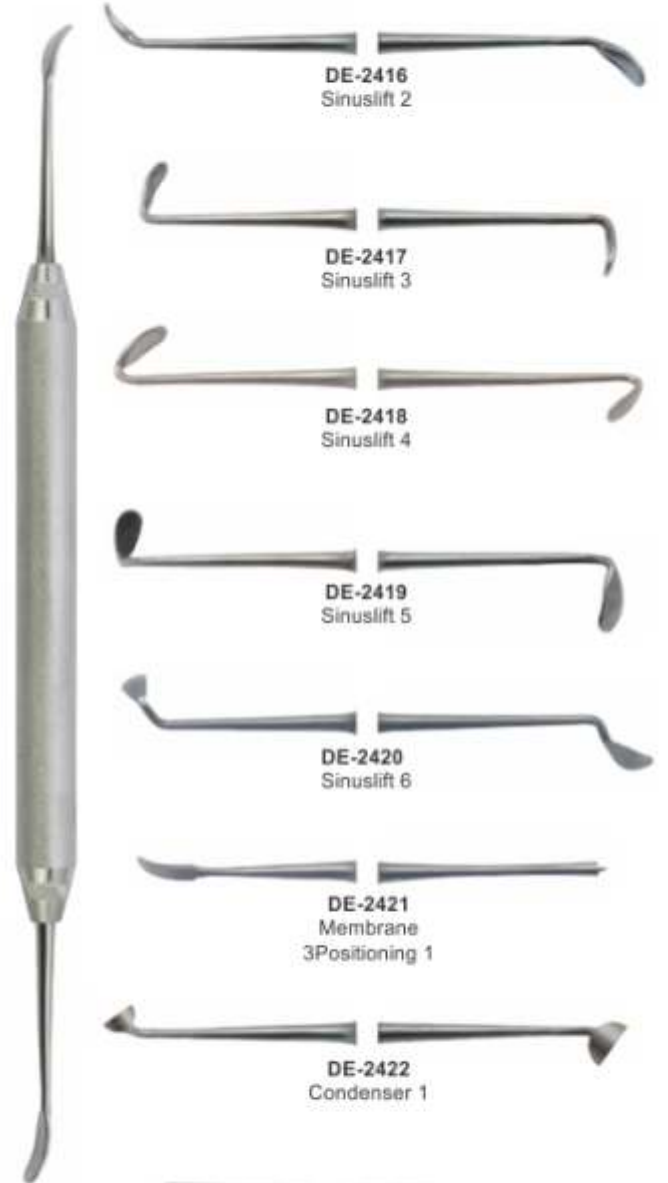

DE-2415
Sinuslift 1

DE-2416
Sinuslift 2

DE-2417
Sinuslift 3

DE-2418
Sinuslift 4

DE-2419
Sinuslift 5

DE-2420
Sinuslift 6

DE-2421
Membrane
3Positioning 1

DE-2422
Condenser 1



9 Pcs of Set
DE-2423

IMPLANTOLOGY

- Инструменты для имплантологии
 - Implantologie
 - Implantologie
- Инструменти для имплантології
 - Implantologia
 - زراعة الأسنان

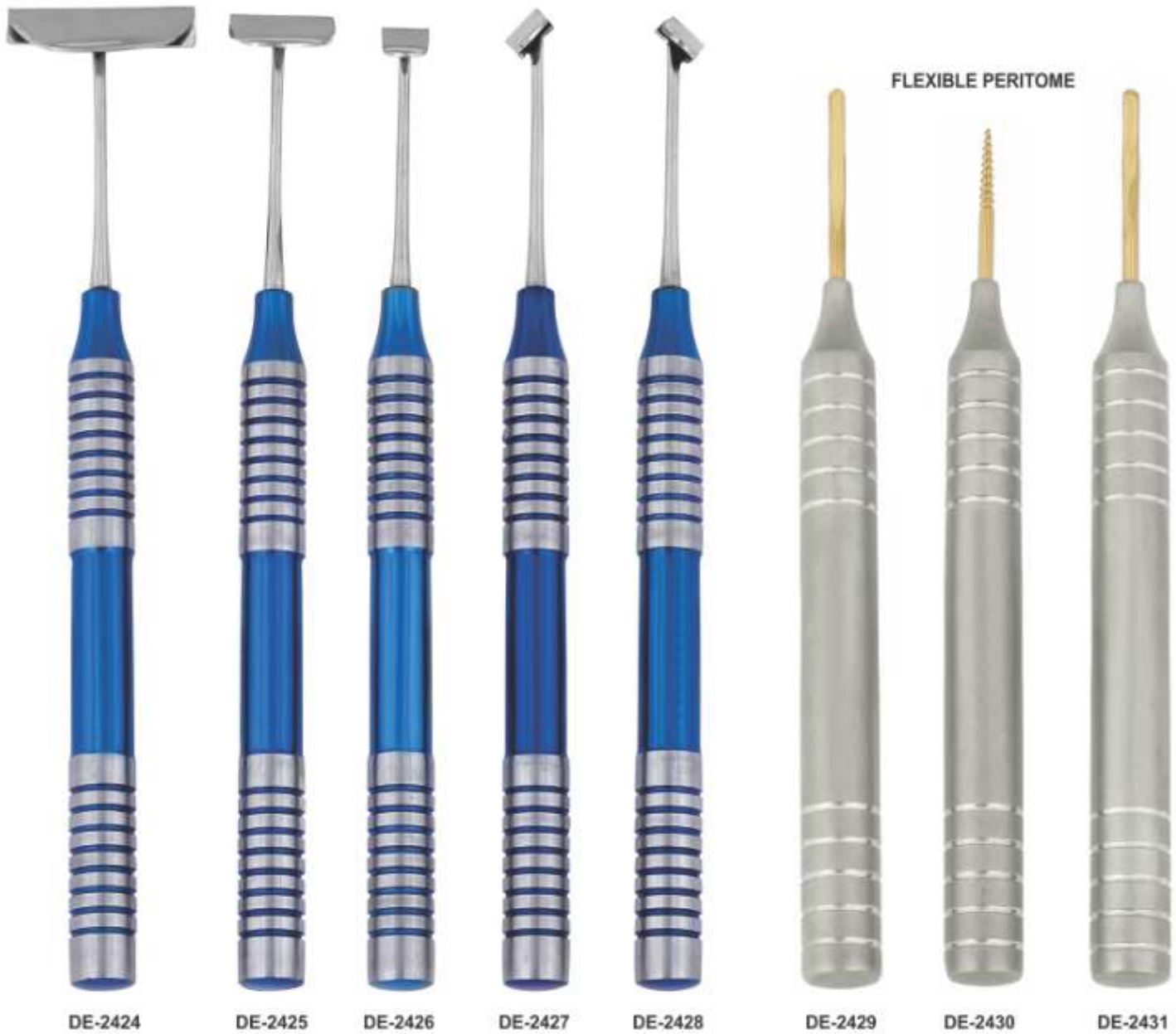

Soft Brushing Kit Set of 6 Pcs



- Инструменты для имплантологии
 - Implantologie
 - Implantologie
- Instrumenti для имплантології
 - Implantologia
 - زراعة الأسنان

SINUS ELEVATOR & MEMBRANE LIFT TIPS

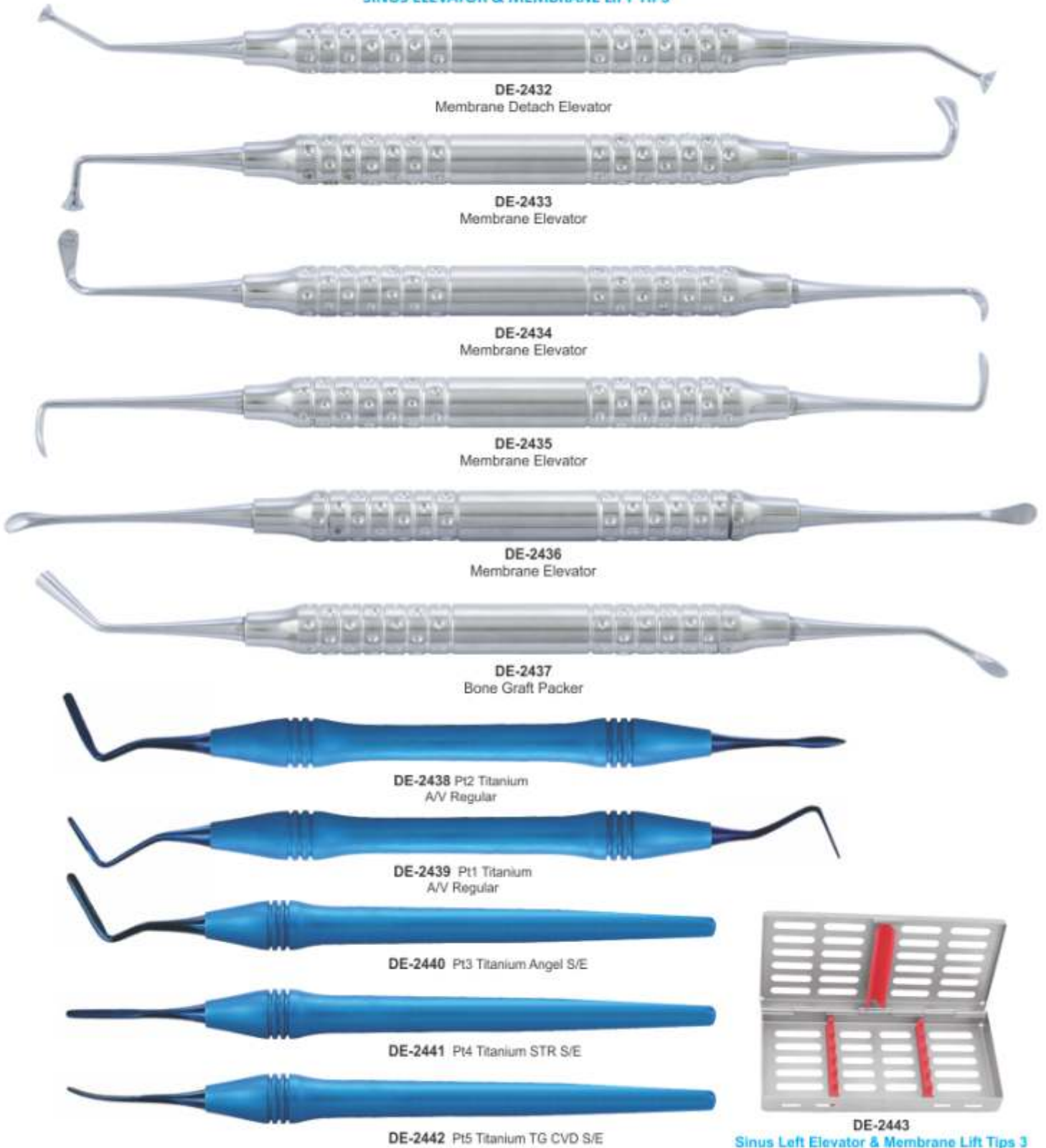

DE-2443
Sinus Left Elevator & Membrane Lift Tips 3
set of 7 Pcs



**Spirit Lamp
DE-2444**



**Spirit Lamp
DE-2445**



**Spirit Lamp
DE-2446**



**Cotton Holding Jar
DE-2447**



**Cotton Holder
DE-2448**



**Cotton Holder
DE-2449**



**Cotton Wool Dispenser Acc.
to Methot
DE-2450**



**Needle Sterillization Tub
DE-2451**



**Round Endodontic Boxes
complete with lid
DE-2452 Ø mm. 94 - h. mm. 70**



**Endodontic Box
DE-2453**





DE-2454
100 x 180 x 11mm
Mini size



DE-2455
100 x 180 x 11mm
Mini size



DE-2456
100 x 180 x 11mm
Mini size



DE-2457
100 x 180 x 11mm
Mini size



DE-2458
100 x 180 x 11mm
Mini size



Lid
Coperchio
DE-2459
103 x 182 x 10mm
Mini size



DE-2460
Silver



DE-2461 Blue
DE-2462 Red



DE-2463 Blue
DE-2464 Red



DE-2465
Silver



DE-2466
Green



DE-2468
Blue



DE-2467
Golden



DE-2469
Red



DE-2470
Silver



DE-2471
Midi
125 x 105 x 54mm



DE-2472
Maxi
204 x 105 x 54mm

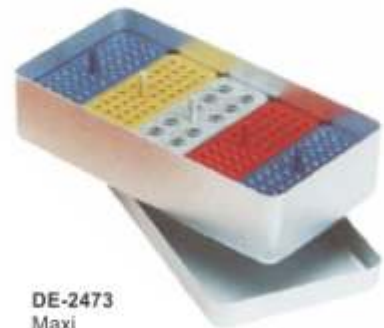

DE-2473
Maxi
204 x 105 x 54mm

STERILIZING MESH TRAY

Different sizes & dimensions are available at buyer's demand



**MESH TRAYS
DE-2474**

Different sizes & dimensions are available at buyer's demand



**MESH TRAYS
DE-2475
05 Pcs**



**MESH TRAYS
DE-2476
07 Pcs**



**MESH TRAYS
DE-2477
10 Pcs**



**MESH TRAYS
DE-2478
20 Pcs**



**DE-2479
Mesh Cassettes
5 Pieces, 7 Pieces, 10 Pieces,
15 Pieces & 20 Pieces**



MESH TRAY
DE-2480 240x130x50mm
DE-2481 240x130x60mm
DE-2482 240x250x50mm
DE-2483 240x250x60mm
DE-2484 480x250x50mm
DE-2485 480x250x60mm
DE-2486 480x250x70mm



MESH TRAY
DE-2487 240x250x 50mm
DE-2488 240x250x 60mm
DE-2489 240x250x 70mm
DE-2490 480x250x 50mm
DE-2491 480x250x 60mm
DE-2492 480x250x 70mm
DE-2493 480x250x100mm



MESH TRAY
DE-2494 240x250x50mm
DE-2495 240x250x60mm
DE-2496 240x250x70mm
DE-2497 280x250x50mm
DE-2498 280x250x60mm



MESH TRAY
DE-2499 280x250x 70mm
DE-2500 280x250x100mm
DE-2501 280x250x 50mm
DE-2502 280x280x 60mm
DE-2503 280x280x 70mm
DE-2504 300x280x 60mm





EXPLORERS

- Зонды
- Sondes
- Zahnsonden
- Зонди
- Sondas
- المستكشفين

PROBES

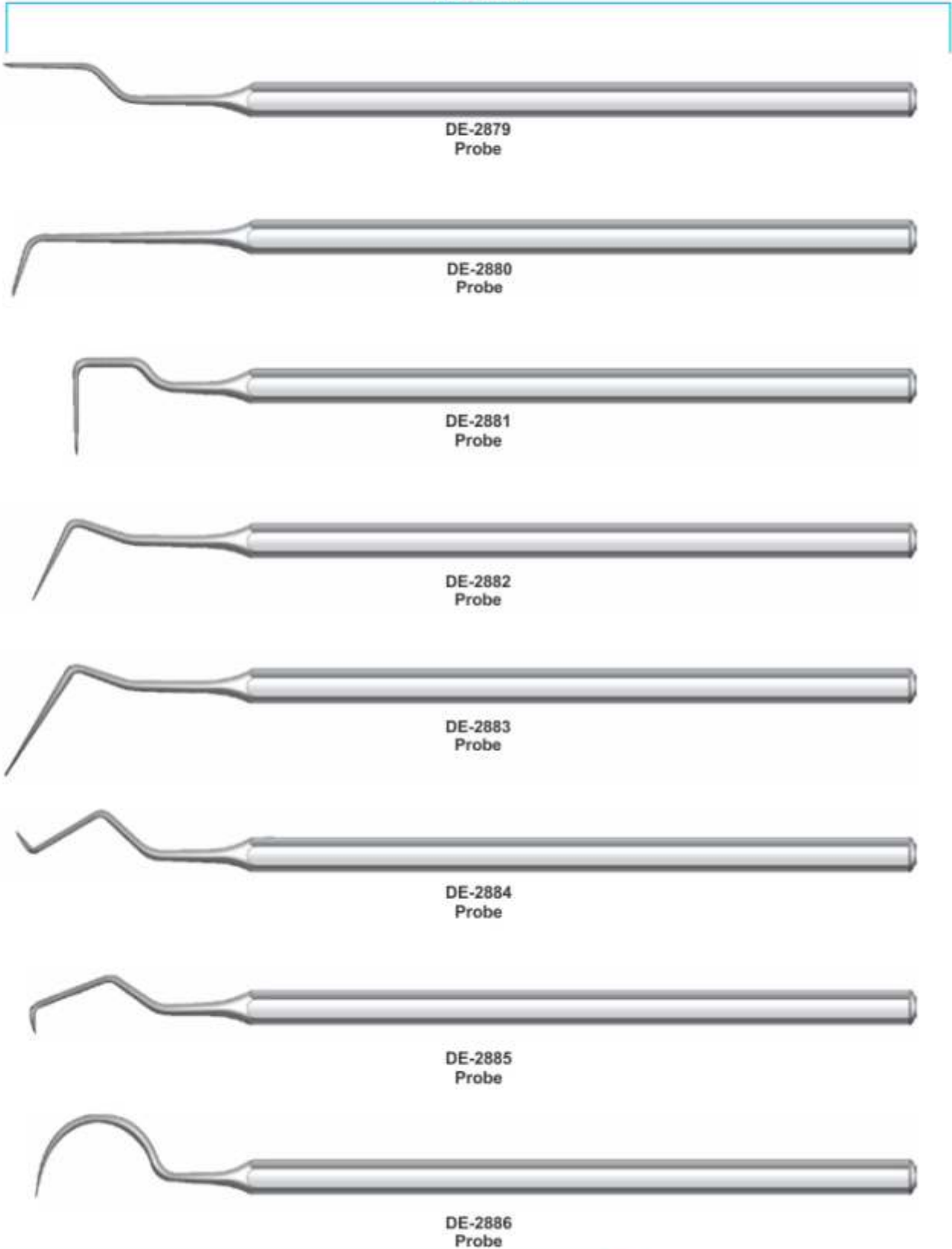

INCHES
0 1 2 3 4 5 6 7 8 9

PERIODONTAL INSTRUMENTS

- Инструменты пародонтологические
- Instruments pour la parodontologie
- Instrumente für die Parodontologie

- Інструменти пародонтологічні
- instrumentos para periodoncia
- الصكوك اللثة



PERIODONTAL INSTRUMENTS

- Инструменты пародонтологические
- Instruments pour la parodontologie
- Instrumente für die Parodontologie

- Інструменти пародонтологічні
- instrumentos para periodoncia
- الصكوك للتة

MODELLING INSTRUMENTS

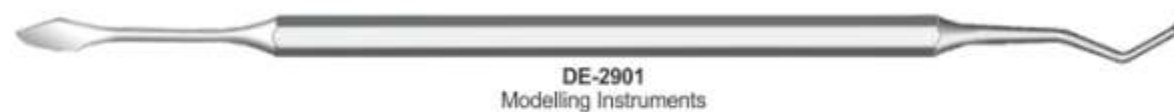

PERIODONTAL INSTRUMENTS

- Инструменты пародонтологические
- Instruments pour la parodontologie
- Instrumente für die Parodontologie

- Инструменти пародонтологічні
- instrumentos para periodoncia
- الصكوك اللثة

Periodontal Instruments Set



Cotton Meriam Tweezer

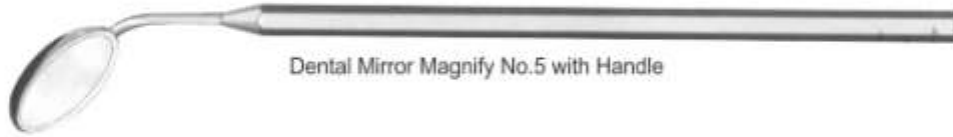

Dental Mirror Magnify No.5 with Handle

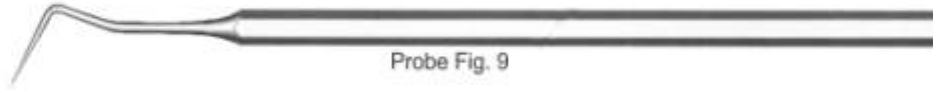

Probe Fig. 9



Excavator Tip Size Ø2mm-1,5mm



Excavator Tip Size Ø1,2mm-1,5mm



Plugger Tip Size Ø1,5mm-2mm



Plugger Tip Size Ø2mm-2,5mm



Ironing Crescent Tip Size Ø3mm-3,2mm



Ironing Crescent Tip Size Ø2,5mm-2,5mm



Cement Spatula Tip Size 6mm



DE-2904
Set of 10 Pieces.



DENTAL INSTRUMENTS SETS



(also available in color coated)
DE-2905 PDL Elevators (Set of 7-Pcs.)



DE-2906
Examination
Set of 3-Pcs.



DE-2907
Examination
Set of 3-Pcs.



DE-2908
Examination
Set of 3-Pcs.



DE-2909 Dental Lab Instruments Set of 10-Pcs.



DE-2910 Cleaning Kit of 10-Pcs.



DE-2911
Dental Head Mirrors



DE-2912
Dental Flasks Press



DE-2913
Crown & Bridge Articulator



DE-2914
Galetti adjustable Articulators



- DE-2915** Orthodontic Wire of 15 Meters Size: 0.4mm
- DE-2916** Orthodontic Wire of 15 Meters Size: 0.5mm
- DE-2917** Orthodontic Wire of 15 Meters Size: 0.6mm
- DE-2918** Orthodontic Wire of 15 Meters Size: 0.7mm
- DE-2919** Orthodontic Wire of 15 Meters Size: 0.8mm
- DE-2920** Orthodontic Wire of 15 Meters Size: 0.9mm
- DE-2921** Orthodontic Wire of 15 Meters Size: 1.0mm



DE-2922
Dental Lab
Gas Burner



DE-2923
Endo Finger Ruler



DE-2924
Endo Finger Ruler



DE-2925
Dental Napkin Holder /
Dental Bib Clip Plastic.



(Napkin Holder)
(Ball Chain)
DE-2926
Dental Napkin Holder /
Ball Chain Adjustable



Flexible Periotome Dental Extraction Screw
DE-2927 Kit Luxating Elevators 6-Pcs. "ASIM Brand"



**DE-2928 "ASIM'S
Tunneling Forceps"**

For Pulling Tissue Graft Through Tunnel
Micro Thin For Uninterrupted Passage
Through Tunnel 75 Degree Angle For All
Areas And Applications Pressure Limiting
Spring Prevents Damage To Graft
Diamond Coated For Slip Resistance



DE-2929 Soldering Tweezers
DE-2930 Serrated Tips Fiber
Grip Heat Resistant



DE-2931
Manual Crown Remover with 3-Tips



DENTAL INSTRUMENTS SETS



A



B



C

DE-2932
Dental Anesthesia Syringe
1.8 ml (in Multi Colors)



D



E



F

DE-2933
Dental Anesthesia Syringe
1.8 ml (in Multi Colors)



G



H



I

DE-2934
Dental Anesthesia Syringe
1.8 ml (in Multi Colors)



DE-2935
Dental Syringe 1. ½ Ring
Cork Screw Tip



DE-2936
Dental Syringe -Ring
Cork Screw Tip



DE-2937
Knives for Wax



DE-2938
Knives for Wax



DE-2939
Spoon Curettes D_end with Mash Point



A



B



C



D



E



DE-2940
Crown Remover



DE-2941
Wire Cutter Pliers
(screw joint)



DE-2942
Wire Cutter Pliers
(box joint)



DENTAL INSTRUMENTS



DE-2943
Hair scissors 175mm



DE-2944
Scissors For dressing
235mm



DE-2945
Dissecting Scissors, Intestinal, Straight, 205mm



DE-2946
Dental Mallet (Brass)



DE-2947
Dental Mallet (Brass)



DE-2948
Root Fragments Forceps
Fig.1 straight Fig.2 Curved



DE-2949
Dental cutter
for gypsum
170mm RSG



DE-2950
Dental Scissors 190mm



DE-2951
Dental Spoon



DE-2952
Neurological Mallets for
the study of tendon Mallets



DE-2953
Diamond Disks
Safety Guard 7/8



DE-2954
Heister Mouth Gag 5"



DE-2955
Castroviejp Scleral Marker



DE-2956 Zurichr Measuring Caliper



SURGICAL INSTRUMENTS



DE-2957 Scalpel Knife Large Cb 160x50



DE-2958 Scalpel Knife Small Cbr 145x32



DE-2959 Scalpel Knife Medium 150x42



DE-2960 Scalpel Knife Medium Cb 150x40



DE-2961 Scalpel Knife Medium 153x47



DE-2962 Scalpel Knife, sharp-pointed medium 150x40



DE-2963 Scalpel Knife 130x20 Cb-2 VP



DE-2964 Scalpel Knife 130x20 Cb-2



DE-2965 Ophthalmic Scalpel sharp-pointed medium 130x20



DE-2966 Resection Knife Convex 165x55



DE-2967 Knife Costal Cartilage 205mm



DE-2968 Amputation Knife, small 250x120



DE-2969 Amputation Knife, Large 315x180



DE-2970
Lucae Tweezers 14cm 140x1,5



DE-2971
Lucae Kocher Tweezers 14cm 140x1,5



DE-2972
14mm Physician
Dental Dentist
Laryngeal Mouth
Mirror 8 mm



DE-2973
Round Mirrors handle
with Adjustment



DE-2974
Physician Dental
Dentist Laryngeal
Mouth Mirror 12mm



DE-2975
Physician Dental
Dentist Laryngeal
Mouth Mirror 15mm



DE-2976
Physician Dental
Dentist Laryngeal
Mouth Mirror 21mm



DE-2977
Physician Dental
Dentist Laryngeal
Mouth Mirror 25mm



DE-2978
Physician Dental
Dentist Laryngeal
Mouth Mirror 27mm



DE-2979
Chisel Otorhinolaryngological
(4x150mm), wide Grove handle

DE-2980
Chisel Otorhinolaryngological
(2x150mm), wide Grove handle

DE-2981
Chisel Otorhinolaryngological
(4x150mm), wide Grove handle

DE-2982
Chisel Otorhinolaryngological
(6x150mm), wide Grove handle

DE-2983
Chisel Otorhinolaryngological
(8x150mm), wide Grove handle



DE-2984
Adenotome No. 1



DE-2985 Wire Probe Curved Sharp Blunt Point



DE-2986 Wire Probe Curved Sharp Single Point



DE-2987 Dental Probe Blunt Single Point





Russian Type Speculums

DE-2988 (small) Vaginal Speculum No.1

DE-2989 (Medium) Vaginal Speculum No.2



DE-2990 (Large) Vaginal Speculum No.3



DE-2991 Nasal Mirror 22mm

DE-2992 Nasal Mirror 30mm DE-2994 Nasal Mirror 40mm
DE-2993 Nasal Mirror 35mm DE-2995 Nasal Mirror 60mm



DE-2996 Uterine Tenaculum Forceps 250mm



DE-2997 Spoon Curettes Gynecologic double-ended



DE-2998 Volkman Gynecological Spoon, double-end



DE-2999 Curette No.1 DE-3000 Curette No.2 DE-3001 Curette No.3



DE-3002 Tongue Depressor (Double sided spatulas)



DE-3003 Russian Type Impression Trays Set of (6-Pcs.)

Impression Trays Upper
DE-3004 No.1 Upper 1
DE-3005 No.2 Upper 2
DE-3006 No.3 Upper 3

Impression Trays Lower
DE-3007 No.1 Upper 1
DE-3008 No.2 Upper 2
DE-3009 No.3 Upper 3

DE-3010 Vaginal Speculum Simsu No.1
DE-3011 Vaginal Speculum Simsu No.2
DE-3012 Vaginal Speculum Simsu No.3
DE-3013 Vaginal Speculum Simsu No.4
DE-3014 Vaginal Speculum Simsu No.5



DE-3015 Vaginal elevator-speculum OTTO (100x30)



DE-3016 Forceps Sponge Forester Str. & Cvd. 25cm / 12mm



DE-3017 Ear Funnel, nickel-plated No.1
DE-3018 Ear Funnel, nickel-plated No.2
DE-3019 Ear Funnel, nickel-plated No.3
DE-3020 Ear Funnel, nickel-plated No.4

DE-3021 Spoon Curettes D_End with Point 3mm, 3.5(Putty Cut)

DE-3022 Bone Chisels (Files) No.1 (3mm) No.1 (3mm)



DE-3023 Dental Chisel No.2 4mm



DENTAL INSTRUMENTS SETS



DE-3024
Tooth Extracting
Forceps UK-Type
Set of 10 Pcs.
Fig. 1
Fig. 7
Fig. 13
Fig. 17
Fig. 18
Fig. 22
Fig. 51A
Fig. 67
Fig. 74N
Fig. 79



DE-3025
Dental Implant Locator
Depth Pin Gauge Guide
Locating Plate
S-type & type.



DE-3026
Rubber Dam Clamps
Set of 15 Pcs.



DE-3027
Rubber Dam Clamps
Set of 16 Pcs.



DE-3028
Klein Set of 7 Pcs.
Fig. 3, Fig. 5, Fig. 6, Fig. 7,
Fig. 51S, Fig. 137, Fig. 139



DE-3029
Impression Trays Solid
Set of 6-Pcs.



DE-3030
Impression Trays Perforated
Set of 8-Pcs.



DE-3031
Disposable Impression Trays
(plastic) Set of 10-Pcs.



DE-3032
Dental Extracting
Physics Forceps
Set of 4-Pcs.



DE-3033
Dental Extracting
Physics Forceps
Set of 4-Pcs.





DE-3034
Gracey Curette (Set of 7-Pcs.)
Hollow Handle with color coated



DE-3035
Silicone Handle Dental Composite
Filling Instruments Kit 7-Pcs.



DE-3036
Gracey Curette (Set of 6-Pcs.)
Aluminum Handle color coated

DE-3037 Plugger Machtou 1/2 (0.5mm x 0.6mm) Red Silicone
DE-3038 Plugger Machtou 3/4 (0.8mm x 1.0mm) Grey Silicone



DE-3039
Hemingway Bone Curettes Set of
4 Hollow Handle with color coated



DE-3040
Plugger Dentsply 1/3 Silicon Handle Yellow Color
DE-3041
Plugger Dentsply 2/3 Silicon Handle in Red Color



DE-3042
Lucas Bone Curette D-Ended Set of
4 Spoons Hollow Handle color coated



DE-3043
Dental Filling Instruments Set of 5-Pcs.
Plane Hollow Handle Point Color Coated



DE-3044
P.K. Thomas Set of 5-Pcs.
Hollow Handle color coated



DE-3045
P.K. Thomas Set of 5-Pcs.
Solid Handle



DE-3046
Dental Filling Instruments Set of
6-Pcs. Solid Handle 6mm D-End



DE-3047
Composite Dental Instruments kit 6-Pcs.
Titanium Coated Composite Scalar Set



DE-3048
Composite Dental Instruments kit 6-Pcs.
Titanium Coated Composite Scalar Set





DE-3049
Bur Box



DE-3050
Rubber Dam Template Sheet



DE-3051
Fox Measuring Plate "Set of 2"



DE-3052
Tray Sterilizer 190x100x30



DE-3053
Tray Sterilizer 190x70x25



DE-3054
Tray Sterilizer
200x150x30



DE-3055
Tray Sterilizer
90x45x17



DE-3056
Instruments Tray 12 Pcs.



DE-3057
Instruments Tray 8Pcs.



DE-3058
Endodontic Box with Double Cap 200mm x 100mm



IMPLANTOLOGY

- Инструменты для имплантологии
 - Implantologie
 - Implantologie
- Інструменти для імплантології
 - Implantologia
 - زراعة الأسنان



DE-3059
Drills kit (Black Coated)
 The Kit Includes:
Dental Drills Implant Kit 8 Pcs
Drill Sizes:
 2.0mm, 2.5mm, 2.8mm, 3.2mm,
 3.65mm, 4.2mm, 5.2mm, 5.5mm
 Marking Depths on the drills
 for accurate drilling.
 Sizes 6.0mm, 8.0mm, 10.0mm,
 11.5mm, 13.0mm & 16.0mm.



DE-3060
Drill Kit (Polished)
 The Kit Includes:
Dental Drills Implant Kit 8 Pcs
Drill Sizes:
 2.0mm, 2.5mm, 2.8mm, 3.2mm,
 3.65mm, 4.2mm, 5.2mm, 5.5mm
 Marking Depths on the drills
 for accurate drilling.
 Sizes 6.0mm, 8.0mm, 10.0mm,
 11.5mm, 13.0mm & 16.0mm.

- The Kit Includes:
- 1.8mm Pilot Drill
 - 1525 (2.0mm)
 - 2535 (3.0mm)
 - 3545 (4.0mm)
 - 4555 (5.0mm)
 - 1828 (2.3mm)
 - 2838 (3.3mm)
 - 3848 (4.3mm)
 - 4858 (5.3mm)
 - 2228 (2.5mm)
 - 3238 (3.5mm)
 - 4248 (4.5mm)
 - 5258 (5.5mm)



DE-3061
Osseodensification Burs Kits



IMPLANTOLOGY

- Инструменты для имплантологии
 - Implantologie
 - Implantologie
- Инструменти для имплантології
 - Implantologia
 - زراعة الأسنان



DE-3062 Compression Expander Screws Kit

The Kit Includes:

Kit Includes

3x Bone Compression Screws

1x Sinus Elevation Screw (3.5mm)

Screws are compatible with any brands 4.0mm Torque Wrench /

Ratchet Wrench / Adapter's

Kit Advantages

Screws are Laser marked to indicate the depth of 8mm, 10mm & 13mm



DE-3063 Hex Drivers Adapter Kit

The Kit Includes:

4 Pcs Hex Drivers Kit Fits Ratchet / Torque Wrench

2 x 25mm & 2x 2.5mm Long & Short Driver

Manufactured from High Grade Stainless Steel -

Highly Polished



DE-3064

Bone Expander Kit

The Kit Includes:

1) Expander Screws

1.6 / 2.6 mm, 1.9 / 3.0 mm, 2.1 / 3.4 mm

2.6 / 3.8 mm, 2.9 / 4.3 mm

With Laser Depth Markings on 8mm, 10mm & 11.5mm.

2) Saw Disks

7.0 mm, 10.0 mm

3) Pilot Drill 1.6mm

4) Hand piece Adapter

5) Ratchet Extender

6) Hand Driver

7) Ratchet Wrench 4.0mm

8) Sterilization Cassette / Box.



DE-3065

Bone Compact Kit

The Kit Includes:

1) Twist Drills

2.0mm, 2.5mm, 2.8mm 3.2mm,

3.65mm, 4.2mm, 5.2mm

With Laser Depth Markings

on 6.0mm, 8.0mm, 10.0mm,

11.5mm, 13.0mm & 16.0mm

2) Ratchet / Wrench Hex Drivers

(Color Coded)

1.25mm Short / Long, 2.42mm Short / Long

3) Contra Angle Hex Drivers

1.25mm, 2.42mm

4) Parallel Pins Long & Short

5) Drill Extender

6) Marking Drill

7) Ratchet Wrench 6.35mm

8) Sterilization Cassette / Box / Organizer



IMPLANTOLOGY

- Инструменты для имплантологии
 - Implantologie
 - Implantologie
- Инструменти для имплантології
 - Implantologia
 - زراعة الأسنان



DE-3066

Trimmer Kit

The Kit Includes:

1) Trephine Drills

- 3.0mm, 4.0mm
- 5.0mm, 6.0mm
- 7.0mm

2) Tissue Punch

- 3.5mm, 4.0mm
- 4.5mm, 5.0mm
- 5.5mm

3) Guide Punch

- 4.0mm, 5.0mm

4) Saw Disks

- 7.0mm, 10.0mm

5) Sterilization Cassette.



DE-3067

Bone Compression Kit

The Kit Includes:

Convex Compression Screws

- 1.6/2.7mm, 2.0/3.3mm
- 2.4/3.6mm, 3.1/4.1mm

Concave Compression Screws

- 3.0mm, 3.5mm, 4.0mm

Spade Marking Drill

- Motor Mount Drivers Long & Short
- Hand Driver
- Ratchet Adapter
- Ratchet Wrench



DE-3068

Surgical Drill Kit

The Kit Includes:

1) Twist Drills

- 2.0mm, 2.8mm
- 3.2mm, 3.65mm
- 4.2mm, 4.8mm, 5.2mm

With Laser Depth Markings on 6.0mm, 8.0mm, 10.0mm, 11.5mm, 13.0mm & 16.0mm

2) Ratchet / Wrench Hex Drivers (Color Coded)

- 1.25mm Short / Long, 2.42mm Short / Long

3) Parallel Pins

- Long & Short

4) Motor Mount Hex

- 1.25mm, 2.5mm

5) Ratchet Wrench 4mm

6) Sterilization Cassette / Box / Organizer



IMPLANTOLOGY

- Инструменты для имплантологии
- Implantologie
- Implantologie
- Инструменти для імплантології
- Implantologia
- زراعة الأسنان

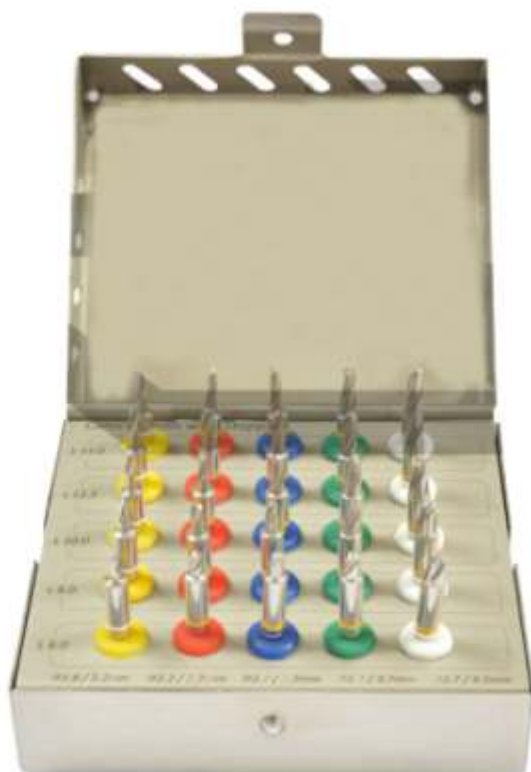

DE-3069

Universal Kit 50 PCS

The Kit Includes:

16pcs Conical Drills with Stoppers

- 1.8mm / 2.2mm - S1, 1.8mm / 2.2mm - S3
- 1.8mm / 2.2mm - S5, 1.8mm / 2.2mm - S7
- 2.2mm / 2.7mm - S1, 2.2mm / 2.7mm - S3
- 2.2mm / 2.7mm - S5, 2.2mm / 2.7mm - S7
- 2.3mm / 3.3mm - S1, 2.3mm / 3.3mm - S3
- 2.3mm / 3.3mm - S5, 2.3mm / 3.3mm - S7
- 2.8mm / 4.5mm - S1, 2.8mm / 4.5mm - S3
- 2.8mm / 4.5mm - S5, 2.8mm / 4.5mm - S7

S = Stopper Length

Bone Expander Screws

- 1.6mm / 2.6mm, 1.9mm / 3.0mm
- 2.9mm / 3.4mm, 2.3mm / 3.8mm
- 2.9mm / 4.3mm,

Titanium Coated Drills

- Drill Bit 2.0mm L 18.50, Drill Bit 2.8mm L 18.50
- Drill Bit 3.65mm L 18.50, Drill Bit 4.2mm L 18.50
- Drill Bit 4.5mm L 18.50, Drill Bit 4.8mm L 18.50
- Drill Bit 5.2mm L 18.50

8pcs Trephine Drills

- Int: 2.0mm, Ext: 3.0mm, Int: 3.0mm, Ext: 4.0mm
- Int: 4.0mm, Ext: 5.0mm, Int: 5.0mm, Ext: 6.0mm
- Int: 6.0mm, Ext: 7.0mm, Int: 7.0mm, Ext: 8.0mm
- Int: 8.0mm, Ext: 9.0mm, Int: 9.0mm, Ext: 10.0mm
- Compression Screw 2.8 / 4.0mm, Compression Screw 4.0mm
- Driver 2.5mm

Compression Screw 2.0 / 2.8mm, Compression Screw 2.8 / 3.4mm

Tissue Punch 4.5mm, Tissue Punch 5.8mm

Pilot Drill 2.0mm

Drill Extender

Ratchet Driver 2.5mm, Hand Driver 2.5mm

Torque Wrench 6.35mm (10-40Ncm)

Depth Gauge

Sterilization Cassette / Box

DE-3070

Conical Implant Drill Kit

The Kit Includes:

Drills Sizes:

- 1.8mm / 2.2mm, 2.2mm / 2.7mm
- 2.3mm / 3.3mm, 2.7mm / 3.7mm
- 2.7mm / 4.5mm

Stopper Sizes:

- 1.0mm / L 13.0, 2.0mm / L 11.5
- 3.0mm / L 10.0, 5.0mm / L 8.0
- 7.0mm / L 6.0

Overall Drills Length:

13.0mm (32mm with Shaft)





Manufacturers & Exporter of Surgical Instruments
Roras Road, Muzafar Pur, 51310,
Sialkot Pakistan

Tel: +92 52 3254190, Fax: +92 52 3257067
E.mail: info@mithubro.com
URL: www.mithubro.com